



Rialtas na hÉireann
Government of Ireland

Building Regulations

Technical Guidance Document B 2024

Fire Safety – Volume 1

Buildings other than Dwelling Houses

Prepared by the Department of
Housing, Local Government and Heritage

[gov.ie/housing](https://www.gov.ie/housing)

© Government of Ireland 2024

Table of Contents

Contents

List of Diagrams	
List of Tables	
Introduction	1
Transitional Arrangements	1
The Guidance	2
Existing Buildings	2
Technical Specifications	3
Materials and Workmanship	3
Interpretation	3
Part B: The Requirement	4
Section 0 Use of the Guidance	5
0.1 Introduction	5
0.1.1 Fire Safety Objectives	5
0.1.2 Scope of This Guidance.....	5
0.1.3 Document Structure	5
0.1.4 Application of Part B.....	6
0.1.5 Arrangements of Sections	6
0.1.6 Application of the Guidance	7
0.1.7 Performance Statements	7
0.1.8 Codes of Practice or Standards	7
0.2 Alternative Approaches	8
0.3 Existing Buildings	8
0.4 Maintenance of Fire Safety Provisions	9
0.5 Purpose Groups	9
0.6 Fire Resistance and Reaction to Fire	10

Table of Contents

0.7	Active and Passive Protection	10
0.8	Commissioning	10
0.9	Requirement to Provide User Information	12
0.10	Definitions	12
	Section 1 Means of Warning and Escape in Case of Fire	22
1.1	Introduction to Provisions	22
1.1.1	General	22
1.1.2	Analysis of the Problem	22
1.1.3	Criteria for Means of Escape.....	23
1.1.4	Unprotected and Protected Escape Routes	24
1.1.5	Progressive Horizontal Escape in Residential (Care Facility) Buildings (Purpose Group 2(a))	24
1.1.6	Security Measures	24
1.2	Use of This Document for the Design of Means of Escape	25
1.2.1	Hospitals	25
1.2.2	Stadiums, Grandstands or Other Outdoor Spectator Accommodation	26
1.3	Methods of Measurement	27
1.3.1	Capacity Calculation Method	27
1.3.2	Measurement of Width	27
1.4	Design for Horizontal Escape	29
1.4.1	Introduction	29
1.4.2	Number of Escape Routes and Exits	29
1.4.3	Planning of Escape Routes and Exits	34
1.4.4	Corridors	41
1.4.5	Evacuation Considerations for Residential (Care Facility) Buildings, (Purpose Group 2(a)(ii))	46
1.4.6	External Escape Routes.....	49
1.4.7	Audience and Spectator Facilities	50
1.4.8	Premises Provided with a Stage	53

Table of Contents

1.4.9 Student Accommodation Unit (Purpose Group 2 (b))	55
1.5 Design for Vertical Escape.....	57
1.5.1 Introduction	57
1.5.2 Number of Escape Stairways	57
1.5.3 Single Escape Stairways.....	58
1.5.4 Width of Escape Stairway	59
1.5.5 Calculation of Minimum Stairway Width	61
1.5.6 Protection of Escape Stairways.....	65
1.5.7 Basement Stairways	67
1.5.8 Protected Lobbies and Corridors to Escape Stairways	69
1.5.9 External Escape Stairways.....	71
1.6 Means of Escape from Flats (Purpose Group 1 (c)).....	73
1.6.1 Introduction	73
1.6.2 Internal Planning of Flats	73
1.6.3 Maisonettes.....	81
1.6.4 Escape Windows.....	84
1.6.5 Alternative Exits from Flats	85
1.6.6 Horizontal Means of Escape in Common Parts of Flats	85
1.6.7 Vertical Means of Escape in Common Parts of Flats	93
1.6.8 Ancillary Accommodation	94
1.7 Means of Escape from Shopping Centres	96
1.7.1 Introduction	96
1.7.2 Units.....	97
1.7.3 Malls	100
1.7.4 Stairs and Final Exits from a Shopping Centre.....	103
1.7.5 Ancillary Accommodation	104
1.7.6 Wayfinding and Spatial Orientation.....	105
1.8 Small Premises (Offices and Shops).....	106

Table of Contents

1.8.1 Construction.....	106
1.8.2 Travel Distance and Number of Escape Routes	106
1.8.3 Escape Stairs in Small Premises	108
1.9 General Provisions for Means of Escape.....	109
1.9.1 Introduction	109
1.9.2 Protection of Escape Routes.....	109
1.9.3 Doors on Escape Routes	110
1.9.4 Construction of Escape Stairways.....	113
1.9.5 Height of Escape Routes	114
1.9.6 Floors of Escape Routes	114
1.9.7 Final Exits	115
1.9.8 Lighting of Escape Routes	115
1.9.9 Lifts	117
1.9.10 Electrical Installations and Protected Circuits.....	119
1.9.11 Refuse Chutes and Storage	119
1.9.12 Fire Safety Signs.....	120
1.9.13 Fire Detection and Alarm Systems.....	120
1.9.14 Provision of Refuge Areas in Buildings	124
1.9.15 Fixed Hose Reels.....	126
1.9.16 Heat-Producing Appliances.....	126
Section 2 Internal Fire Spread (Linings).....	130
2.1 Introduction to Provisions	130
2.1.1 Fire Spread and Lining Materials	130
2.1.2 Floors in Firefighting Shafts	130
2.1.3 Classification of Performance.....	131
2.2 General Provisions	132
2.2.1 Surfaces Excluded from the General Provisions	132
2.2.2 Variation and Special Provisions.....	133

Table of Contents

2.3	Thermoplastic Materials	134
2.3.1	Glazing.....	135
2.3.2	Roof lights	135
2.3.3	Lighting Diffusers	135
Section 3 Internal Fire Spread (Structure).....		138
3.1	General.....	138
3.2	Introduction to Provisions.....	138
3.3	Load-Bearing Elements of Structure.....	139
3.3.1	Fire Resistance of Structural Elements	139
3.3.2	Application of Fire Resistance for Load-Bearing Elements	139
3.3.3	Exclusions from the Provisions for Fire Resistance.....	140
3.3.4	Additional Provisions for Load-Bearing Elements.....	140
3.3.5	Raised Storage Areas in Industrial or Storage Buildings	141
3.4	Compartmentation	143
3.4.1	Introduction	143
3.4.2	Forms of Compartmentation.....	143
3.4.3	Compartment Junctions	143
3.4.4	Provision of Compartment Walls and Compartment Floors.....	143
3.5	Construction of Compartment Floors and Compartment Walls	151
3.5.1	Performance Requirements for Compartment Walls and Compartment Floors	151
3.5.2	Compartment Floors in Residential (Care Facility) Buildings	151
3.5.3	Compartment Floors in Shopping Centres	151
3.5.4	Compartment Floors in Buildings > 11 m	151
3.5.5	Compartment Walls.....	152
3.5.6	Separating Walls.....	152
3.5.7	Accommodation of Services in Compartment Walls/Floors	152
3.5.8	Separated Parts	153
3.5.9	Compartment Junctions	153

Table of Contents

3.5.10	Junction of a Compartment Floor with an External Wall	154
3.5.11	Junction of a Compartment Wall with an External Wall	156
3.5.12	Opposite Elevations of the Same Building	157
3.5.13	Junction of Compartment Wall and Roof	158
3.5.14	Roof Characteristics at Compartment Wall Junction	160
3.5.15	Openings between Compartments	161
3.5.16	Protected Shafts.....	161
3.6	Concealed Spaces (Cavities)	166
3.6.1	Introduction	166
3.6.2	Provision of Cavity Barriers	166
3.6.3	Maximum Dimensions of Concealed Spaces	168
3.6.4	Performance of Cavity Barriers	169
3.6.5	Openings in Cavity Barriers.....	170
3.7	Protection of Openings	171
3.7.1	Introduction	171
3.7.2	Openings for Pipes.....	171
3.7.3	Ventilation Systems.....	173
3.7.4	Flue Walls, Ducts Containing Flues, Appliance Ventilation Ducts	178
3.7.5	Fire-Stopping	179
3.8	Special Provisions	180
3.8.1	Introduction	180
3.8.2	Car Parks	180
3.8.3	Buildings Containing an Atrium	181
Section 4	External Fire Spread	190
4.1	General.....	190
4.2	Introduction to Provisions.....	190
4.3	External Walls	191
4.3.1	Introduction	191

Table of Contents

4.3.2 Fire Resistance of External Walls	191
4.3.3 Restriction of Fire Spread on External Walls.....	192
4.3.4 Roofs with a pitch at 70° or more to the horizontal.....	196
4.3.5 Portal Frames.....	196
4.4 Space Separation	197
4.4.1 Introduction	197
4.4.2 Boundaries.....	197
4.4.3.Unprotected Areas and Fire Resistance	200
4.4.4 External Walls within 0.5 m of a Boundary	201
4.4.5 External Walls between 0.5 m and 1 m of the Relevant Boundary.....	201
4.4.6 External Walls 1 m or More from the Relevant Boundary.....	201
4.4.7 Buildings Containing Atria	206
4.5 Roof Coverings	207
4.5.1 Introduction	207
4.5.2 Other Controls on Roofs	207
4.5.3 Classification of Performance.....	207
4.5.4 Separation Distances	207
4.5.5 Plastic Rooflights.....	207
4.5.6 Glass in Rooflights	208
4.5.7 Solar Panels on Roofs	208
Section 5 Access and Facilities for the Fire Service.....	210
5.1 General.....	210
5.2 Introduction to Provisions	210
5.3 Fire Mains	211
5.3.1 Introduction	211
5.3.2 Internal Fire Mains	211
5.3.3 External Fire Mains and Hydrants	212
5.4 Vehicle Access.....	216

Table of Contents

5.4.1 Introduction	216
5.4.2 Buildings not Fitted with an Internal Fire Main.....	216
5.4.3 Buildings Fitted with Fire Mains.....	218
5.4.4 Design of Access Routes and Hardstandings	218
5.5 Personnel Access to Buildings for Firefighting	221
5.5.1 Introduction	221
5.5.2 Basements	221
5.5.3 Buildings with a Topmost Floor < 11 m	222
5.5.4 Buildings with a Topmost Floor > 11 m but < 20m	222
5.5.5 Buildings with a Topmost Floor > 20 m	223
5.5.6 Provision and Number of Firefighting Shafts	224
5.6 Areas Requiring Special Consideration	233
5.6.1 Boiler Rooms and Fuel Stores	233
5.6.2 Isolation of Electrical Supply for Firefighting.....	234
Section 6 Smoke Control Systems	236
6.1 Introduction.....	236
6.1.1 Use of this Section	236
6.1.2 Location of Wall-Mounted Vents	237
6.1.3 Mechanical Vents.....	237
6.1.4 Measurement of Natural Vents	238
6.1.5 Natural Vent to a Smoke Shaft.....	238
6.2 Protected Stairways.....	239
6.2.1 Ventilation of Common Protected Stairway Enclosures.....	239
6.2.2 Ventilation of Lobbies to Protected Stairways or lifts.....	239
6.3 Ventilation of Firefighting lobbies	240
6.3.1 Introduction	240
6.3.2 Natural Automatic Vents Opening Directly to the Exterior of the Building	240
6.3.3 Natural Automatic Vents Opening to Natural Smoke Shafts for Firefighting Lobbies above Ground	241

Table of Contents

6.3.4 Natural Automatic Vents Opening to Natural Smoke Shafts to Firefighting Lobbies below Ground.....	242
6.3.5 Mechanical Smoke Ventilation System.....	242
6.4 Buildings Containing Atria.....	243
6.4.1 Introduction.....	243
6.4.2 Smoke Clearance Systems.....	243
6.4.3 Smoke Control Systems.....	244
6.4.4 Pressure Differential Systems.....	245
6.5 Basements.....	247
6.6 Buildings Containing Flats.....	248
6.6.1 Introduction.....	248
6.6.2 Smoke Control System for Protected Corridors / Lobbies.....	248
6.7 Large Undivided or Windowless Spaces in Industrial or Storage Buildings.....	251
6.8 Car Parks.....	252
6.8.1 Car Parks.....	252
6.8.2 Ventilation of Open-Sided Car Parks.....	252
6.8.3 Ventilation of Non-Open-Sided Car Parks.....	252
6.9 Assembly and Recreation Buildings.....	254
6.9.1 Ventilation for Open Stages.....	254
6.9.2 Proscenium Stage Ventilation.....	254
6.10 Enclosed Shopping Centres.....	256
6.10.1 General.....	256
6.10.2 Mall Smoke Control.....	256
6.10.3 Unit Smoke Control.....	257
Section 7 Existing Buildings.....	258
7.0 Use of this Section.....	258
7.0.1 Introduction.....	258
7.0.2 Compensating Measures for Existing Buildings.....	258

Table of Contents

7.0.3 Fire Performance	260
7.1 Means of Escape	262
7.1.1 Application to Existing Building.....	262
7.1.2 Works to an Existing Building.....	262
7.1.3 Horizontal Escape	262
7.1.4 Vertical Escape	263
7.1.5 External Escape Routes.....	266
7.1.6 Construction of Escape Stairways.....	267
7.1.7 Small Premises	267
7.2 Internal Fire Spread (Linings)	268
7.2.1 Existing Surfaces – Assessment of Performance.....	268
7.3 Internal Fire Spread (Structure)	269
7.3.1 Works to Existing Buildings	269
7.3.2 Compartment Floors in Existing Residential (care facility) Buildings.....	269
7.3.3 Compartment Floors in Existing Buildings > 11 m.....	269
7.3.4 Fire Resistance of Timber Floors in Existing Buildings.....	270
7.3.5 Compartment Walls in Existing Buildings > 11 m.....	270
7.3.6 Doors in separating walls	271
7.3.7 External Cavity Walls	271
7.3.8 Maximum Dimension of Cavities	271
7.3.9 Openings for Pipes.....	272
7.4 External Fire Spread	274
7.4.1 External Walls Fire Spread.....	274
7.4.2 Portal Frames	274
7.4.3 Space Separation.....	274
7.4.4 Roof Coverings	275
7.5 Access and Facilities for the Fire Service.....	277
7.5.1 Material Alteration	277

Table of Contents

7.5.2 Material Change of Use	277
7.5.3 Access for Fire Appliances.....	277
7.5.4 Personnel Access to Buildings	278
7.5.5 Fire mains in existing buildings	278
7.6 Smoke Control Systems.....	279
7.6.1 Ventilation of Protected Stairways	279
7.6.2 Ventilation from Basements	279
Section 8 Sprinklers.....	280
8.1 Sprinkler Systems.....	280
8.2 Provision for Sprinkler Systems.....	280
8.3 References to sprinkler systems	282
8.4 Design of Sprinkler Systems.....	283
Appendix A	286
A1 Introduction.....	286
A2 Fire Tests.....	287
A3 Fire Resistance.....	287
A4 Fire-Resistance Performance	288
A5 Roof Coverings.....	290
A6 Reaction to Fire	290
A7 Reaction to Fire – Existing Buildings	292
A8 Thermoplastics	293
A9 Materials of Limited Combustibility (Existing Buildings)	294
A10 Non-Combustible Materials (Existing Buildings)	294
A11 Structural Fire Design	295
Appendix B: Fire Doors	288
B1 General.....	288
B2 Existing Buildings.....	289
B3 Self-Closing Devices.....	289

Table of Contents

B4 Insulation	290
B5 Fire Door Hardware	290
B6 Fire Safety Signs	291
B7 Identification	291
Appendix C: Methods of Measurement	295
C1 Methods of Measurement.....	295
Appendix D: Assessment of Fire Hazard and Associated Life Risk	302
D1 Assessment of Fire Hazard and Associated Life Risk	302
D2 Assessment of High Hazard	303
D3 Hazardous Materials.....	303
Appendix E: Standards and Publications	304
E1 National Standards Authority of Ireland	304
E2 British Standards Institution	309
E3 International Standards Organisation	311
E4 Building Research Establishment (BRE)	311
E5 Technical Guidance Documents	312
E6 National Directorate for Fire and Emergency management Publications	313
E7 Publications Referred to	313
Appendix F: Other Standards and Publications	314
F1 National Directorate for Fire and Emergency Management Publications.....	314
F2 Statutory Instruments.....	314
F3 Acts of the Oireachtas.....	314
F4 Fire Modelling	314
F5 Fire Doors and Shutters.....	314
F6 Passive Fire Protection	315
Appendix G: Other Design Documents	316
Appendix H: Summary of Requirements at Height	317

Table of Contents

List of Diagrams

Diagram 1 Door Widths.....	27
Diagram 2 Measurement of Travel Distance.....	31
Diagram 3 Alternative Escape Routes	33
Diagram 4 Inner Rooms.....	36
Diagram 5 Open Connections Between Floors	37
Diagram 6 Planning of Exits in a Central Core.....	38
Diagram 7 Escape from Galleries in Shops, Offices and Industrial Buildings	40
Diagram 8 Enclosure / Subdivision of Protected Corridors	42
Diagram 9 Subdivision of Corridors that are Not Protected	44
Diagram 10 Dead-End Corridors.....	45
Diagram 11 Progressive Horizontal Evacuation in Residential (Care Facility) Buildings.....	48
Diagram 12 Seatways and Gangways in Audience and Spectator Facilities	51
Diagram 13 Student accommodation unit	56
Diagram 14 Converging Flows at a Final exit.....	60
Diagram 15 External Protection to Protected Stairway	68
Diagram 16 Clearance Between Lobby Doors	70
Diagram 17 External Escape Stairways	72
Diagram 18 Flats With a Protected Entrance Hallway	75
Diagram 19 Open- Plan Flats, Travel Distance <9 m.....	76
Diagram 20 Open- Plan Flats With Sprinkler System	78
Diagram 21 Escape Windows / Alternative Exits From Open-Plan Flats	79
Diagram 22 Flats with Galleries	80
Diagram 23 Maisonettes - No floor more than 4.5 m above ground level	82
Diagram 24 Maisonettes with any floor more than 4.5m above ground level	83
Diagram 25 Single Stair Buildings, topmost floor height ≤ 11 m	86
Diagram 26 Separation of Basement Stairs.....	87
Diagram 27 Flats With an Open Deck Approach	88
Diagram 28 Flats with a Corridor / Lobby Approach - Single Stair	90

Table of Contents

Diagram 29 Flats with a Corridor / Lobby Approach - Multiple Stairs.....	91
Diagram 30 Flats with a Corridor / Lobby Approach - Multiple Stairs.....	92
Diagram 31 Final exit from a stairway	94
Diagram 32 Ancillary Accommodation in Buildings Containing Flats	95
Diagram 33 Alternate Means of Escape From Units	98
Diagram 34 Escape Routes Using Service Corridors	99
Diagram 35 Malls	100
Diagram 36 Widths of Mall Exits	102
Diagram 37 Travel Distance Within Malls	102
Diagram 38 Small Premises (Offices and Shops)	107
Diagram 39 Refuge Area Placed in a Protected Stairway.....	127
Diagram 40 Refuge Formed by Compartmentation	128
Diagram 41 Refuge on an External Escape Stairway	129
Diagram 42 Suspended Ceilings with a Fire Resistance	134
Diagram 43 Lighting Diffuser Locations in a Ceiling.....	136
Diagram 44 Layout Restrictions on TP (b) Thermoplastic Lighting Diffusers and Rooflights	136
Diagram 45 Elements of Structure Requiring Fire Resistance	141
Diagram 46 Compartment Walls and Compartment Floors	144
Diagram 47 Provision of Compartment Walls and Compartment Floors	148
Diagram 48 Junction of a Compartment Floor With an External Wall	155
Diagram 49 Junction of a Compartment Wall With an External Wall	157
Diagram 50 Junction of Compartment Wall With Roof.....	159
Diagram 51 Construction of Protected Shafts	164
Diagram 52 Glazed Screen Separating Protected Shaft From Lobby or Corridor.....	165
Diagram 53 Interrupting Concealed Spaces (Cavity Barriers).....	167
Diagram 54 Cavity Barriers in Double-Skinned Insulated Roof and wall Sheeting.....	169
Diagram 55 Pipes Penetrating a Compartment Wall or Floor (Sleeving)	172
Diagram 56 Ventilation Systems Passing Through Fire-Resisting Elements	175

Table of Contents

Diagram 57 Flues and Compartment Walls and Floor	178
Diagram 58 Atrium in a Building Containing Flats.....	182
Diagram 59 Atrium in a Residential (Care Facility) Building.....	183
Diagram 60 Atrium in a Residential (Other) Building.....	184
Diagram 61 Atrium in a Shop, Assembly and Recreation or Other Non-residential Building	187
Diagram 62 Atrium in an Office	189
Diagram 63 Distinction Between Walls and Roofs	193
Diagram 64 Provision for External Surfaces of Walls.....	194
Diagram 65 Relevant & Notional Boundary.....	199
Diagram 66 Calculation of Extent of Unprotected Area.....	200
Diagram 67 Unprotected Areas Which may be Disregarded for Space-Separation Purposes.....	202
Diagram 68 Small Residential Building	204
Diagram 69 External Fire Spread – Atrium Buildings.....	206
Diagram 70 Limits on Spacing and Size of Plastic Rooflights Having a TP(b) Lower Surface	209
Diagram 71 External Fire Mains and Hydrants	215
Diagram 72 Building Perimeter	217
Diagram 73 Fire Appliance (High Reach) Access to Buildings.....	220
Diagram 74 Buildings Fitted With Internal Fire Mains	223
Diagram 75 Firefighting Shaft Components (Typical Arrangements).....	224
Diagram 76 Firefighting Shafts.....	231
Diagram 77 Firefighting Shafts in Buildings Containing Flats.....	232
Diagram 78 Measurement of Free Vent Area	238
Diagram 79 Smoke Outlet From Shallow Basements	247
Diagram 80 Measurement of Door Width in Existing Buildings	263
Diagram 81 - Maisonette in an existing building.....	265
Diagram 82 Escape via a Window to an Enclosed Rear Yard in an Existing Building	266
Diagram 83 Masonry Cavity Walls Excluded From Provisions for Cavity Barriers	272
Diagram 84 Enclosures for Drainage or Water Supply Pipes.....	273
Diagram 85 Firefighting Shafts in Existing Buildings.....	278

Table of Contents

Diagram 86 Signs	292
Diagram 87 Measurement of Areas	295
Diagram 88 Cubic Capacity	296
Diagram 89 Number of Storeys.....	297
Diagram 90 Height of a Building	298
Diagram 91 Height of Top Storey and Depth of a Basement	299
Diagram 92 Length of a Compartment Wall.....	300
Diagram 93 Atria	301

Table of Contents

List of Tables

Table 1 Classification of Buildings by Purpose Group	11
Table 2 Occupancy Load Factor	28
Table 3 Limitations on Travel Distances	32
Table 4 Minimum Number of Escape Routes.....	34
Table 5 Width of Escape Routes and Exits	35
Table 6 Gangway Seating.....	52
Table 7 Minimum Width of Escape Stairways	59
Table 8 Capacities of Stairways (Total Evacuation).....	63
Table 9 Minimum Aggregate Width of Stairways for Phased Evacuation	64
Table 10 Maximum Travel Distances in Small Premises	107
Table 11 Provision of Emergency Escape Lighting.....	116
Table 12 Provision of Fire Detection and Alarm System.....	122
Table 13 Reaction-to-fire Classifications.....	132
Table 14 Limitations Applied to Thermoplastic Lighting Diffusers in Suspended Ceilings and Thermoplastic Roof Lights	137
Table 15 Maximum Area and Cubic Capacity of a Building or Compartment.....	147
Table 16 Provision of Cavity Barriers.....	166
Table 17 Maximum Dimensions of Cavities	167
Table 18 Maximum Nominal Internal Diameter of Pipes	172
Table 19 Reaction-to-fire Classification for External Walls	193
Table 20 Permitted Unprotected Areas in Small Residential Buildings	204
Table 21 Permitted Unprotected Areas in Other Buildings or Compartments	205
Table 22 Limitations on Roof Coverings*	208
Table 23 Limitations on Plastic Rooflights.....	209
Table 24 Vehicle Access to Buildings with a Topmost Floor up to 20 m	217
Table 25 Vehicle Access Route Specifications	219
Table 26 Tests for Walls Forming Firefighting Shafts	227
Table 27 Provision of Foam Inlets.....	233

Table of Contents

Table 28 Reaction-to-fire Classifications.....	260
Table 29 Reaction-to-fire Classifications.....	261
Table 30 Width of Escape Routes and Exits in Existing Buildings	263
Table 31 Minimum Provisions of Fire Resistance Performance.....	296
Table 32 Minimum Periods of Fire Resistance for Elements of Structure	283
Table 33 Limitations on Fire-protecting Suspended Ceilings (see Table 31, Note 3)	284
Table 34 Limitations on the use of Uninsulated Fire-resisting Glazed Elements in Walls on Escape Routes (see Table 31, Note 10)	285
Table 35 Notional Designations of Roof Coverings.....	286
Table 36 Provisions for Fire Doors.....	293
Table 37 Limitations on the use of Uninsulated Fire-resisting Glazed Elements on Escape Routes – Doors (see Table 31, Note 10).....	294

Introduction

This document has been published by the Minister for Housing, Local Government and Heritage under Article 7 of the Building Regulations 1997.

It provides guidance in relation to Part B of the Second Schedule to the Building Regulations 1997, as amended. The guidance in this document applies to buildings other than dwelling houses.

This document should be read in conjunction with the Building Regulations 1997 to 2024 and other documents published under these Regulations.

In general, Building Regulations apply to the construction of new buildings and to extensions and material alterations to existing buildings. In addition, certain parts of the Regulations apply to existing buildings where a material change of use or a major renovation takes place. Otherwise, Building Regulations do not apply to buildings constructed prior to 1 June 1992.

Transitional Arrangements

This document applies to the design of works, or buildings in which a material change of use takes place, where the works or the change of use commence or take place, as the case may be, on or after 01 May 2025. Technical Guidance Document B – Fire Safety, dated 2006 (as amended), also ceases to have effect from that date. However, the latter document may continue to be used in the case of works or to a building in which a material change of use takes place, where the works commence or the change of use takes place, as the case may be, on or after 1 May 2025, and other than in a case where the structure of the external walls of the building has been erected not later than 30 April 2028—

- (a) a planning application for planning permission or approval under the Planning and Development Act 2000 (No. 30 of 2000) has been made,
- (b) a notice of a proposed development under Part 8 of the Planning and Development Regulations 2001 (S.I. No. 600 of 2001) has been given by a local authority under article 81 of those Regulations,
- (c) a fire safety certificate under the Building Control Regulations (S.I. No. 496 of 1997), in respect of the works or buildings, has been granted, or
- (d) a decision of An Bord Pleanála, under section 9(4) of the Act of 2016, in relation to grant of an application for permission for a strategic housing development, under section 4 of the Act of 2016, has been issued,

on or before 30 April 2025.

Introduction

The Guidance

The materials, methods of construction, standards and other specifications (including technical specifications) which are referred to in this document are those which are likely to be suitable for the purposes of the Regulations. Where works are carried out in accordance with the guidance in this document, this will, *prima facie*, indicate compliance with Part B of the Second Schedule of the Building Regulations.

However, the adoption of an approach other than that outlined in the guidance is not precluded, provided that the relevant requirements of the Regulations are complied with. Those involved in the design and construction of a building may be required by the relevant building control authority to provide such evidence as is necessary to establish that the requirements of the Regulations are being complied with.

In the case of an application for a fire safety certificate under the Building Control Regulations, it is necessary to demonstrate compliance with Part B of the Second Schedule to the Building Regulations.

Existing Buildings

In the case of material alterations or changes of use of existing buildings, the adoption without modification of the guidance in this document may not, in all circumstances, be appropriate. In particular, the adherence to guidance — including codes, standards or technical specifications — intended for application to new work may be unduly restrictive or impracticable. Buildings of architectural or historical interest are especially likely to give rise to such circumstances. In these situations, alternative approaches based on the principles contained in the document may be more relevant and should be considered.

Technical Specifications

Building Regulations are made for specific purposes, e.g. to provide, in relation to buildings, for the health, safety and welfare of persons; the conservation of energy; and access for people with disabilities. Technical specifications (including harmonised European Standards, European Technical Assessments, National Standards and Agrément Certificates) are relevant to the extent that they relate to these considerations.

Any reference to a technical specification is a reference to as much of the specification as is relevant in the context in which it arises. Technical specifications may also address other aspects not covered by the Building Regulations.

A reference to a technical specification is to the latest edition (including any amendments, supplements or addenda) current at the date of publication of this Technical Guidance Document. However, if this version of the technical specification is subsequently revised or updated by the issuing body, the new version may be used as a source of guidance, provided that it continues to address the relevant requirements of the Building Regulations.

A list of other standards and publications that deal with matters relating to this Part of the Building Regulations is included at the end of this document. These standards and publications maybe used as a source of further information, but do not form part of the guidance.

Materials and Workmanship

Under Part D of the Second Schedule to the Building Regulations, building work to which the Regulations apply must be carried out with proper materials and in a workmanlike manner. Guidance in relation to compliance with Part D is contained in Technical Guidance Document D.

Interpretation

In this document, a reference to a section, paragraph, appendix or diagram is, unless otherwise stated, a reference to a section, paragraph, appendix or diagram, as the case may be, of this document. A reference to another Technical Guidance Document is a reference to the latest edition of a document published by the Department of Housing, Local Government and Heritage under Article 7 of the Building Regulations 1997.

Diagrams used in this document are illustrative only. They articulate particular aspects relevant to the specific part or section of text of this document, and do not show all the particulars of construction that are required for compliance with all parts of the Second Schedule to the Building Regulations.

Introduction

Part B: The Requirement

Part B of the Second Schedule to the Building Regulations 1997 to 2024, provides as follows:

Means of warning and escape in case of fire	B1	A building shall be so designed and constructed that there are (a) appropriate provisions for the early warning of fire, and (b) adequate means of escape in case of fire from the building to a place of safety outside the building, capable of being safely and effectively used.
Internal fire spread (linings)	B2	For the purpose of inhibiting the spread of fire within a building, the internal linings (a) shall have, either a rate of heat release or a rate of fire growth and a resistance to ignition which is reasonable in the circumstances, and (b) shall offer adequate resistance to the spread of flame over their surfaces.
Internal fire spread (structure)	B3	1) A building shall be so designed and constructed that, in the event of fire, its stability will be maintained for a reasonable period. 2) (a) A wall common to two or more buildings shall be so designed and constructed that it offers adequate resistance to the spread of fire between those buildings. (b) A building shall be subdivided with fire-resisting construction where this is necessary to inhibit the spread of fire within the building. 3) A building shall be so designed and constructed that the unseen spread of fire and smoke within concealed spaces in its structure or fabric is inhibited where necessary.
External fire spread	B4	The external walls and roof of a building shall be so designed and constructed that they (a) afford adequate resistance to the spread of fire over the face of the building, and (b) afford adequate resistance to the spread of fire to and from neighbouring buildings.
Access and facilities for the fire service	B5	A building shall be so designed and constructed that there is adequate provision for access for fire appliances and such other facilities as may be reasonably required to assist the fire service in the protection of life.
Provision of Information	B12	Sufficient information on the system(s) installed in the building for the purpose of fire safety shall be provided to the building owner so that the building can be operated in order to protect the health and safety of the building occupants.

Section 0: Use of the Guidance

Section 0 Use of the Guidance

0.1 Introduction

0.1.1 Fire Safety Objectives

Building Regulations are made for specific purposes. Part B of the Second Schedule to the Building Regulations is primarily concerned with fire safety. The fire safety measures outlined in this guidance document are intended for the protection of life from fire.

0.1.2 Scope of This Guidance

Part B of the Second Schedule to the Building Regulations applies to all buildings. The detailed provisions set out in this document provide *prima facie* guidance for some of the more common building situations.

The use of this document is limited to:

- (a) Buildings, excluding dwelling houses (Purpose Groups 1(a), 1(b), or 1(d)) with a topmost floor level of not more than 60 m; or
- (b) Residential (care facility) buildings (Purpose Group 2(a)(ii)) excluding hospitals (Purpose Group 2(a)(i)) with a topmost floor of not more than 30 m.

The use of this guidance may not be appropriate in all circumstances for buildings below these threshold heights, such as very complex, or very unusual buildings. For such buildings, see 0.2.

For purpose group definitions, see [Subsection 0.5](#).

0.1.3 Document Structure

Technical Guidance Document B (Fire safety) is published in two volumes.

Volume 1 (this volume) contains guidance relating to all types of buildings other than dwelling houses.

Volume 2 contains guidance relating to dwelling houses only.

Section 0: Use of the Guidance

0.1.4 Application of Part B

This volume deals with the requirements of Parts B1 to B5, and B12 of the second schedule to the Building Regulations, which relate to buildings other than dwelling houses.

B1 aims to ensure that there is early warning of fire, and that there are satisfactory means of escape for persons in the event of fire in a building.

B2 aims to ensure that fire spread over the internal linings of buildings is inhibited.

B3 aims to ensure the stability of buildings in the event of fire, to ensure that there is a sufficient degree of fire separation within buildings and between adjoining buildings, and to inhibit the unseen spread of fire and smoke in concealed spaces in buildings.

B4 aims to ensure that external walls and roofs have adequate resistance to the spread of fire over their external surfaces so that they do not contribute to undue fire spread from one part of a building to another part of the same building, and so that spread of fire from one building to another is restricted.

B5 aims to ensure satisfactory access for fire appliances to buildings and the adequate provision of facilities in buildings to assist fire fighters in the protection of life.

B12 aims to ensure that of adequate information is provided upon completion to ensure that the building can be effectively managed having regard to its design.

0.1.5 Arrangements of Sections

The provisions set out in Sections 1 to 6 of this Document deal with different aspects of fire safety in a new building and in the extension to, and/or material alteration of and/or material change of use of an existing building.

Section 7 outlines some specific details relating to existing buildings only, where the provisions specified in Section 1 to 6 cannot be reasonably achieved.

The seven sections are as follows:

[Section 1](#) Means of warning and escape in case of fire

[Section 2](#) Internal fire spread (linings)

[Section 3](#) Internal fire spread (structure)

[Section 4](#) External fire spread

[Section 5](#) Access and facilities for the fire service

[Section 6](#) Smoke control systems

[Section 7](#) Existing Buildings

[Section 8](#) Sprinkler Systems

Section 0: Use of the Guidance

Under the provisions of Sections 1 to 7 of this document, there are a number of items that are common to one or more of the requirements of those sections. These items include a classification of purpose groups (see [Subsection 0.5](#)), fire performance of materials and structures, provisions regarding fire doors and guidance regarding methods of measurement.

For convenience, these and other appropriate items have been drawn together as appendices to this Document, as follows:

[Appendix A](#) Fire performance of Material and Structures

[Appendix B](#) Fire Doors

[Appendix C](#) Methods of Measurement

[Appendix D](#) Assessment of Fire Hazard Industrial and Storage Buildings

[Appendix E](#) Referenced Standards

[Appendix F](#) Referenced Publications

A list of other design documents are provided in [Appendix G](#).

A summary of requirements related to building height are provided in [Appendix H](#).

0.1.6 Application of the Guidance

Technical Guidance Document B provides guidance on the minimum level of provision to meet the requirements of Regulations B1 to B5, and B12. The provisions are interdependent on each other and should be applied in a holistic manner.

0.1.7 Performance Statements

Each section of this document begins with a performance statement which indicates how the requirements of Part B of the Building Regulations relating to specific elements of the building may be met. These statements incorporate the essential elements required to satisfy the Regulations, and they form the basis for the provisions contained in the guidance.

0.1.8 Codes of Practice or Standards

A reference to a code of practice, or a standard, is for the purpose of providing supporting guidance for specific provisions of this document.

Where such a reference is made, the relevant guidance contained within the code of practice or standard is that pertaining to the relevant provisions specified in this document.

A provision of a code of practice, or a standard, should not be applied in a manner that diminishes a specific provision or requirement set out in this Technical Guidance Document.

Section 0: Use of the Guidance

0.2 Alternative Approaches

This document, Technical Guidance Document B (TGD B) provides *prima facie* guidance on the minimum level of provision to meet requirements B1 to B5, and B12 for common non-complex buildings.

Designers may choose to adopt an approach other than this document. Designs for fire safety in buildings based on any document other than this document do not constitute *prima facie* means to compliance with Part B of the Second Schedule to the Building Regulations.

In using any alternative document, code of practice or any other method of compliance, the requirements of Part B of the Second Schedule to the Building Regulations should be proven.

As the height, depth or complexity of buildings increases, the risks due to fire presented to occupants and firefighters may also increase. Therefore, for tall, deep, or complex buildings outside the scope of this document (see [Para 0.1.2](#)), provisions which are reasonable and proportionate, and reflective of the risk presented by the particular building design, should be considered.

For the design of fire safety of buildings using any document other than this document, a non-exhaustive list of useful references are given in [Appendix G](#).

0.3 Existing Buildings

Where possible, existing buildings undergoing works should adhere to the provisions of Sections 1 to 6.

However, in existing buildings, there may be constraints that would not exist in a new building, and some variations to the provisions set out in Sections 1 to 6 of this document may be appropriate. These are set out in Section 7.

Where the provisions of Sections 1 to 7 cannot be reasonably achieved, or are not specifically addressed, alternative solutions may be employed.

Many fire safety provisions are interdependent and therefore should not be considered in isolation from each other. Where a particular provision outlined in this document cannot be practicably achieved, compensating alternative fire safety measures may be taken into account when assessing levels of compliance, depending on the nature and circumstances of each particular case. Such measures include active and/ or passive provisions.

Section 0: Use of the Guidance

0.4 Maintenance of Fire Safety Provisions

The Building Regulations do not relate to the management of fire safety in buildings.

The guidance contained in this document has been based on the assumption that buildings and systems will be maintained adequately and will function having regard to their end intended use.

It is not appropriate to specify management solutions of buildings as a compensation for performance of fire safety design.

0.5 Purpose Groups

Many of the provisions in this document are related to the use of the building. The use classifications are termed “purpose groups”, and from this it follows that the relevant purpose group should be decided before the provisions can be determined.

Purpose groups can apply to a whole building, or (where a building is compartmented) to a compartment in the building, and the relevant purpose group should be taken from the main use of the building or compartment.

In situations where there is more than one use involved in a building or compartment, each different use should be separately considered as belonging to a purpose group in its own right when it is:

- (a) a flat or maisonette; or
- (b) a car park; or
- (c) a storage area in a shop if the area of storage is more than one-half of the total floor area of the shop; or
- (d) in any other building, any ancillary use, if the area of the ancillary use is more than one-quarter of the total floor area of the building or part.

Some buildings may have two or more main uses that are not ancillary to one another, e.g. offices over shops from which they are independent. In such cases, each of the uses should be considered as belonging to a purpose group in its own right.

In other cases, and particularly in some large buildings, there may be a complex mix of uses. In such cases, it is necessary to consider the possible risk that one part of a complex may carry for another, and special measures to reduce the risk may be necessary.

[Table 1](#) sets out the purpose group classification.

Section 0: Use of the Guidance

0.6 Fire Resistance and Reaction to Fire

The fire resistance of an element of construction is a measure of its ability to withstand the effects of fire in one or more ways:

R - resistance to collapse, i.e., the ability to maintain load-bearing capacity (which applies to load-bearing members only);

E - resistance to fire penetration, i.e. an ability to maintain the integrity of the element (which applies to fire-separating elements); and

I - resistance to the transfer of excessive heat, i.e., an ability to provide insulation from high temperatures (which applies to fire-separating elements).

Reaction to fire is the measurement of how a material or system will contribute to the development and spread of a fire.

Requirement for fire resistance are specified throughout this document. The fire resistance performance requirement for any element of construction, whether loadbearing or not, is set out in Appendix A, [Table 31](#), and [Table 32](#).

0.7 Active and Passive Protection

Active protection includes provisions or systems which come into action on detection of fire (such as fire alarms, fire suppression systems, smoke control systems, etc.). Where life-safety systems (fire alarm, emergency lighting, sprinkler, etc.) are installed in a building, they should function having regard to their end intended use, including during a power failure. In this regard, the specific provisions of the appropriate design standards for the system should be followed.

Passive protection includes provisions which relate to the defence against fire provided by the fabric and construction of a building (such as floors and walls).

0.8 Commissioning

Any active system(s) installed for the purpose of fire safety in the building should be commissioned, tested and certified at completion so that the systems and their controls are left in the intended working order, and can operate effectively and efficiently.

Section 0: Use of the Guidance

Table 1 Classification of Buildings by Purpose Group			
Use	Group	Purpose for which a building or compartment of a building is used	
Residential (Dwellings) – Dwelling House	1(a) 1(b) 1(d)	Dwelling House < 4.5m Dwelling House > 4.5m Community Dwelling House	See Technical Guidance Document B - Fire Safety – Volume 2 – Dwelling Houses
Residential (Dwellings) – Flat (apartment)	1(c)	Separate and self-contained premises constructed or adapted for residential use and forming part of a building from some other part of which it is divided horizontally. ⁽¹⁾	
Residential (Care Facility)	2(a)	(i) Hospital, (ii) nursing home, home for old people or for children, school or other similar establishment used as living accommodation or for the treatment, care or maintenance of persons suffering from illness or mental or physical disability, where such persons sleep on the premises.	
Residential (Other)	2(b)	Hotel, hostel, guest building, residential college, hall of residence, student accommodation, and any other residential purpose not described above.	
Office	3	Premises used for the purpose of administration, clerical work (including writing, book keeping, sorting papers, filing, typing, duplicating, machine calculating, drawing and the editorial preparation of matter for publication; handling money (including banking and building society work), telephone system operation).	
Shop	4(a)	Premises used for a retail or wholesale trade or business (including retail sales by auction, self-selection and over-the-counter wholesale trading, the business of lending books or periodicals for gain and the business of a barber or hairdresser,) and premises to which the public is invited to deliver or to collect goods in connection with their hire, repair or other treatment, or where they themselves may carry out such repairs or other treatments.	
Shopping Centre	4(b)	A building which comprises a number of individually occupied premises to which common access is provided principally for the benefit of shoppers.	
Assembly and Recreation ⁽²⁾	5(a)	“place of assembly” includes— (i) a theatre, public library, hall or other building of public resort used for social or recreational purposes. (ii) a non-residential school or other educational establishment. (iii) a place of public worship. (iv) a public house, restaurant or similar premises used for the sale to members of the public of food or drink for consumption on the premises. (v) a sports pavilion, stadium, grandstand, or other spectator accommodation. (vi) a terminus, station or other facility for air, rail, road or sea travel.	
Day Centre ⁽²⁾	5(b)	A building used for the provision of treatment or care to persons where such persons do not stay overnight, such as (i) a pre-school, a crèche, a day nursery, or similar facilities for children, or (ii) any other day centre, including a GP or dental surgery, primary care centre, facilities for medical treatment, or other similar facilities.	
Industrial Normal Hazard ⁽³⁾	6(a)	Factories and other premises of normal hazard, used for manufacturing, altering, repairing, cleaning, washing, breaking-up, adapting or processing any article, generating power or slaughtering livestock.	
Industrial High Hazard ⁽³⁾	6(b)	Factories and other premises of high hazard, used for manufacturing, altering, repairing, cleaning, washing, breaking-up, adapting or processing any article, generating power or slaughtering livestock.	
Storage Normal Hazard ⁽³⁾	7(a)	Place for storage or deposit of goods or materials of normal hazard other than those described under 7(c)	
Storage High Hazard ⁽³⁾	7(b)	Place for storage or deposit of goods or materials of high hazard other than those described under 7(c)	
Car Park	7(c)	Car parks designed to admit or accommodate only cars, motorcycles passenger vehicles or other light goods vehicles, not more than 2,500 kilograms vehicle weight.	
Other non-residential	8	Any other non-residential purpose not included in any other purpose group	

Section 0: Use of the Guidance

Notes to Table 1:

- (1) A 'flat' also includes a 'maisonette'.
- (2) A building may not be treated as a place of assembly or as a day centre solely because it is a building to which members of the public are occasionally admitted.
- (3) [Appendix D](#) gives guidance on the assessment of hazard in industrial and storage buildings. The category of any such building will determine many of the fire safety provisions required.

0.9 Requirement to Provide User Information

Regulation B12 requires that the building owner is provided with information, so that the building can be operated in a way that protects the health and safety of its occupants.

On completion of the works, the owner of the building, or person who commissions the works should be provided with sufficient information about the active systems installed for the purposes of fire safety, and their maintenance requirements, so that the building can operate as designed in the event of a fire. Such active systems may include; a fire detection and alarm system, an emergency lighting system, a sprinkler system, a smoke control system, etc., and any device activated by such a system.

The owner should be provided with a suitable set of operating and maintenance instructions on the effective use and operation of the system(s).

The instructions should be directly related to the particular system(s) installed in the building.

0.10 Definitions

Access room: a room through which the only escape route from an inner room passes.

Appliance ventilation duct: a duct provided to convey combustion air to an appliance.

Access level: a level used for normal access to a building that either incorporates, or leads directly to, a place of safety.

Accommodation stairway: a stairway provided for the convenience of occupants and additional to that or those required for escape purposes.

Alternative escape routes: escape routes sufficiently separated either by direction, and space or by fire-resisting construction, to ensure that one escape route is still available should fire prevent access to or use of the other one.

Associated floor area: any floor area in an atrium building that is not separated from the atrium by construction having a fire resistance equal to that required for the elements of the structure of the building.

Atrium: (plural atria): a space within a building, not necessarily vertically aligned, passing through one or more compartment floors (other than enclosed lift wells, enclosed escalator wells, building service ducts, and enclosed stairways which are not classified as atria).

Section 0: Use of the Guidance

Atrium base: the plan area of the lowest floor level, bounded by lines projected down from the edge of the floor slab immediately above the lowest floor level within the atrium (see [Diagram 93](#)).

Basement storey: a storey which is below the ground storey or, where there is no ground storey, a storey the top surface of the floor of which is situated at such a level or levels that some point on its perimeter is more than 1.2 m below the level of the finished surface of the ground adjoining the building in the vicinity of that point. (However, see [Appendix A, A4\(1\)\(c\)](#), for concessions where the storey is considered to be a basement only because of a sloping site).

Bedroom: a room which is used as sleeping accommodation within a dwelling, residential (care facility) building or residential (other) building.

Boundary: the boundary of the land belonging to the building, or, where the land abuts a road, railway, canal or river, the centreline of that road, railway, canal or river (see [Diagram 65](#)).

Cavity barrier: A non-loadbearing vertically or horizontally oriented element designed to provide fire separation in a concealed space (cavity). For minimum performance of a cavity barrier, see [Table 31](#)

Ceiling: a part of a building, which encloses, and is exposed overhead in a room, or circulation space. The soffit of a roof light, excluding the frame, set in a ceiling should be included as part of the surface of a ceiling,

Circulation space: a space (including a protected stairway) mainly used as a means of access between a room and an exit from the building or compartment.

Common area: any part or area of a building occupied by or under the direct control of the owner/management of the building (e.g. stairways and publicly accessible corridors in buildings containing flats, mall areas and shared escape routes in shopping centres).

Common Open Deck: a walkway, open to the air on one or more sides, which forms part of the escape route from a building.

Compartment: (fire compartment): a building or part of a building, comprising one or more rooms, spaces or storeys, constructed to prevent the spread of fire to or from another part of the same building, or an adjoining building.

Compartment wall or floor: a fire-resisting wall/floor used in the separation of one fire compartment from another.

Concealed space (cavity): a space enclosed by the elements of a building (including a suspended ceiling) or contained within an element, but not a room, cupboard, circulation space, protected shaft or the space within a flue, chute, duct, pipe or conduit.

Section 0: Use of the Guidance

Covered shopping centre: a shopping centre that includes a covered mall, i.e. any mall section in which:

- (a) More than 15 m of the length of the mall is covered by a bridge or roof; or
- (b) More than 50% of its plan area is obscured (where the mall has an open slot above it, formed for example by projecting continuous canopies); or
- (c) In any other case at least 25% of its plan area is obscured by a roof or by floors, bridges, galleries or canopies.

Dead end: an area from which escape is possible in one direction only.

Defined escape route: See escape routes.

Direct distance: the shortest distance from any point within the floor area, measured within the external enclosures of the building, to the nearest storey exit, ignoring walls, partitions and fittings other than the enclosing walls / partitions to protected stairways.

Dwelling: a house or flat forming a separate unit of residential accommodation.

Emergency lighting: lighting provided for use when the power supply to the normal lighting fails.

Electro-magnetic or electro-mechanical hold open device: A device which will allow a door held open by it to close automatically in the event of any of the following:

- (a) Detection of smoke by automatic apparatus suitable in nature, quality and location.
- (b) Operation of a manually operated switch fitted in a suitable position.
- (c) Failure of the electricity supply to the device, apparatus or switch.
- (d) Operation of the fire alarm system.

Elements fixed to the external wall: Elements fixed to the outermost face of the building, which could contribute to fire spread on the façade, and which may include: an open balcony, a device for reducing heat gain, a solar panel or materials which support and contain growing media in a green wall.

Escape lighting: that part of the emergency lighting which is provided to ensure that the escape route is illuminated at all material times.

Section 0: Use of the Guidance

Escape route: a route by which a person may reach a place of safety, and, in relation to any point in a building, a route from that point to a place of safety. An escape route may comprise of one or more of the following:

- (a) Undefined escape routes: open areas in a building where the escape routes are not fixed or defined by the elements of construction.
- (b) Defined escape routes: routes, such as exits, escape corridors and escape stairways, through which or along which, persons may be required to travel to reach a final exit from a building.
- (c) External escape routes: those parts of an escape route outside a building from a final exit which may be required for persons to reach a place of safety.

Evacuation lift: a passenger lift, protected in such a manner that it may be used for the evacuation of people requiring assistance.

External Escape Route: See Escape Route.

External Wall: an outer wall of a building (which is not a separating wall), taken from the innermost surface to outermost external surface, including all building components integral to the construction of the wall.

A part of a roof pitched at an angle of 70° or more to the horizontal may also be considered an external wall if that part of the roof adjoins a space within the building to which persons have access (but not access only for repair or maintenance of the building, or of the fixed building plant or infrastructure).

Final exit: the termination of an escape route from a building giving direct access to a street, passageway, walkway or open space, and sited to ensure the rapid dispersal of persons from the vicinity of a building so that they are no longer in danger from fire and/or smoke.

Fire door: a door or shutter, provided for the passage of persons, air or objects, which together with its frame and furniture as installed in a building is intended when closed to resist the passage of fire and/or gaseous products of combustion, and is capable of meeting specified performance criteria to those ends (It may have one or more leaves and includes a cover or other form of protection to an opening in a fire-resisting wall or floor, or in a structure surrounding a protected shaft).

Firefighting lift: a lift designed to have additional protection, with controls that enable it to be used under the direct control of the fire brigade in fighting a fire.

Firefighting lobby: a protected lobby that provides access from a firefighting stairway to the accommodation area and the firefighting lift.

Firefighting shaft: a protected shaft containing a firefighting stairway, a firefighting lobby with an internal fire main, and a firefighting lift.

Firefighting stairway: a protected stairway communicating with the accommodation area only through a firefighting lobby.

Section 0: Use of the Guidance

Fire Break: a material that achieves a reaction-to-fire classification of A2-s3, d2, or better, when classified to I.S. EN 13501-1, which interrupts the passage of fire between combustible elements or materials, e.g. used as parts of an external cladding or ETICS system.

Fire mains: pipes installed in and around buildings and equipped so that the fire service may connect hoses to receive a supply of water for firefighting.

Fire and rescue service access level: a level at which there is suitable entry to a building and to a firefighting shaft, where provided, from an area to which fire and rescue service appliances have access.

Fire-protecting suspended ceiling: a ceiling suspended below a floor, which contributes to the fire resistance of the floor (see [Diagram 42\(a\)](#)). (For different types, see [Appendix A, Table 33.](#))

Fire resistance: ability of an item to fulfil for a stated period of time the required fire stability and/or integrity and/or thermal insulation, and/or other expected duty specified under [Appendix A.](#)

Fire Stop: a seal provided to close an imperfection of fit or design tolerance between elements or components, to restrict or prevent the passage of fire and smoke.

Flat (apartment): a separate and self-contained premises constructed or adapted for residential use and forming part of a building from some other part of which it is divided horizontally.

Floor area: In relation to a building, “floor area” means the area bounded by the inner finished surfaces of the enclosing walls, or, on any side where there is no enclosing wall, by the outermost edge of the floor on that side and in calculating the area of a building or part of a building, there shall be included in such area the space occupied by any walls, shafts, ducts or structure within the area being measured (see [Diagram 87](#) of Appendix C).

Fly gallery: a narrow balcony or gantry, usually running from front to back of a stage on one or both sides and occasionally continuing across the back wall, that is used for securing suspension lines, loading counterweights and operating suspension lines, and occasionally for rigging lighting equipment.

Foyer: An open area inside a public building, where people can wait and meet each other, or access audience and spectator facilities.

Free Vent Area: The geometric open area of a ventilator.

Gallery: a floor or storey which consists of a raised area or platform which projects into the space of the room providing extra floor area.

Habitable room: a room used for living or sleeping purposes, but not a kitchen having a floor area less than 6.5 m², a bathroom, a toilet, or a shower room.

Hydrant: an assembly comprising a valve and outlet connection from an external fire main, provided to deliver a supply of water for firefighting.

Section 0: Use of the Guidance

Height (of an atrium): the level of the surface of the highest point of the floor of the highest storey adjacent to the atrium measured from the level of the atrium base (see [Diagram 93](#), Appendix C).

Height of a building: (or of part of a building which is completely separated throughout, both below and above ground, by a compartment wall or compartment walls in the same continuous vertical plane) means the height of such building or part measured from the mean level of the ground adjoining the outside of the external wall of the building to the level of half the vertical height of the roof of the building or part, or to the top of the walls or of the parapet (if any), whichever is the higher (see [Diagram 90](#) of Appendix C).

Height of the Topmost Storey: means the height of such building or part measured from the ground level on the lowest side of the building to the upper level of the topmost floor with habitable rooms, or in the case of a building with a rooftop amenity which can be accessed and used by occupants of the building in its normal use, to the upper surface of the rooftop level or part which can be accessed. Such a rooftop does not include rooftop plant which is accessed for maintenance purposes only (see [Diagram 91](#)).

Inner room: a room from which escape is possible only by passing through an access room.

Main kitchen cooking appliance: a cooking apparatus with a fixed connection to the dwelling's gas or electric energy infrastructure (for example, an oven and/or hob).

Maisonette: a flat forming part of a larger building, which has its rooms divided between two or more levels which are more than half a storey in height.

Mall: an access route for pedestrians in a shopping centre.

Mall exit: a final exit from a mall, or a storey exit, or an exit from a mall which leads directly to a storey exit or final exit by way of a protected corridor/passageway.

Mall section: the length of mall between two mall exits.

Material achieving A1: A1 products, classified to I.S. EN 13501-1. Such products will not contribute in to fire growth at any stage of the fire including the fully developed fire. For that reason, they are assumed to be capable of satisfying automatically all requirements of all lower classes.

Material achieving A2: A2 products, classified to I.S. EN 13501-1. Under conditions of a fully developed fire these products will not significantly contribute to the fire load and fire growth.

Means of escape: physical means whereby a safe route or routes is or are provided for persons to travel from any point in a building to a place of safety.

Measurement: (floor area, cubic capacity, height of a building, height of an atrium, atrium base, and number of storeys) - see Appendix C, [Diagram 87 to 93](#).

Section 0: Use of the Guidance

Non-open sided car park. A car park that does not satisfy the criteria for an open sided car park.

Notional boundary: a boundary presumed to exist between buildings on the same site (see [Diagram 65](#)).

Open-Plan flat: a flat with no protected entrance hallway.

Open-sided car park: A car park which complies with the following:

- (a) There should not be any basement storeys.
- (b) Each storey should be capable of being naturally ventilated by permanent openings at each level having an aggregate area not less than 5% of the floor area at that level, of which at least half should be in two opposing walls.
- (c) If the building is also used for any other purpose, the part forming the car park is a separated part (see Appendix C, [Diagram 89](#)).

Open spatial planning: the internal arrangement of a building in which more than one storey or level is contained in one undivided volume, e.g. split-level floors and balconies or gallery floors overlooking an unenclosed atrium (but not atrium galleries used only for circulation).

Open Stage: A stage where the proscenium wall (and associated fire curtain) is not provided.

Perimeter (of buildings): the maximum aggregate plan perimeter, formed by vertical projection onto a horizontal plane but excluding any parts which are connected to adjoining buildings (see [Diagram 72](#)).

Pipe: Is a pipe installed for the movement of water or other liquids, or gasses through a building including a soil vent pipe, pipe fittings and accessories, but does not include a flue pipe or a pipe provided for ventilation purposes.

Place of relative safety: location of comparative safety which includes any place that puts an effective barrier between the person escaping and a fire.

Place of safety: a place, normally in the open air at ground level, in which persons are in no danger from fire.

Place of special fire risk: area which due to its function may present a greater risk of fire occurring and developing than elsewhere, such as a transformer and switchgear room, a large commercial kitchen, a boiler room, a storage space for fuel or other highly flammable substance, a room housing a fixed internal combustion engine, or an area where flammable vapours are likely to be present in the atmosphere.

Pressurisation: a method of protecting escape routes against the ingress of smoke by maintaining an air pressure difference between the route and adjoining accommodation.

Proscenium wall: A wall with an arch, located at or near to the front of a stage, separating the stage from the auditorium

Section 0: Use of the Guidance

Protected corridor/lobby: a corridor or lobby which is adequately protected by fire-resisting construction from fire in adjoining accommodation.

Protected entrance hallway: A circulation area within a flat or maisonette compartment consisting of a hallway and/or or landing space enclosed with fire resisting construction (other than any part which is an external wall of the building).

Protected shaft: a shaft which enables persons, air or objects to pass from one compartment to another and is enclosed with fire-resisting construction.

Protected stairway: a stairway which is adequately protected by fire-resisting construction from fire in the accommodation through which it passes, and that discharges through a final exit to a place of safety.

Radial gangway: a gangway at an angle to the rows of seating or a stepped gangway in tiered seating.

Raised Access Floor: a raised floor supported by a structural floor, but with an intervening concealed space which is intended to house services.

Refuge: an area within a building separated by fire-resisting construction and provided with a safe route to a storey exit, where people who cannot self-evacuate can await assistance for their evacuation.

Relevant boundary: the boundary that the side of the building faces (see [Diagram 65](#)). A notional boundary can be a relevant boundary.

Rooflight: any dome light, lantern light, skylight or other element intended to admit daylight through a roof.

Room: an enclosed space in a building that is not an enclosed circulation space (The term therefore includes not only conventional rooms but also cupboards that are not fittings, and large spaces such as warehouses and auditoria).

Seatway: the distance between adjacent rows of fixed seats in a tiered seating arrangement.

Separated Part: a form of compartmentation that is a part which is separated from another part of the same building by a compartment wall which runs full height of the part and is in one plane (see Appendix C, [Diagram 89](#)).

Separated Stage: A stage design where the stage areas are separated from the audience areas by a proscenium wall and a safety curtain.

Separating wall: a compartment wall used to separate one building from another; such a compartment wall is the full height of the building and is in a continuous vertical plane.

Shopping centre: a structural combination of a number of commercial premises that includes areas providing common access for the public, principally for shopping purposes.

Section 0: Use of the Guidance

Single-storey building: a building consisting of a ground storey or a basement storey only (see Appendix C, [Diagram 89](#) for number of storeys in a building or separated part).

Smoke clearance system: a smoke control system designed to remove the products of combustion following a fire and used at the discretion of the fire service to assist firefighting operations.

Smoke control: any technique used to control the movement of smoky gases within a building in order to protect the structure, to protect the means of escape or to assist firefighting operations.

Smoke control zone: the subdivision of a building into areas for smoke control purposes, where required, which may consist of one or many smoke reservoirs.

Smoke control zone – Shopping Centre: The subdivision of a shopping centre building into areas for smoke control purposes which may consist of:

- (a) all or part of a unit; or
- (b) all or part of a mall, together with those units (or parts of units) from which smoke may flow into a mall.

Smoke reservoir: a volume of space provided within a building for the collection of smoke.

Storey: any of the parts into which a building is divided horizontally above or below ground level, but excluding any part of a building — situated above the level of the roof or in the roof space, or below the level of the lowest floor — which is intended for the protection of a water tank, or lift motor room, or similar use and is not intended for, or adapted to be used for habitable purposes, or as a work room, or as a store room.

A gallery should be considered a storey where:

- (a) it is in an assembly and recreation building; or
- (b) if its area exceeds half of the space into which it projects, in any other building.

Storey exit: a final exit or a doorway opening into a protected stairway, firefighting lobby or external escape route.

Structural element: An element of the structure of a building which is one of the following:

- (a) a member forming part of the structural frame of a building; or
- (b) a load-bearing wall or load-bearing part of a wall; or
- (c) a floor; or
- (d) a gallery; or
- (e) an external wall; or
- (f) a compartment wall (including a separating wall).

Student accommodation unit: a separate and self-contained unit constructed or adapted for residential use, for the exclusive use by students, forming part of a building from some other part of which it is divided horizontally.

Section 0: Use of the Guidance

Thermoplastic material: any polymeric material which has a softening point below 200°C if tested to I.S. EN ISO 306. Specimens for this test may be fabricated from the original polymer where the thickness of material of the end product is less than 2.5mm.

Transverse gangway: a flat gangway parallel to rows of tiered seating.

Travel distance: the actual distance to be travelled by a person from any point within the floor area to the nearest storey exit, having regard to the layout of walls, partitions and fittings.

Uncovered shopping centre: a shopping centre that does not include a covered mall.

Undefined Escape Route: See Escape Routes.

Unit: premises in individual occupancy which forms part of a shopping centre; the term “unit” applies to any shop or other use served by a mall or walkway.

Unit exit: the termination of an escape route from within a unit in a shopping centre. This may be a point at which persons enter a common area.

Unprotected area: In relation to a side or external wall of a building, the following are considered to be unprotected:

- (a) a window, door or other opening (excluding openings with the relevant fire resistance); or
- (b) any part of the external wall which has less than the relevant fire resistance set out in [Subsection 4.4](#); or
- (c) any part of the external wall which has a material that does not achieve a reaction to fire classification of Class A – s3, d2, more than 1 mm thick attached or applied to its external face, whether for cladding or any other purpose.

Width of a doorway: is the effective clear width when the door or doors are open (see [Diagram 1 \(Para 1.3.2\)](#)).

Working fly gallery: a fly gallery, usually the lowest if more than one gallery is provided, which is likely to be occupied during performances in theatres, or similar premises, by staff operating suspension lines.

Works: any act or operation in connection with the construction, extension, alteration, repair or renewal of a building.

Section 1: Means of Warning and Escape in Case of Fire

Section 1 Means of Warning and Escape in Case of Fire

1.1 Introduction to Provisions

The guidance in this section shows how to achieve compliance with Part B of the Second Schedule to the Building Regulations, in particular Regulation B1. However, the provisions outlined in Section 2 (Internal Fire Spread (Linings)), Section 3 (Internal Fire Spread (Structure)), and Section 6 (Smoke Control Systems) are relevant in achieving compliance with Regulation B1. Compliance with Section 1 also aids in achieving adequate provision for firefighting, outlined in Section 5 (Access and Facilities for the Fire Service).

These requirements may be achieved:

- (a) if the design and provision of an alarm system is such that the occupants are given adequate warning of the existence of fire; and
- (b) if there are routes of sufficient number and size, which are suitably located, to enable persons to escape to a place of safety in the event of fire; and
- (c) if the routes are sufficiently protected from the effects of fire in terms of enclosure, where necessary, and in the use of materials on the routes; and
- (d) if sufficient systems are provided to enable the occupants to use the routes safely

all to an extent necessary that is dependent on the use of the building, its size and height.

1.1.1 General

The provisions in this section are concerned with the measures necessary to ensure reasonable facilities for means of escape in case of fire, and with structural fire precautions only where these are necessary to safeguard escape routes. The provisions assume that the occupants of buildings will include people with disabilities and that, in the design of the building, reliance should not be placed on external rescue by the fire service.

The document, therefore, has been prepared on the basis that the occupants of any part of a building should be able to escape safely from a fire to a place of relative safety either outside the building or inside the building, to a place which has been adequately designed to function as a place of relative safety in an emergency and without external assistance.

1.1.2 Analysis of the Problem

The design of means of escape from a building must be based on an appreciation of the probable behaviour of fire, which may break out in any part of the building and then spread to other parts.

Fires do not normally start in two different places in a building at the same time, and initially a fire will create a hazard only in the part in which it starts and is unlikely at this stage to involve a large area. Subsequently, it may spread to other parts, usually along the circulation routes of the building.

Section 1: Means of Warning and Escape in Case of Fire

Fires do not normally originate in the structure of the building itself or in circulation areas, such as passages, corridors, lobbies or stairways. Therefore, protected escape routes are designed to provide virtually fire sterile areas.

The primary danger associated with fire in its early stages is not flame but the smoke and noxious gases produced by the fire. Most of the casualties in fires have been caused by smoke, which has often also obscured the way to escape routes and exits. Measures designed to provide safe means of escape must therefore include provisions to limit the spread of smoke and toxic gases (see [Section 3](#), and [Section 6](#)).

1.1.3 Criteria for Means of Escape

Generally, people should be able to turn their backs on a fire wherever it occurs and travel away from a fire to a protected escape route leading to a place of safety.

When account is taken, however, of the way a building is to be used, there are many circumstances in which it is not reasonably possible to provide alternative means of escape from all parts of the floor or building. In limited conditions, a dead end can be accepted as providing reasonable safety.

These conditions depend on the use of the building and its inherent fire risk, the size and height of the building, and the numbers of persons accommodated within the dead end.

The basic principles for the design of means of escape are as follows:

- (a) There should be a minimum of two means of escape, however, in limited circumstances, a single means of escape, as set out in this document, is appropriate.
- (b) Where direct escape to a place of safety is not possible, the means of escape should consist of two parts
 - (i) an unprotected escape route which should be limited in extent and should lead to a protected escape route; and
 - (ii) a protected escape route which should lead to a place of safety.

The ultimate place of safety is, of course, the open air, clear of the effects of the fire.

Where an escape route from a building leads to an enclosed space (e.g. an enclosed yard), such an enclosed space should be provided with adequate means of egress to an unenclosed space (e.g. a public way). In many buildings, however, reasonable safety may be reached within the building, provided adequate design and protection measures are incorporated in accordance with the guidance given in this document.

Section 1: Means of Warning and Escape in Case of Fire

1.1.3.1 Unacceptable escape routes

The primary vertical means of escape in buildings is via a protected stairway. The following are not acceptable as a means of escape:

- (a) a lift (except a lift which is suitably designed, and installed for the purpose of evacuation (see [Para 1.9.9.8](#))); or
- (b) A mechanised walkway, escalators or throw-out ladders; or
- (c) manipulative apparatus & appliances, e.g. fold-down ladders and chutes.

While in the static mode, mechanised walkways may be accepted as a means of escape and their capacity assessed on the basis of their use as a walking route.

1.1.4 Unprotected and Protected Escape Routes

The unprotected part of an escape route is that part which a person has to traverse before reaching either the safety of a final exit or the comparative safety of a protected escape route.

A protected escape route is that part of an escape route which is protected from the effects of fire by fire-resisting construction leading either to a final exit or a storey exit. Protected escape routes include protected corridors, protected lobbies and protected stairways.

Protected stairways are designed to provide virtually "fire sterile" areas which lead to places of safety outside the building. Once inside a protected stairway, a person can be considered to be in a place of relative safety.

1.1.5 Progressive Horizontal Escape in Residential (Care Facility) Buildings (Purpose Group 2(a))

In areas designed for patients in residential (care facility) buildings, the principle of total evacuation of a building in the event of a fire may be initially inappropriate.

It is therefore appropriate to adopt the principal of progressive, staged evacuation of occupants from an area in which fire occurs to an adjoining area (or areas) on the same level which affords sufficient protection from the fire and smoke. This enables these occupants (and the occupants of the adjoining area) to remain safe until the fire has been dealt with.

Progressive horizontal escape should always be planned to ensure that, if further stages of evacuation become necessary, ultimately a protected vertical escape route is reached. A whole floor would be evacuated by means of a stairway (or a suitably protected bed/evacuation lift) only as a last resort if the fire could not be brought under control.

Provisions relating to progressive horizontal evacuation are contained under [Para 1.4.5](#).

1.1.6 Security Measures

Security measures should not contravene provisions for adequate means of escape in the event of fire.

1.2 Use of This Document for the Design of Means of Escape

Guidance on means of escape for the purpose groups listed in [Table 1](#) are contained in Subsections 1.4 -1.9, excluding the specific buildings outlined in [Para 1.2.1](#) and [Para 1.2.2](#).

- [Subsection 1.4: Design for Horizontal Escape](#)
- [Subsection 1.5: Design for Vertical Escape](#)
- [Subsection 1.6: Means of Escape from Flats](#)
- [Subsection 1.7: Means of Escape from Shopping Centres](#)
- [Subsection 1.8: Small Premises](#)
- [Subsection 1.9: General Provisions for Means of Escape](#)

Subsections 1.4 to 1.8 as appropriate should be read in conjunction with [Subsection 1.9](#).

Where another use forms part of a building (other than where ancillary), the appropriate guidance relevant to its use should be used (see [Subsection 0.5](#)).

Where different uses form part of a shopping centre, further recommendations for these situations are contained in [Subsection 1.7](#).

In the case of shop or office, with no storey larger than 280 m² and having no more than 2 storeys plus a basement storey, the guidance in [Subsection 1.8](#) may be followed instead of the provisions of [Subsection 1.4](#) and [Subsection 1.5](#).

1.2.1 Hospitals

Guidance on the provision of means of escape in Hospitals (Purpose Group 2(a)(i)) is provided in:

- (a) Chapter 3 and Chapter 5 of Health Technical Memorandum (HTM) 05-02, and
- (b) [Subsection 1.9](#) (General Provisions for Means of Escape) of this Technical Guidance Document.

Hospitals, in particular, require that evacuation procedures be given special consideration in the design of the means of escape. The principle of progressive horizontal evacuation is particularly relevant.

Guidance on all other aspects of compliance with Part B, including compartmentation, is contained in Sections 2 - 7 of this document. Where sprinklers are used, any provision set out in HTM 05-02 which diminishes a requirement given in this Technical Guidance Document are not appropriate.

Section 1: Means of Warning and Escape in Case of Fire

1.2.2 Stadiums, Grandstands or Other Outdoor Spectator Accommodation

The design of outdoor spectator accommodation, e.g. sports pavilions, stadiums, grandstands or other forms of spectator accommodation is outside the scope of this document.

Guidance on the adequate design of such accommodation is contained in:

- *Code of Practice for Safety at Sports Grounds* (Department of Education); or
- *The Guide to Safety at Sports Grounds*, also known as the “Green Guide” (Department for Culture, Media and Sport, U.K.).

However, where internal accommodation is provided, or the means of escape from the viewing area passes into the building, the relevant guidance outlined at Subsections 1.3 to 1.9 should be used. Care should be taken in the design of the capacity of escape routes within the building, where spectators use internal escape routes.

1.3 Methods of Measurement

1.3.1 Capacity Calculation Method

Occupant capacity is used to determine the minimum widths required to facilitate effective occupant evacuation. The following method of calculation applies:

- (a) Occupant capacity of a room or storey is the maximum number of persons it is designed to hold when calculated (using the occupancy load factors given in [Table 2](#)) from:

$$\frac{\text{Area of room or storey (m}^2\text{)}}{\text{Occupancy load factor}}$$

(For calculation purposes, the “area” excludes stairway enclosures, lifts, sanitary accommodation and rooms used solely for the purpose of plant and maintenance.)

- (b) Occupant capacity of a building or part of a building is the sum of the number of occupants of the storeys in the building or part. This number is derived from the calculated number of occupants per floor or part using the method at (a) above.

When a room is used for more than one purpose, the numerically lower or lowest occupant load factor should be used in calculation, i.e. the most onerous requirement should apply.

1.3.2 Measurement of Width

The width of doors, escape routes and stairways should be measured as follows:

- (a) A doorway is the clear width when the door or doors are open. Door hardware must be considered when measuring the width of a door opening (see [Diagram 1](#)). For doors on escape routes, see [Para 1.9.3](#).
- (b) An escape route is the width measured at 1.5 m above floor level when defined by walls (Handrails fixed to walls which do not intrude more than 100 mm into this width may be ignored) or elsewhere the minimum width of passage available between any fixed obstructions.
- (c) A stairway is the clear width between the walls or balustrades. (Strings and handrails intruding not more than 30 mm and 100 mm, respectively, may be ignored.)

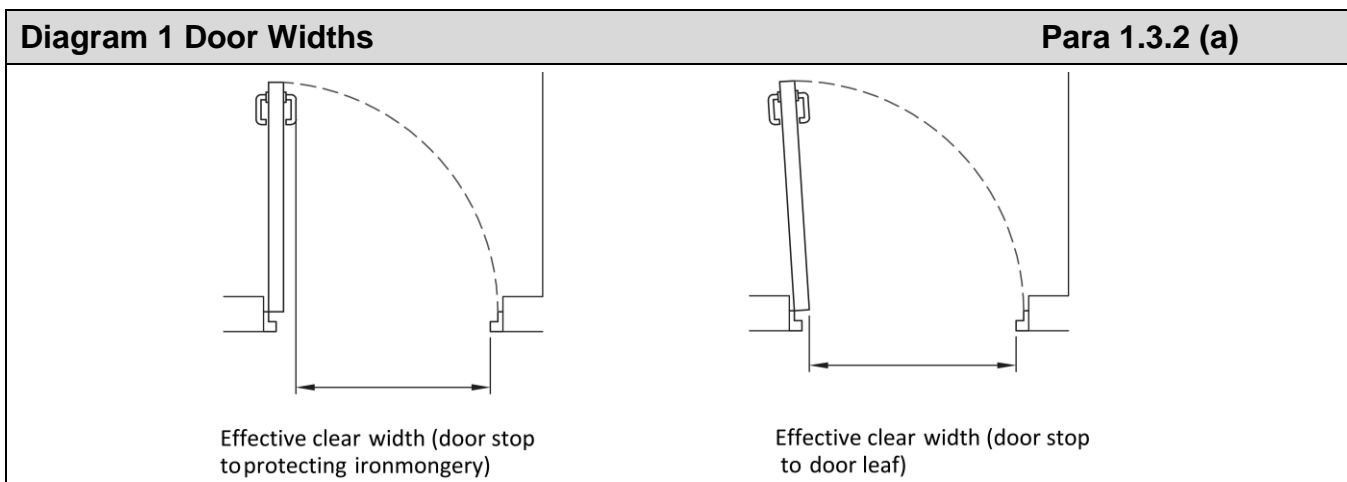

Table 2 Occupancy Load Factor		Para 1.3.1
Accommodation ⁽¹⁾		Occupancy Load Factor
1.	Standing area in assembly and recreation building.	0.3
2.	Assembly / dual-purpose area in a school.	0.45
3.	Bar, lounge bar, amusement arcade, dance area.	0.5
4.	Restaurant, dining room, meeting room, committee room, staff room.	1.0
5.	Ice rink, skating rink.	1.2
6.	Studio (film, radio, TV, recording).	1.4
7.	Exhibition area.	1.5 ⁽²⁾
8.	Classroom or room in a day centre.	2.0 ⁽³⁾
9.	Shop, reception area.	4.0
10.	Factory production area, open-plan offices, museum/art gallery, sports hall, gymnasium.	5.0
11.	Other office, library, kitchen.	7.0
12.	Bedroom or study bedroom.	8.0 ⁽⁴⁾⁽⁵⁾
13.	Billiards/snooker room, bowling alley.	10
14.	Warehouse, storage building, car park.	30.0 ⁽⁶⁾
15.	Auditoria, lecture room, room or area with tiered seating.	Number of seats
16.	Continuous bench seating.	400 mm per person

Notes:

(1) Includes categories appropriate to those purpose groups and building types other than those covered by documents outlined in Para's 1.2.1 and 1.2.2. Where accommodation is not directly covered by the descriptions given, the most appropriate value, from this table, having regard to the building's use should be applied.

(2) Alternatively, a factor 0.4 m² may be used over the gross area of gangways or other clear circulation areas between stalls and stands.

(3) Alternatively, the number of seats or design capacity of the classroom.

(4) Alternatively, the number of bed spaces provided.

(5) Includes a bedroom in a flat

(6) Alternatively, 2 persons per car space.

1.4 Design for Horizontal Escape

1.4.1 Introduction

The general principle to be followed when designing facilities for means of escape is that any person confronted by an outbreak of fire within a building can turn away from it and make a safe escape.

This subsection deals with the provision of means of escape from any point to the storey exit of the floor in question.

This subsection should be read in conjunction with the general provisions for means of escape set out in [Subsection 1.9](#).

1.4.2 Number of Escape Routes and Exits

The number of escape routes and exits to be provided from a room or storey depends on the following factors:

- (a) the number of occupants (see [Para 1.4.2.1](#));
- (b) the limitations on travel distance (see [Para 1.4.2.2](#) and [Table 3](#)); and
- (c) the minimum number of escape routes required (see [Para 1.4.2.4](#) and [Table 4](#)).

1.4.2.1 Number of Occupants

The number of occupants likely to use a room or storey is determined by the occupant capacity calculation.

Guidance on calculating occupant capacity is set out in [Subsection 1.3](#) of this document and in [Table 2](#).

The number of occupants in a room or storey will determine the width of escape routes and the number and width of exits to be provided (see [Para 1.4.3.1](#)).

1.4.2.2 Travel Distance

The travel distance from any point in a room or storey to the nearest storey or final exit should not exceed the appropriate values indicated in [Table 3](#) (see [Diagram 2](#)). The permitted travel distance will depend on whether escape is available in one direction only or in more than one direction.

Escape is available in more than one direction where alternative escape routes (see [Para 1.4.2.3](#)) are provided.

Travel distance is measured by way of the shortest route, which if:

- (a) there is fixed seating or other fixed obstructions, is along the centre line of the seatways and gangways; and
- (b) it includes a stairway, is along the pitch line on the centre-line of travel.

Section 1: Means of Warning and Escape in Case of Fire

In many cases, the beginning of the escape route will be in one direction only (i.e. a single escape route) to a point where there are alternative escape routes.

This is acceptable provided that the total travel distance to the nearest exit is within the limits for routes where escape is possible in more than one direction and the section with the single escape route does not exceed the limit for escape in one direction only (see [Table 3](#) and [Diagram 3\(c\)](#)).

1.4.2.2.1 Direct Distance

Where the internal arrangement of walls and fixed furniture is not known, direct distance should be used for assessment. For design purposes, the direct distance may be taken as $\frac{2}{3}$ of the travel distance. However, the final layout should not create travel distances which exceed the tabulated values given in [Table 3](#).

1.4.2.2.2 Storey Exits in Industrial, Storage and Office Buildings

Escape routes in office, industrial and storage buildings should, generally lead to a storey or final exit (see [0.10 Definitions](#)). In limited cases, escape routes may lead to an adjoining compartment provided that:

- (a) The building is in one occupancy; and
- (b) The adjoining compartment is separated from the fire affected area by compartment walls with the openings therein fitted with self-closing fire doors; and
- (c) The adjoining compartment is of sufficient size to accommodate both its own occupants and those exiting to it from the fire affected area; and
- (d) The adjoining compartment has storey or final exits (see [0.10 Definitions](#)) of sufficient capacity to cater for its own occupants, and any occupants of the adjoining compartment, which expected to escape into it, based on the aggregate widths of doors in the compartment.

1.4.2.3 Alternative Escape Routes

Where there is more than one exit from a room, the exits should be suitably located in relation to each other such that they would not be made unavailable for escape, simultaneously, by fire.

Every escape route from a storey should be independent of any other escape route to which access may be obtained directly from that storey.

Alternative escape routes should satisfy the following criteria:

- (a) They are in directions 45° or more apart (see [Diagram 3\(a\)](#)); or
- (b) They are in directions less than 45° apart, but are separated from each other by fire-resisting construction ([Diagram 3\(b\)](#)); or

Section 1: Means of Warning and Escape in Case of Fire

- (c) Where there is a limited distance of travel in a single direction, before the option of an alternate number of routes becomes available, the angle of separation of alternate escape route options should be not less than 45° plus 2.5° per metre travel in one direction ([Diagram 3\(c\)](#)). The total travel distance to the nearest exit should be within the limits for routes where escape is possible in more than one direction and the section with the single escape route should not exceed the limit for escape in one direction only (see [Table 3](#) and [Diagram 3\(c\)](#)).

Diagram 2 Measurement of Travel Distance

Para 1.4.2.2

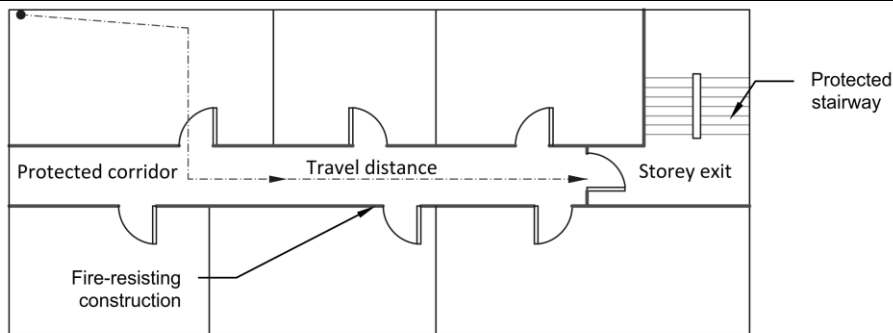

(a) Escape in one direction only (corridor)

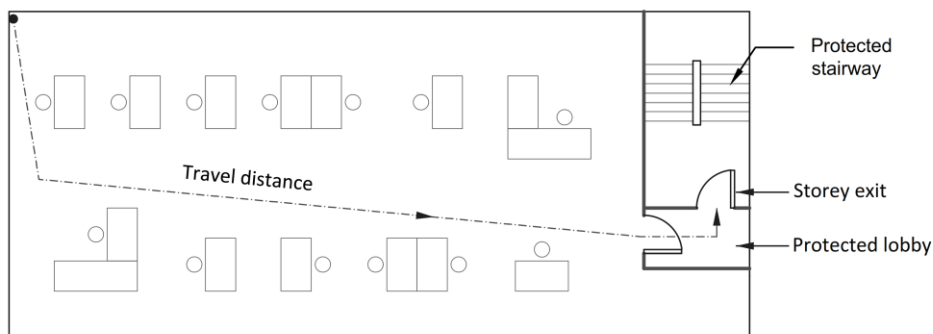

(b) Escape in one direction only (open plan)

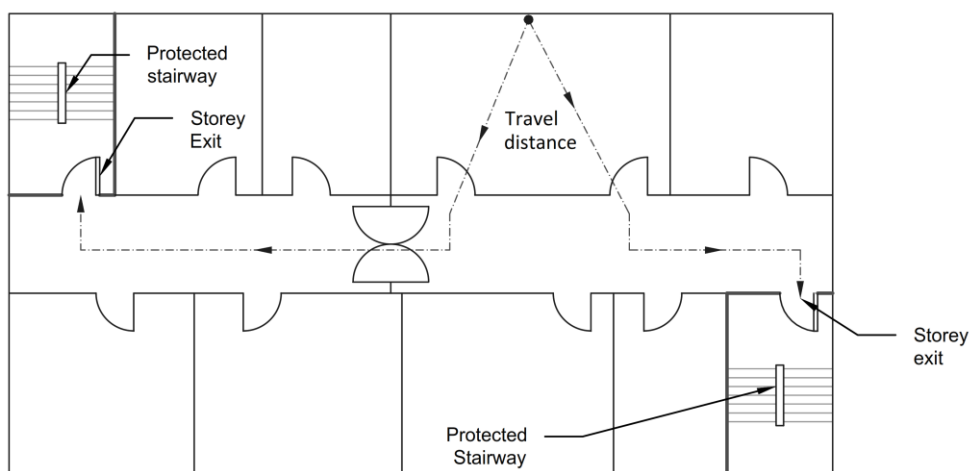

(c) Escape in more than one direction

Notes:

- (1) For provision of fire-resisting construction, see Appendix A
- (2) For provision of fire doors, see Appendix B
- (3) Where the distance between storey exits exceeds 12 m, self-closing fire doors are required.
- (4) See also [Diagram 9](#) for fire-resisting subdivision of a storey

Table 3 Limitations on Travel Distances		Para 1.4.2.2	
Purpose Group(s) (1)(2)	Use of premises or part of premises	Maximum travel distance ⁽³⁾ related to available direction of escape	
		In one direction	In more than one direction
1(c)	Roof top areas, for the exclusive use of residents	18	45
2(a)	Residential (care facility)	10	20
2(b)	Other residential:		
	(a) bedroom ⁽⁴⁾	10	20
	(b) bedroom corridor	10	35
	(c) elsewhere	20	35
3, 4(a) ⁽⁵⁾	Offices, Shop		45
4(b)	Shopping centre		
	(a) Covered mall	9	45
	(b) Enclosed uncovered mall		
	Ground level	25	Unlimited
	Any other level	9	45
5(a)	Assembly and recreation		
	(a) Buildings primarily for use by persons with disabilities	9	18
	(b) Areas with seating in rows	15	32
	(c) Other areas	18	45
5(b)	Day centre		
	(a) Buildings primarily for use by persons with disabilities	9	18
	(b) Used as a crèche, preschool or day nursery	10	20
	(c) Any other day centre	18	45
6(a)	Industrial Normal Hazard ⁽⁶⁾	25	45
6(b)	Industrial High Hazard ⁽⁶⁾	12	25
7 (a)	Storage Normal Hazard ⁽⁶⁾	18	45
7(b)	Storage High Hazard ⁽⁶⁾	15	32
7 (c)	Car parks	18	45
8	Other non-residential	18	45
2 - 8	Place of special fire risk ⁽⁷⁾	9	18
2 - 8	Plant room or roof top plant		
	(a) within room	9	35
	(b) total travel dist. (not in the open air)	18	45
	(c) total travel dist. (in the open air)	60	100

Notes:

(1) Purpose Groups are defined in [Table 1](#) to [Section 0](#).

(2) This table does not apply to hospitals (see [Para 1.2.1](#)).

(3) Where the internal arrangement of walls and fixed furniture is not known, direct distance should be used for assessment (see [Para 1.4.2.2.1](#)).

(4) Denotes the maximum travel which is within a bedroom (or bedroom suite).

(5) See [Table 10](#) for travel distance in the case of small premises.

(6) See [Appendix D](#) for assessment of hazard in industrial and storage buildings.

(7) Places of special fire risk are defined in [Subsection 0.10](#).

Diagram 3 Alternative Escape Routes

Para 1.4.2.3

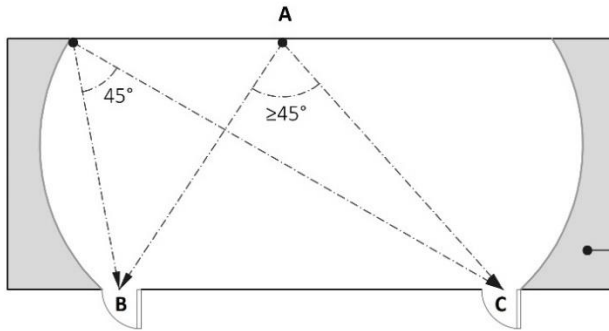

(a) In directions 45° or more apart

Two directions of escape assumed, if angle indicated is 45° or more.

In shaded areas where the angle will be less than 45° at any point, one direction of escape only should be assumed and dead end conditions will apply.

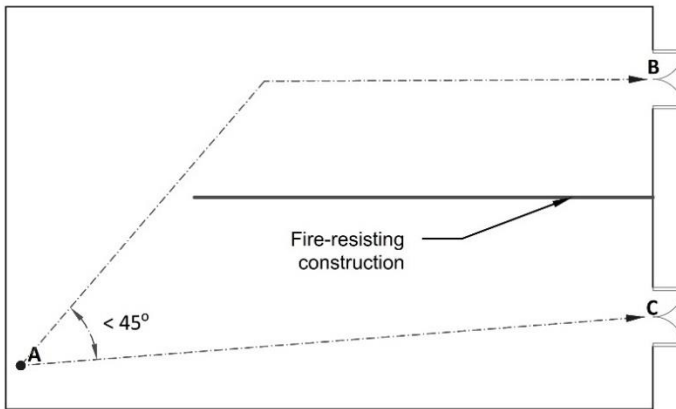

(b) In directions less than 45° apart, escape routes separated by fire resisting construction

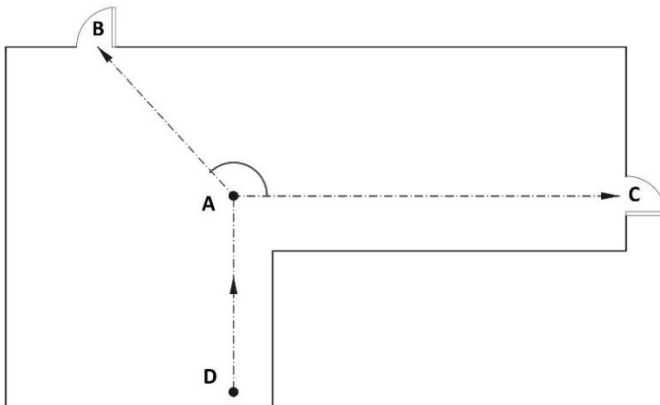

Angle BAC = $45^\circ + 2.5^\circ$ for every metre travelled from D to A.

Note: DA not to exceed that allowed for single direction of travel.

Single escape route exists at D.

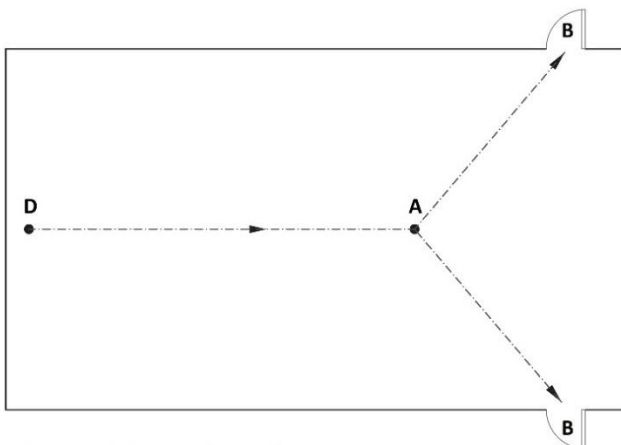

(c) Initial dead end condition

Section 1: Means of Warning and Escape in Case of Fire

1.4.2.4 Minimum Number of Escape Routes

The number of escape routes from any room or storey should be not less than that indicated in [Table 4](#), except where permitted by [Para 1.4.2.5](#) to be served by a single escape route.

Table 4 Minimum Number of Escape Routes		Para 1.4.2.4
Number of persons accommodated	Minimum number of escape routes	
1 to 500	2	
More than 500	3	

1.4.2.5 Single Escape Route

In order to avoid occupants being trapped by fire or smoke, there should be alternative escape routes from all parts of the building, except for the situations listed below, where a single route can be acceptable:

- (a) in the case of a residential (care facility) building, (Purpose Group 2(a)(ii)), areas, or rooms not likely to contain more than 20 persons provided that the limits on travel in one direction only are satisfied (see [Table 3](#)); or
- (b) in the case of a day centre building (Purpose Group 5(b)(i)), used as a crèche, pre-school or day nursery, areas, rooms or a storey not likely to contain more than 20 persons provided that the limits on travel in one direction only are satisfied (see [Table 3](#)); or
- (c) in the case of a school (Purpose Group 5(a) (ii)), areas, rooms or a storey, with direct access to a corridor, final exit, or lobby leading to a final exit, not likely to contain more than 60 persons, provided that the limits on travel in one direction only are satisfied (see [Table 3](#)); or
- (d) in the case of all other Purpose Groups, areas, rooms or a storey not likely to contain more than 60 persons provided that the limits on travel in one direction only are satisfied (see [Table 3](#)).

1.4.3 Planning of Escape Routes and Exits

The basic principle of escape-route planning is that unless a route is very short, there should be an alternative which will not be affected if fire or smoke makes the first route impassable.

Every escape route should lead to a place of safety, and should give direct access to that place of safety, or give access thereto only by means of a circulation area.

Section 1: Means of Warning and Escape In Case of Fire

1.4.3.1 Width of Escape Routes and Exits

The width of escape routes and exits depends on the number of persons needing to use them, should not be less than the dimensions given in [Table 5](#), and should not narrow in the direction of escape.

An escape route may become unavailable due to a fire in a building. It is therefore necessary to discount each escape route in turn and to take account of this when calculating the total capacity of available escape routes. Discounting of storey exits is not required where:

- (a) there is only a single escape route (see [Para 1.4.2.5](#)); or
- (b) all the exits from an area open directly to the open air at ground-floor level.

The total capacity of the escape routes and exits from any room or storey should be adequate for the number of occupants, taking account of discounting, where required. The total capacity should be based on the sum of the capacities of each individual escape route or exit, based on the values indicated in [Table 5](#), with an allowance for discounting where applicable.

Table 5 Width of Escape Routes and Exits	
Maximum number of persons	Minimum width (mm) ^{(1) (2) (3)}
60	800 ⁽⁴⁾
100	850
150	950
220	1050
More than 220	5mm per person ⁽⁵⁾

Notes:

- (1) Refer to [Para 1.3.2](#): Measurement of Width.
- (2) The minimum widths given in the table may need to be increased in accordance with the guidance in TGD M: Access and Use.
- (3) Widths less than 1050 mm should not be interpolated.
- (4) May be reduced to 530 mm for gangways between fixed storage racking other than in public areas of Industrial or Storage buildings (Purpose Group 6 or 7).
- (5) 5 mm per person does not apply to an opening serving less than 220 persons.

1.4.3.2 Assembly and Recreation Buildings (Purpose Group 5(a))

In assembly and recreation buildings (Purpose Group 5(a)), the escape route provided by the main entrance to the building should be capable of discharging at least one-third of the occupant capacity in accordance with the provisions of [Table 5](#).

Where an escape route or routes from one or more tiers in a theatre, cinema or similar venue discharge into a foyer, the foyer should be enclosed with fire-resisting construction (see [Table 31](#), Item 25).

Section 1: Means of Warning and Escape in Case of Fire

Where escape routes from different auditoria within a theatre, cinema or similar venue, e.g. from different cinemas within a multi-cinema complex, discharge into a common foyer, the foyer should be enclosed with fire-resisting construction (see [Table 31](#), Item 25), and protected lobbies should be provided between the foyer and the escape routes discharging therein. The foyer may be part of an escape route only if the other escape route(s) lead directly to a place of ultimate safety.

In certain buildings where there are closely seated audiences, special provisions, which include the width of seatways and gangways, apply (see [Para 1.4.7](#)).

1.4.3.3 Inner Rooms

A room whose only escape route is through another room is termed “an inner room”. Occupants within this inner room are at risk if a fire starts in the other room termed “an access room” (see [Diagram 4\(a\)](#)). Such an arrangement is only acceptable if all the following conditions are satisfied:

- (a) The inner room should not be likely to have more than 20 occupants; and
- (b) The inner room should not be a bedroom; and
- (c) The escape route from the inner room should not pass through more than one access room; and
- (d) The travel distance from any point in the inner room to the exit(s) from the access room should not exceed the appropriate limit given in [Table 3](#); and
- (e) The access room should not be a place of special fire risk, and it should be in the control of the same occupier; and
- (f) One of the following arrangements is made:
 - (i) The enclosures (walls or partitions) of the inner rooms are stopped at least 0.5m below the ceiling level; or
 - (ii) A vision panel is located in the enclosure of the inner room, of sufficient size, at appropriate height to enable any person in the inner room to obtain early visual warning of an outbreak of fire; or
 - (iii) The access room is fitted with a suitable fire detection and alarm system to warn the occupants of the inner room should an outbreak of fire occur in the access room.

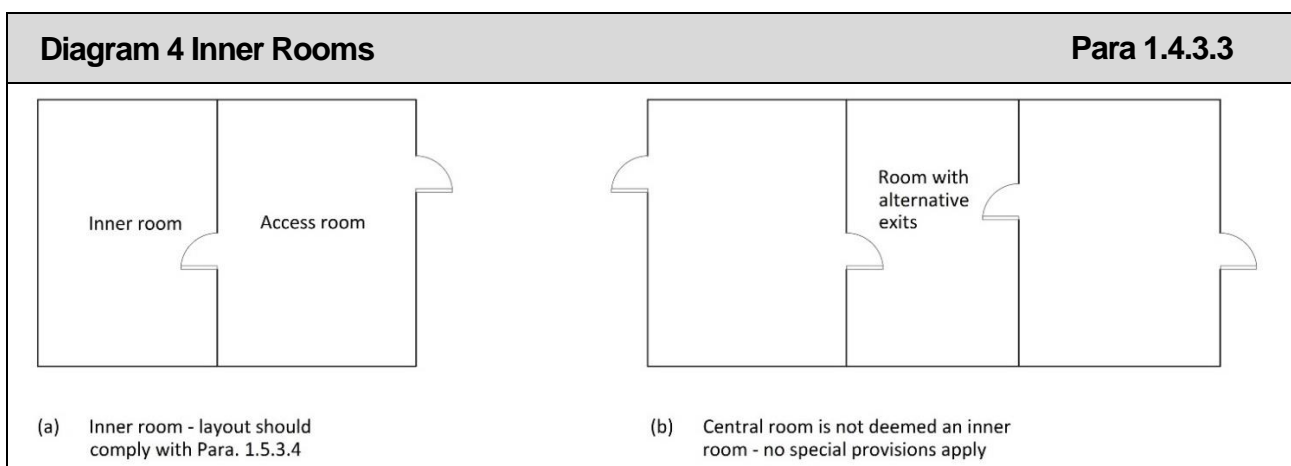

Section 1: Means of Warning and Escape In Case of Fire

1.4.3.4 Open Connections between Floors

Routes and exits should not be prejudiced by open connections between floors. Where travel is in one direction only, the escape route should not be within 5m of a void edge between floors unless it is leading away from the opening. Where there is a choice of routes, at least one of them should lead away from the opening (see [Diagram 5](#)).

Where the open connection is in a compartment floor (atrium), additional provisions may apply (see [Para 3.8.3](#)).

For shopping centres, see [Subsection 1.7](#).

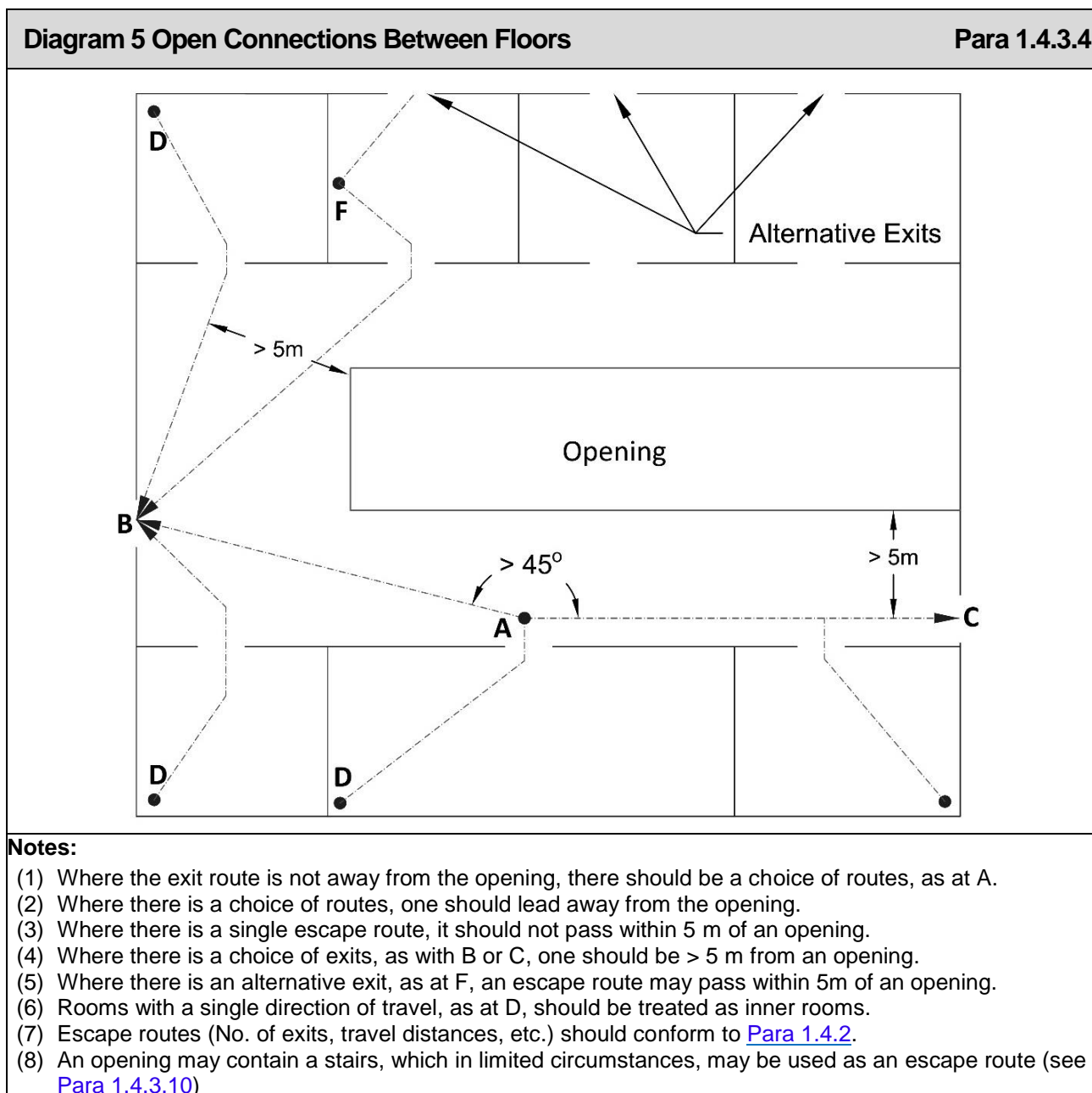

1.4.3.5 Planning of Exits in a Central Core

Buildings with more than one exit in a central core should be planned so that storey exits are remote from one another, and so that no two exits are approached from the same lift hall, common lobby or undivided corridor, or linked by any of these (see [Diagram 6](#)).

Section 1: Means of Warning and Escape in Case of Fire

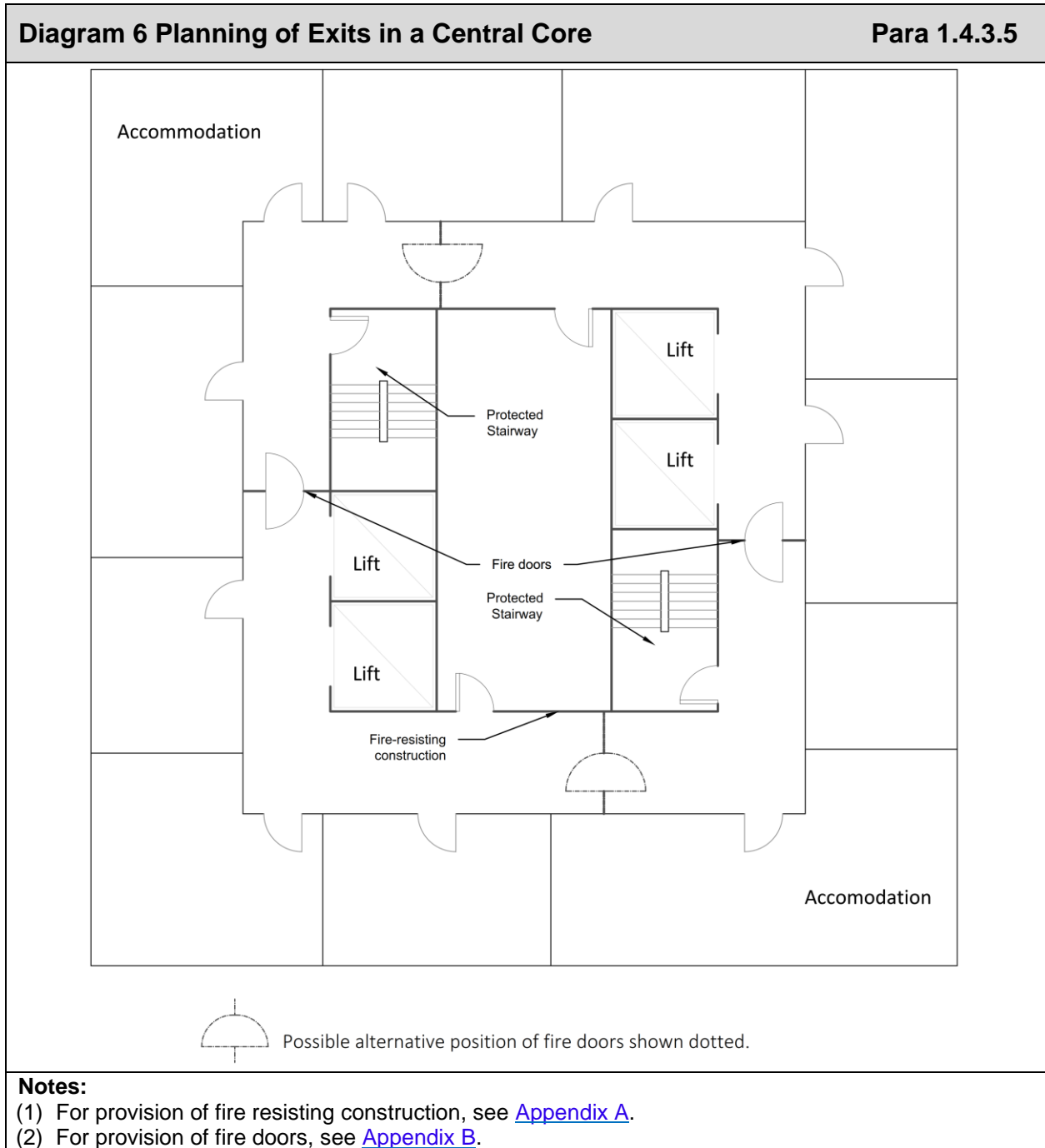

1.4.3.6 Access to Storey Exits

A storey which should have more than one escape stairway should be planned so that it is not necessary to pass through one stairway to reach another.

1.4.3.7 Separation of Circulation Routes from Stairways

An escape stairway should not form part of the primary circulation route between different parts of the building at the same level.

An exception to this requirement may be made in the case of a building, having not more than three storeys (see Appendix C, [Diagram 89](#)), which is served by a single escape stairway (see [Para 1.5.3](#)) where rooms open directly into the enclosure to the stairway and where self-closing fire doors are fitted with an electro-magnetic or electro-mechanical hold open device, to avoid their being rendered ineffective by misuse.

Section 1: Means of Warning and Escape In Case of Fire

1.4.3.8 Storeys Divided into Different Occupancies

Where any storey is divided into separate occupancies (i.e. where there are separate ownerships or tenancies of different organisations):

- (a) the means of escape from each occupancy should, in general, not pass through any other occupancy; and
- (b) the common corridor serving the different occupancies should be a protected corridor (see [Para 1.4.4.1](#)); and
- (c) a fire detection and alarm system should be provided (see [Para 1.9.13](#)).

1.4.3.9 Escape Routes in Shops

An escape route for the public from a retail area may be via an area of ancillary accommodation, other than an area of high fire hazard, provided that it is not the only available escape route from the area concerned. The route through the area of ancillary accommodation to a storey exit should be clearly defined by means of guard rails. For design with respect to handrails and guarding, see Technical Guidance Document K.

1.4.3.10 Escape from Galleries in Shops, Offices and Industrial Buildings

The means of escape from a gallery (see also [Para 1.5.6.2](#), [Para 3.3.5](#)) should conform to one of the following:

- (a) Where the gallery is only used for storage or access for servicing or maintenance of the building's fixed plant or infrastructure, and there is a single direction of escape from the gallery:
 - (i) The total travel distance from the deepest point on the gallery, to the nearest storey exit on the storey below the gallery, inclusive of any going on a stairs, should be in accordance with [Table 3](#); and
 - (ii) The stairs should discharge within 3 m of an exit; and
 - (iii) The stairs may be open.
- (b) Where the gallery is only used for storage or access for servicing or maintenance of the building's fixed plant or infrastructure, and there are a choice of exit routes from the gallery:
 - (i) The total travel distance from the deepest point on the gallery, to the nearest storey exit on the storey below the gallery, inclusive of any going on an open stairs, should be in accordance with [Table 3](#); and
 - (ii) The alternative escape routes should conform to [Para 1.4.2.3 \(a\)](#); and
 - (iii) Each stair may be open.
- (c) Where the gallery is regularly occupied or accessible to members of the public:
 - (i) At least two escape routes should be provided from the gallery; and
 - (ii) One of the escape routes should be via a protected stairway; and
 - (iii) Open stairs from the gallery should discharge within 3 m of a storey exit; and
 - (iv) The total travel distance from any point on the gallery to the nearest storey exit inclusive of any going on an open stairs should be in accordance with [Table 3](#).

Section 1: Means of Warning and Escape in Case of Fire

Diagram 7 Escape from Galleries in Shops, Offices and Industrial Buildings

Para 1.4.3.10

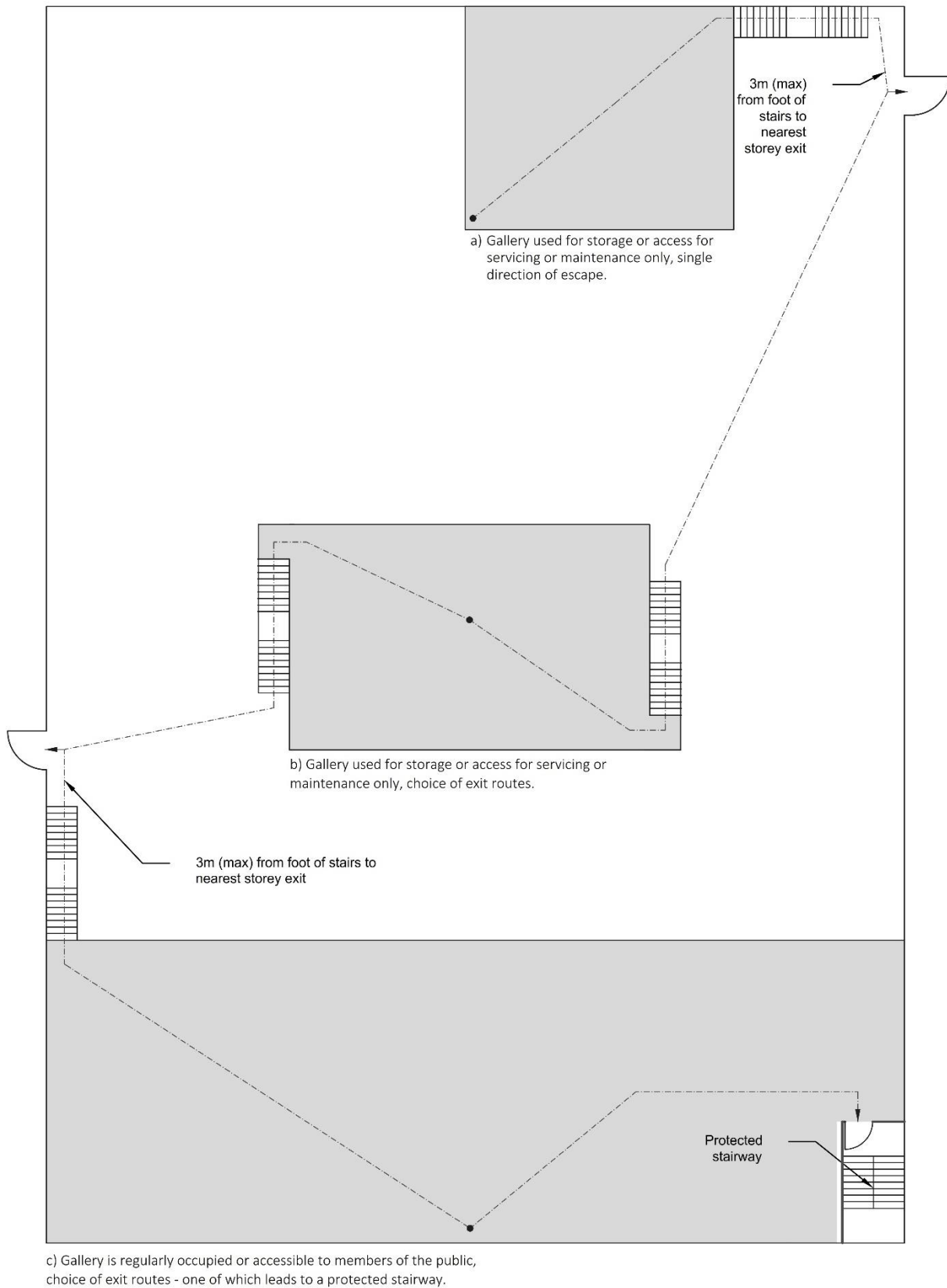

Notes:

- (1) For provision of fire resisting construction, see [Appendix A](#).
- (2) For provision of fire doors, see [Appendix B](#).
- (3) For a gallery which is regularly occupied, or accessible to members of the public, see [Diagram 5](#)

1.4.4 Corridors

1.4.4.1 Provision of Protected Corridors

A corridor which serves as part of the means of escape in any of the following circumstances should be a protected corridor (see [Appendix A, Table 31](#)):

- (a) Every corridor serving sleeping accommodation within a residential (care facility); or residential (other) building (Purpose Groups 2(a) (ii) or 2(b)); or
- (b) Every dead end corridor in a day centre building (Purpose Group 5(b)(i)); or
- (c) Every dead-end corridor exceeding 4.5 m in length; or
- (d) Every corridor common to two or more different occupancies (see [Para 1.4.3.8](#)).

1.4.4.2 Enclosure of Protected Corridors

Protected corridors should be:

- (a) carried up to the underside of the structural floor or roof above (see [Diagram 8 \(a\)](#)); or
- (b) carried up to meet a fire-resisting suspended ceiling (see [Diagram 42\(b\)](#)) which extends throughout the building, compartment or separated part (see [Diagram 8 \(b\)](#)); or
- (c) carried up to a suspended ceiling and be fitted with cavity barriers on the line of the enclosure(s) of the corridor (see [Diagram 8 \(c\)](#), and [Subsection 3.6](#)).

Where a protected corridor is required to be subdivided, a cavity barrier should be provided above any door partition/screen which is not carried to full storey height.

1.4.4.3 Enclosure of Corridors That Are Not Protected Corridors

Enclosures/partitions to corridors should be carried up to the underside of the structural floor or suspended ceiling. All openings in non-protected corridor enclosures/partitions should be fitted with doors which need not be fire doors.

While these partitions and doors are not required to have a fire resistance rating, they do provide some defence against the spread of smoke in the early stages of fire.

1.4.4.4 Subdivision of Corridors

If a corridor, whether protected or non-protected, provides access to alternative escape routes, there is a risk that smoke will spread along it and make both routes impassable before all occupants have escaped.

To avoid this, every corridor connecting two or more storey exits where the distance between storey exits exceeds 12 m should be subdivided into two corridor sections by self-closing fire doors (and any necessary associated fire-resisting construction which may be glazed) so that:

- (a) no length of undivided corridor is common to two storey exits; and
- (b) the fire door(s) are positioned approximately mid-way between the two storey exits to effectively safeguard the route from smoke, having regard to the layout of the corridor and to any adjacent fire risks.

Section 1: Means of Warning and Escape in Case of Fire

Diagram 8 Enclosure / Subdivision of Protected Corridors

Para 1.4.4.2

(a) Carried up to the underside of the structural floor or roof

- Suspended ceiling (non fire-resisting)
- Protected corridor walls carried up to the underside of the structural floor or roof
- Corridor subdivision (where required)

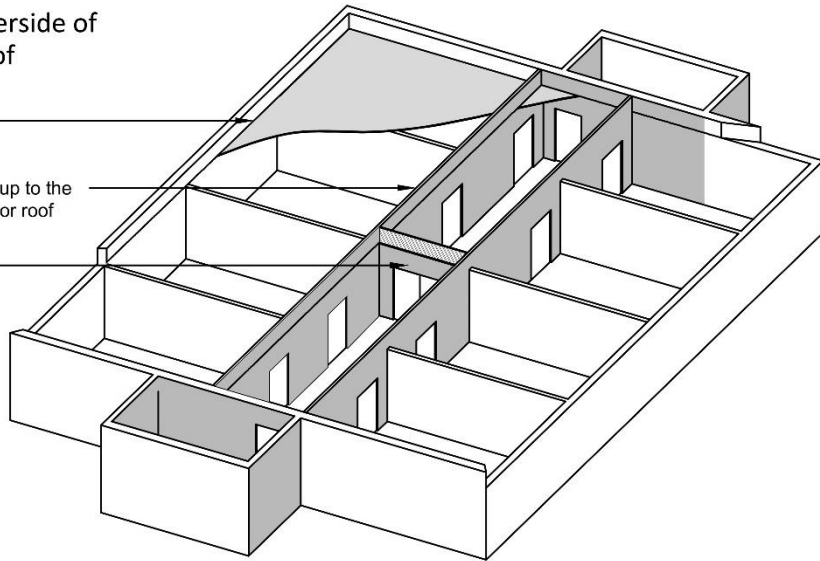

(b) Carried to meet a fire resisting suspended ceiling which extends throughout the building, compartment or separated part

- Fire-resisting ceiling
- Corridor subdivision (where required)

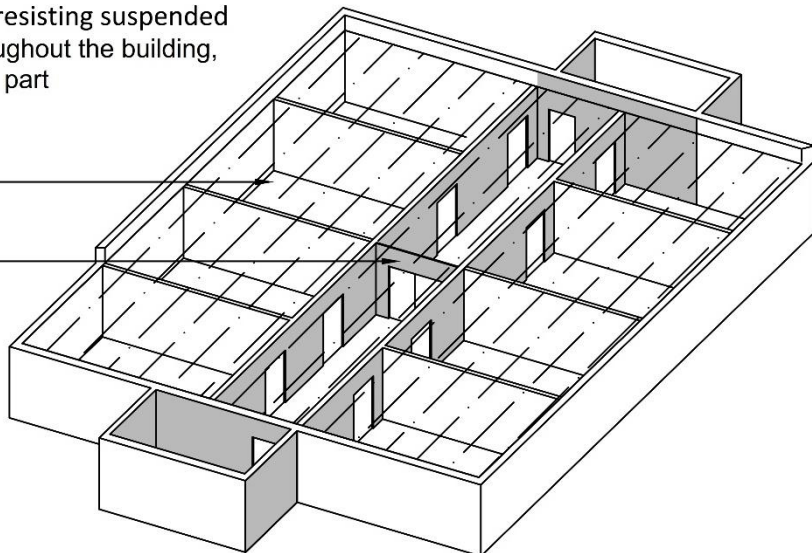

(c) Carried up to a non-fire resisting suspended ceiling and be fitted with cavity barriers on the line of the enclosure(s) of the corridor

- Suspended ceiling (non fire-resisting)
- Cavity barriers
- Corridor subdivision (where required)

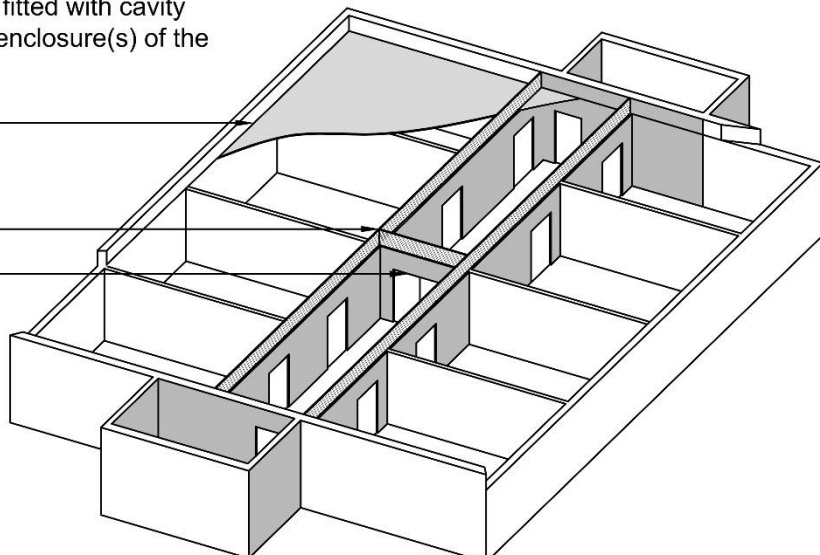

Section 1: Means of Warning and Escape In Case of Fire

1.4.4.4.1 Methods of Subdividing Corridors

In a Purpose Group 2 to 8 building, where a non-protected corridor is subdivided and a cavity exists above the enclosures, smoke spread should be restricted by one of the following measures:

- (a) Fitting cavity barriers on the line of the enclosure(s), and above the corridor door (see [Diagram 9](#) (a), and [Subsection 3.6](#)); or
- (b) Subdividing the storey using fire-resisting construction to full storey height passing through the line of the subdivision of the corridor. Any door which could provide a path for smoke to bypass the subdivision should be a self-closing fire door (see [Diagram 9](#) (b)); or
- (c) Enclosing the cavity on the lower side by means of a fire-resisting ceiling (see [Diagram 42](#) (b)) which extends throughout the building, compartment or separated part (see [Diagram 9](#) (c)).

1.4.4.5 Separation of Dead Ends

If a dead-end portion of a corridor provides access to a point from which alternative escape routes are available, there is a risk that smoke from a fire could make both routes impassable before the occupants in the dead-end have escaped.

Every dead-end corridor exceeding 4.5 m in length should be separated by self-closing fire doors (together with any necessary associated screens) from any part of the corridor which:

- (a) continues past one storey exit to another ([Diagram 10\(a\)](#)); or
- (b) provides two directions of escape ([Diagram 10](#) (b)).

The above requirement does not apply where the escape stairway(s) and dead end portion(s) of corridors are protected by a pressurisation system complying with I.S. EN 12101-6.

In school (Purpose Group 5(a) (ii)) building, with more than one stairway, dead end corridors should be avoided.

Section 1: Means of Warning and Escape in Case of Fire

Diagram 9 Subdivision of Corridors that are Not Protected

Para 1.4.4.4

(a) Cavity barriers above suspended ceiling, on corridor lines

Suspended ceiling
(non fire-resisting)

Cavity barriers

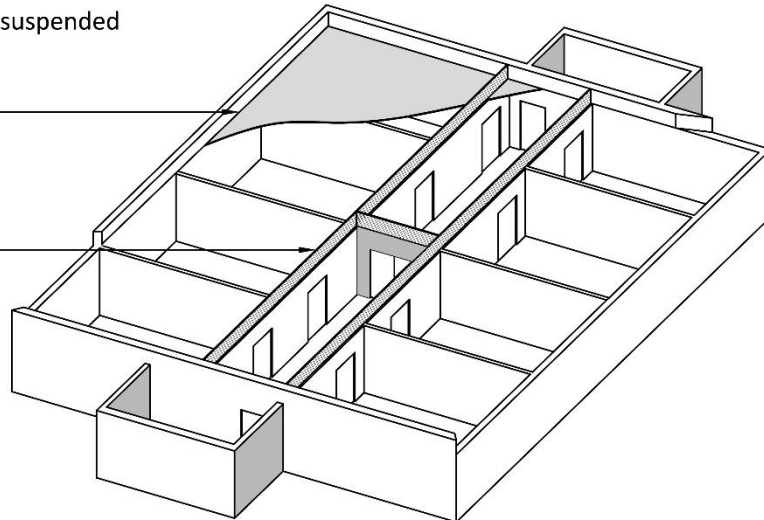

(b) Subdividing storey using fire resisting construction

Suspended ceiling
(non fire-resisting)

Storey-dividing
fire-resisting
partition

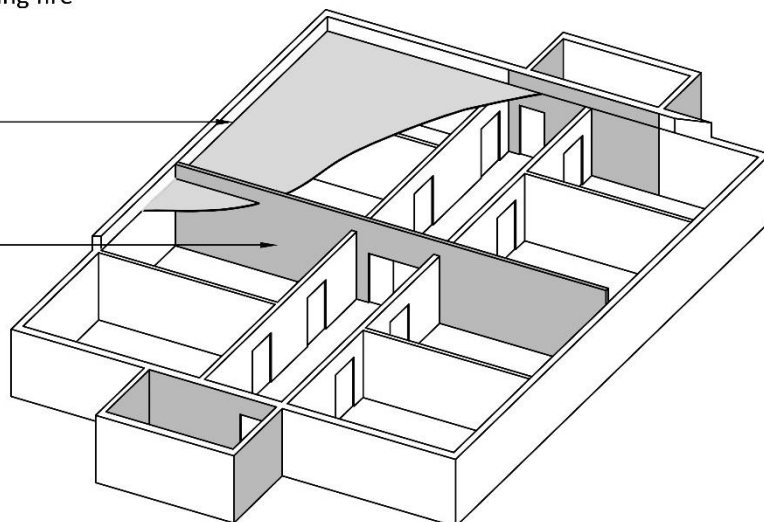

(c) Enclosing the cavity on the lower side by a fire-resisting ceiling

Fire-resisting ceiling

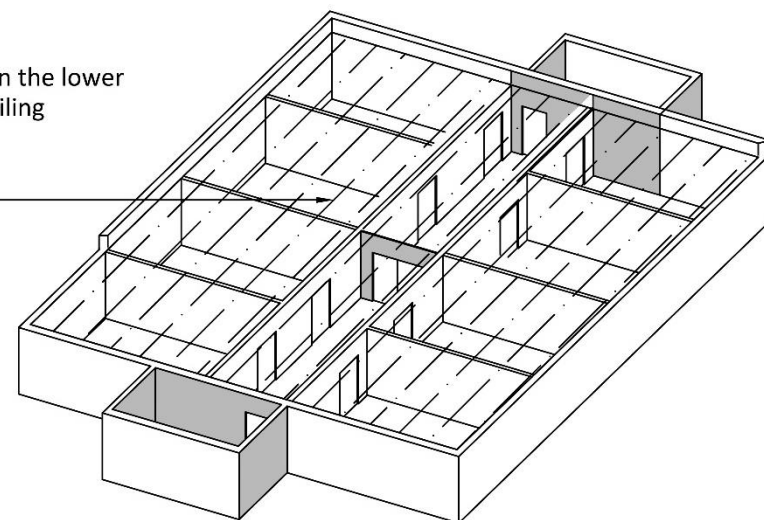

Note:

- (1) A fire resisting ceiling should
 - (a) have at least 30 minutes' fire-resistance;
 - (b) be imperforate except for an opening allowed under [Para 3.6.5](#);
 - (c) extend throughout the building or compartment;
 - (d) not be demountable; and
 - (e) have a Class B - s3, d2 surface on the soffit, and at least a Class C-s3, d2 surface facing the cavity.

Diagram 10 Dead-End Corridors

Para 1.4.4.5

(a) Continuation past escape stairways

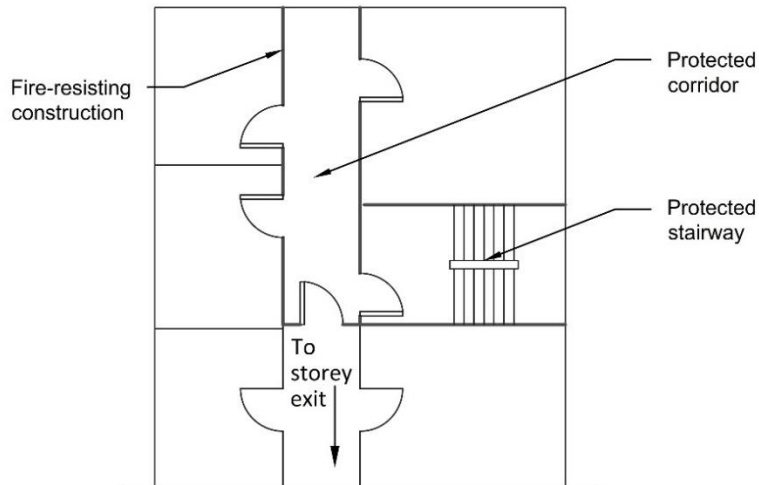

(b) T - Junction with main corridor

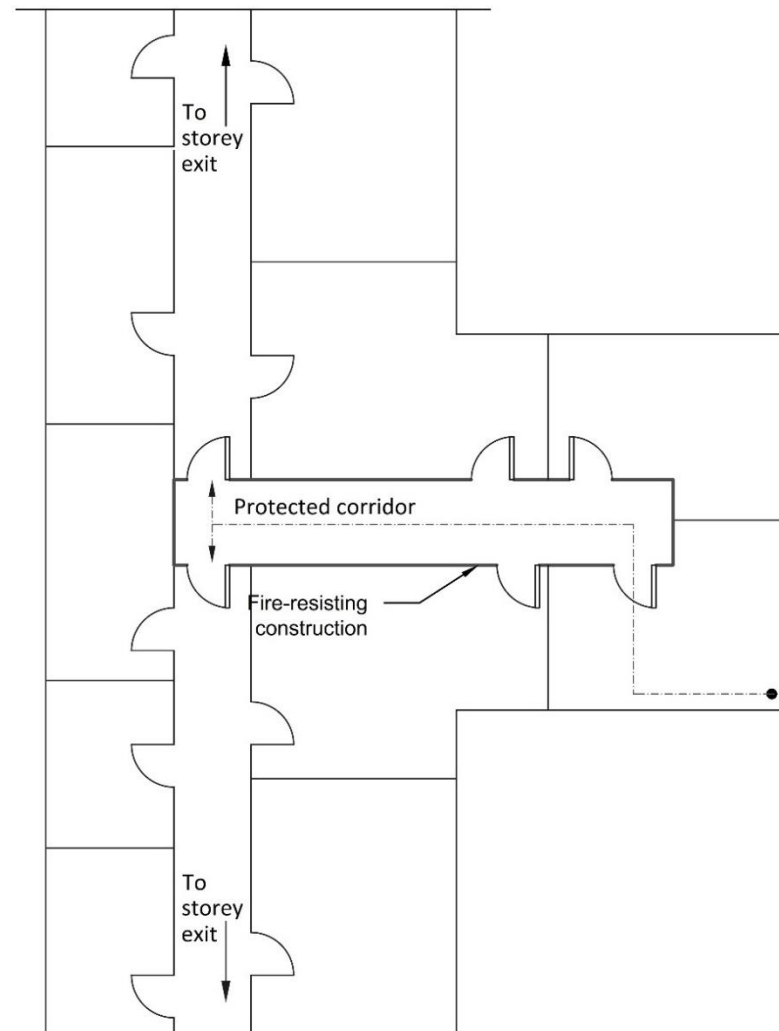

Notes:

- (1) Travel distances in a single direction should not exceed the values given in [Table 3](#)
- (2) Corridors that provide access to two or more storey exits should be effectively subdivided, midway along their length where the distance between storey exits exceeds 12 m.
- (3) For provision of fire resisting construction, see [Appendix A](#)
- (4) For provision of fire doors, see [Appendix B](#)

Section 1: Means of Warning and Escape in Case of Fire

1.4.5 Evacuation Considerations for Residential (Care Facility) Buildings, (Purpose Group 2(a)(ii))

1.4.5.1 General

In a residential (care facility) building (Purpose Group 2(a)(ii)), occupants may be totally dependent on other people for evacuation. Normal "self-help" evacuation procedures are therefore inappropriate, and consideration must be given to designing escape routes to facilitate the planned mode of evacuation.

The following provisions allow progressive horizontal escape to be made into adjoining compartments in a residential (care facility) building (Purpose Group 2(a)(ii)).

The object is to provide a place of relative safety within a short distance, from which further evacuation can be achieved, but under less pressure of time.

Provisions relating to sprinklers in shopping centres are set out in [Section 8](#).

1.4.5.2 Compartmentation

A residential (care facility) building (Purpose Group 2(a)(ii)) should be divided into at least two compartments in such a way as to permit horizontal evacuation of each compartment.

An exception to this may be made in storeys which consist exclusively of ancillary accommodation (e.g.: kitchen, storage rooms, staff areas, laundry).

1.4.5.3 Designing for Progressive Horizontal Evacuation

In designing a storey which is divided into compartments for progressive horizontal evacuation, the following conditions should be observed:

- (a) Adjoining compartments into which horizontal evacuation may take place should each have a floor area sufficient to accommodate, not only their own occupants, but also the occupants from the adjoining compartment. This should be calculated on the basis of the design occupancy of the compartments.
- (b) Each compartment should have at least one other escape route, independent of the route into the adjoining compartment (see [Diagram 11](#)). This other route may be by way of a third compartment, provided that compartment contains a storey exit which is not by way of another compartment, and which is independent from the exits from the other compartments.

Where the above conditions have been met, for the purpose of travel distance (see [Para 1.4.2.2](#)), a door in a compartment wall may be regarded as being equivalent to a storey exit.

In an unsprinklered building (see [Section 8](#)), the maximum number of bed spaces in a compartment should not exceed 10 bed spaces.

Section 1: Means of Warning and Escape in Case of Fire

1.4.5.4 Escape route widths in Residential (Care Facility) Buildings (Purpose Group 2(a)(ii))

In residential (care facility) buildings (Purpose Group 2(a)(ii)) an escape route should generally be not less than 1.15 m in width and where appropriate, should be suitably designed to allow the movement of beds along the escape route.

The width of an exit from any room should not be less than 0.9 m.

The width of a final exit should be not less than 1.15 m.

1.4.5.5 Door-Closing Devices

Fire doors are required to have self-closing devices (see [Appendix B](#)). Where self-closing doors could present an obstacle to the residents of the building, then the following hardware in accordance with I.S. EN 1155 should be provided, either:

- (a) bedrooms – free-swing door closers; or
- (b) circulation spaces – hold-open devices.

1.4.5.6 Bedrooms

A wall between a bedroom and any room that is not a bedroom, should be fire resisting in accordance with [Appendix A, Table 31](#). This provision applies irrespective of the installation of a sprinkler system.

Walls between bedrooms should be fire resisting, in accordance with [Appendix A, Table 31](#). An exception to this requirement is where the building is provided with a sprinkler system in accordance with [Section 8](#). In such a building, a wall between a bedroom and another bedroom, need not be fire resisting, but should conform to one of the following:

- (a) Extend to the underside of the fire-resisting floor or roof above; or
- (b) Extend to a non-fire-resisting ceiling, with cavity barriers on the line of bedroom walls in the void (a), (see [Subsection 3.6](#)); or
- (c) Extend to a fire-resisting ceiling, which extends throughout the compartment (see [Diagram 42\(b\)](#)).

A bedroom ensuite may be taken to form part of the bedroom.

Section 1: Means of Warning and Escape in Case of Fire

Diagram 11 Progressive Horizontal Evacuation in Residential (Care Facility) Buildings

Para 1.4.5.3

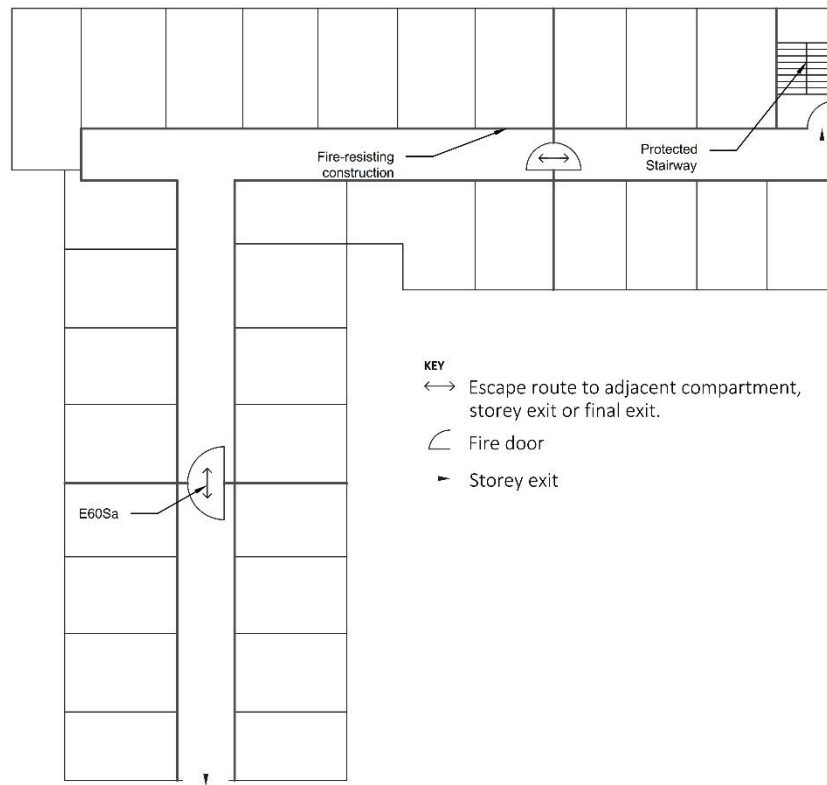

Notes:

- (1) Walls between bedrooms should be fire-resisting where sprinklers are not provided.
- (2) Walls between bedrooms and ancillary accommodation should be fire-resisting.
- (3) Administrative areas (nurse's stations) may be open to protected corridors where sprinklers are provided.
- (4) For provision of sprinklers, see [Section 8](#).
- (5) For provision of fire resisting construction, see [Appendix A](#)
- (6) For provision of fire doors, see [Appendix B](#)

1.4.6 External Escape Routes

1.4.6.1 External Escape Stairway

If more than one escape route is required from a storey, or part of a building, one of those routes may be by way of an external escape stairway, provided that:

- (a) The stairway does not serve a storey more than 11 m above ground level, and
- (b) In the specific case of:
 - (i) an assembly and recreation building, the route is not intended for use by members of the public; or
 - (ii) a residential (care facility) building (Purpose Group 2(a)(ii)), the route serves only office or residential staff accommodation.

External escape stairways should comply with the requirements set out in [Para 1.5.9](#).

1.4.6.2 Escape Over Flat Roofs

If more than one escape route is required from a storey or part of a building, one of those routes may be by way of a flat roof, provided that the following provisions are met:

- (a) The route should not serve a residential (care facility) building (Purpose Group 2(a)(ii)), or a part of a building intended for use by members of the public; and
- (b) The roof should be part of the same building from which escape is being made; and
- (c) The route across the roof should lead to a storey exit; and
- (d) The part of the roof forming the escape route and its supporting structure, together with any opening within 3 m of the escape route, should have a fire resistance as set out in Appendix A, [Table 31](#); and
- (e) The route should be clearly defined.

Guidance with respect to the provision of guarding to prevent falls is set out in Technical Guidance Document K (Stairways, Ladders, Ramps and Guards).

1.4.6.3 Escape Over a Podium

The provisions of [Para 1.4.6.2](#) also apply to an escape route over a podium which gives direct access to a place of safety and where the podium is constructed of materials having a reaction to fire classification achieving Class A2 – s3, d2, and having a fire resistance as set out in Appendix A, [Table 31](#).

There may be additional fire resistance requirements if this is also the main fire service access to a firefighting shaft (see [Section 5](#)).

Section 1: Means of Warning and Escape in Case of Fire

1.4.7 Audience and Spectator Facilities

There are particular problems that arise when fixed seating limits people's ability to escape. Any such arrangements made for a closely seated audience (or closely seated spectators, including in bleachers) should meet the provisions of the following paragraphs.

For design with respect to handrails and guarding, see Technical Guidance Document K (Stairways, Ladders, Ramps and Guards). For design with respect to access and use of audience and spectator facilities, see Technical Guidance Document M (Access and Use).

1.4.7.1 Tiered Seating

The number of seats in a row should be in accordance with [Table 6](#).

Seatway widths should be not less than 0.3 m and should be constant throughout the length of the row.

Where seats tip up automatically, (see [Diagram 12](#)) the seatway width should be measured between the back of one seat unit and the maximum projection of the seat unit behind when the seat is in the up position.

The slope of a tier of seating should not exceed 35° above the horizontal.

The number of steppings in a tier uninterrupted by cross-gangways should not exceed 40 if the rake exceeds 25°.

1.4.7.2 Gangways

1.4.7.2.1 Widths of Gangways

Gangways (see [Diagram 12](#)) should:

- (a) be not less than 0.9 m wide where less than 50 persons are expected to use them;
- (b) be not less than 1.1 m wide where more than 50 persons are expected to use them;
- (c) not have obstructions which reduce the clear width of the gangway, (handrails which do not intrude more than 100 mm into the gangway may be ignored); and
- (d) maintain a uniform width throughout the length of the gangway. Where the escape flow is in one direction only (i.e. access to any alternative means of escape is along the rows), the gangway may widen towards the storey exit.

1.4.7.2.2 Design of Gangways

Intersections of transverse and radial gangways in auditoria with tiered seating should form a "T" junction.

Connections between transverse and radial gangways should be offset to ensure a smooth flow to the exits.

Section 1: Means of Warning and Escape In Case of Fire

In stepped tiers, the height of each step in a gangway should be not less than 100 mm and should not exceed 190 mm. Where there are two or more rises to each row of seats, each step should be of equal height.

1.4.7.2.3 Access to Storey Exits

Storey exits should:

- (a) be approached from the side by transverse gangways when provided within the body of a seating layout; and
- (b) have a landing which is at least the width of the exit and at least 1.1 m deep immediately in front of the exit doors, when approached from a stepped gangway.

Diagram 12 Seatways and Gangways in Audience and Spectator Facilities **Para 1.4.7**

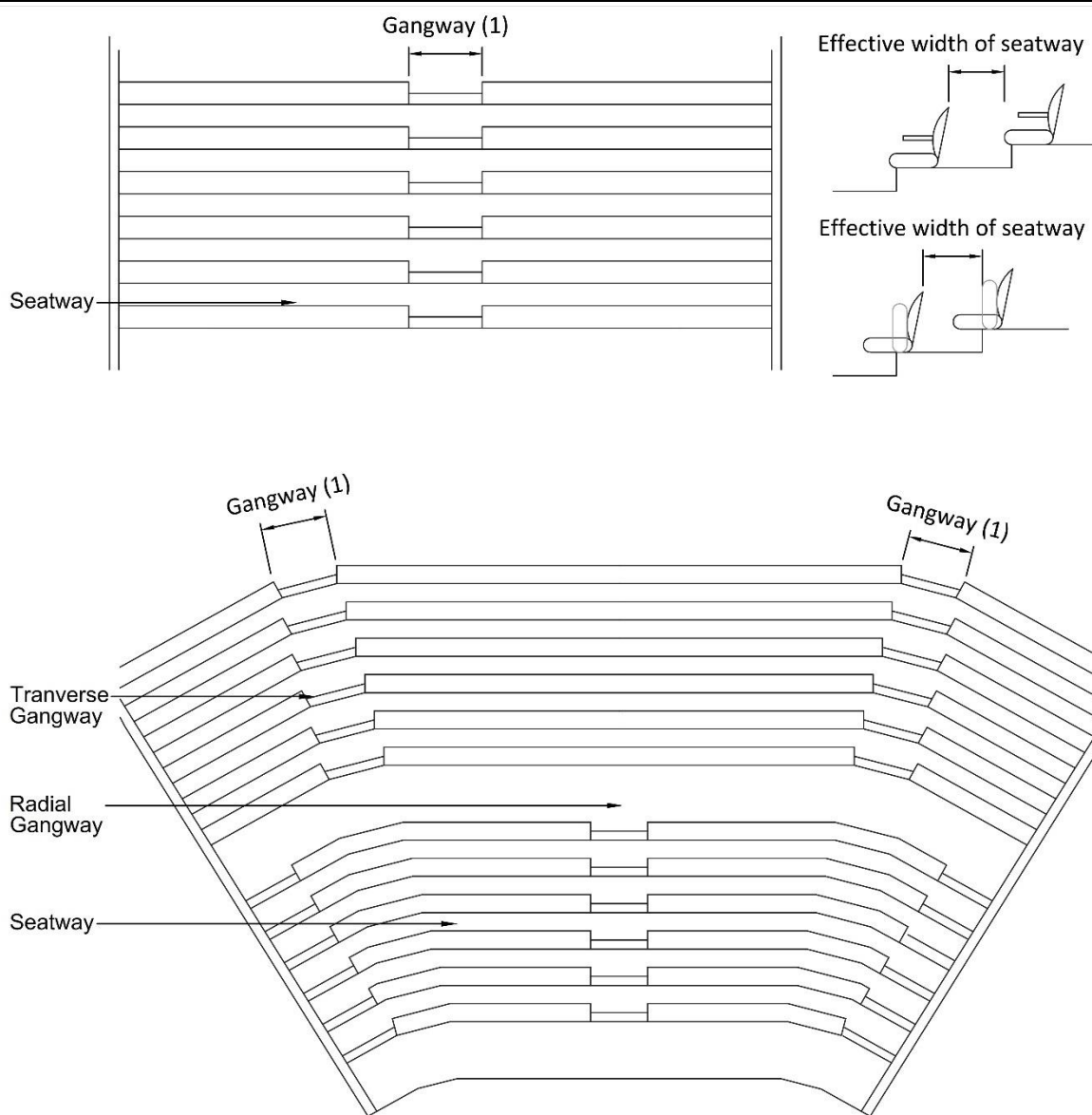

Notes:

- (1) Min 0.9m for < 50 persons, Min 1.1m for > 50 persons

Section 1: Means of Warning and Escape in Case of Fire

Table 6 Gangway Seating		Para 1.4.7.2
	Maximum no. of seats in a row	
Minimum seatway width (mm)	Gangway on one side	Gangway on two sides
300	up to 7	up to 14
325	up to 8	15/16
350	up to 9	17/18
375	up to 10	19/20
400	up to 11	21/22
425	up to 12	23/24
450	up to 12	25/26
475	up to 12	27/28
500+	up to 12	Limited by travel distance

1.4.8 Premises Provided with a Stage

Stage areas present particular problems in that they present additional fire risk due to the presence of combustible materials. These provisions apply where dedicated stage areas with ancillary rooms (scene docks, dressing rooms, etc.) are designed.

These provisions do not apply to stage areas with a low fire load e.g., temporary stages, small community / village halls, school halls, lecture halls or similar.

For fire resistance requirements of areas ancillary to the stage, see [Para 3.4.4.7](#).

For sprinkler systems in stage areas, see [Section 8](#).

1.4.8.1 Stage Areas

1.4.8.1.1 Means of Escape from Stage Areas

Escape routes from the stage and the stage basement should comply with Para's 1.4.1 to 1.4.4, and travel distances should comply with those listed in [Table 3](#) for "other areas".

Protected lobbies should be provided between:

- (a) a stage and the dressing room corridor(s); or
- (b) a stage and a final exit to the open air; or
- (c) a stage and the auditorium, when a pass door is provided in a proscenium wall; or
- (d) a stage basement and the orchestra pit.

1.4.8.1.2 Separation of Stage Areas

A proscenium wall, where provided, should be constructed of materials having a reaction-to-fire classification achieving Class A2-s3, d2, when classified in accordance with I.S. EN 13501-1 and having a standard of fire resistance equivalent to that required for the elements of construction of the building, but no less than 60 minutes (see Appendix A, [Table 31](#)). The wall should be carried up from the lowest level of the stage basement to the under-side of the roof.

Section 1: Means of Warning and Escape in Case of Fire

Where a safety curtain is provided, it should either:

- (a) conform to the following:
 - (i) be made of material with a reaction-to-fire classification achieving Class A2-s3, d2, when classified in accordance with I.S. EN 13501-1; and
 - (ii) be capable of withstanding a pressure differential of 0.5 kPa over its entire surface; and
 - (iii) be so fitted that when fully lowered it inhibits the penetration of smoke around the perimeter of the opening from the stage; or
- (b) be a smoke curtain tested in accordance with IS EN 12101-1, with a tested performance of no less than 60 minutes.

1.4.8.1.3 Grids and Galleries

Any grid and galleries, including lighting galleries and perches, should be of materials having a reaction-to-fire classification achieving Class A1.

The working fly gallery(s) and the grid should each be provided with an escape route independent of the stage by way of:

- (a) a storey exit to an external route; or
- (b) a doorway to another part of the building leading to a storey exit.

1.4.8.2 Ventilation of Stage Areas

Open stages should be ventilated in accordance with [Para 6.9.1](#).

Separated stages should be ventilated in accordance with [Para 6.9.2](#).

1.4.8.3 Dressing Rooms

Escape from dressing rooms should be in accordance with the recommendations of Section 1. Travel distances should not exceed those given in [Table 3](#).

An alternative means of escape, which is independent of the stage should be provided.

For the provision of fire resisting construction, see [Para 3.4.4.7\(d\)](#).

1.4.8.4 Scene Docks

Any opening between a scene dock and the stage should be protected by a fire door. Scene docks should be ventilated in accordance with Section 6, [Para 6.9.1](#).

For the provision of fire resisting construction, see [Para 3.4.4.7\(d\)](#).

Section 1: Means of Warning and Escape In Case of Fire

1.4.9 Student Accommodation Unit (Purpose Group 2 (b))

A student accommodation building (see [Diagram 13](#)), provided with a single escape stairway should be acceptable where:

- (a) it is designed only for the purpose of accommodating students.
- (b) Each individual student accommodation unit should be separated from any other part of the building by compartment walls and floors, in accordance with [Para 3.4.4.4](#).
- (c) All habitable rooms should be accessed directly from a protected entrance hallway, which delivers to a common protected lobby/corridor.
- (d) The maximum travel distance in the protected entrance hallway is 9 m, but this may be increased to 15 m, where a sprinkler system is provided within the unit.
- (e) The protected entrance hallway should have the appropriate fire resistance as specified in [Appendix A, Table 31](#) and [Table 32](#).
- (f) All doors forming part of the fire-resisting enclosure of the protected entrance hallway should be fire doors fitted with self-closers (a fire door to a hotpress does not need a self-closer), and have the appropriate fire resistance specified in [Appendix B](#).
- (g) The walls forming the protected entrance hallway (excluding the compartment wall separating the unit from any other part of the building) should:
 - (i) be carried to the underside of the structural floor, or roof above, and be appropriately fire stopped (see [Diagram 13\(b\)](#)); or
 - (ii) be carried to a ceiling which is not fire resisting, with cavity barriers placed in any void, along the lines of the protected entrance hallway, to limit the spread of smoke (see [Diagram 13\(c\)](#)); or
 - (iii) be carried to a fire-resisting ceiling, which extends throughout the compartment(see [Diagram 13\(d\)](#)).
- (h) Any penetrations of the protected entrance hallway should be fire-stopped in accordance with [Subsection 3.7](#).
- (i) The communal area within the student accommodation unit, which may consist of a kitchen, dining and sitting area, should be enclosed fire-resisting construction (having a fire resistance as set out in Appendix A, [Table 31](#)), and should be accessed from the dead end of the protected entrance hallway within the unit. No other main cooking appliance should be provided within the unit.
- (j) Escape within the common parts of the building should conform to the relevant provisions under Paras [1.6.6](#), and [1.6.7](#), including the provisions of [Para 1.6.7.1](#) for buildings with a topmost floor level of more than 30 m.

Where the above provisions are not met, the student accommodation should be designed as a Hall of Residence meeting the relevant provisions of Subsection 1.4 and 1.5 for horizontal means of escape, including the provision of no less than 2 escape stairways where any storey has a height greater than 11 m.

For sprinkler systems in student accommodation units, see [Section 8](#).

Section 1: Means of Warning and Escape in Case of Fire

Diagram 13 Student accommodation unit

Para 1.4.9

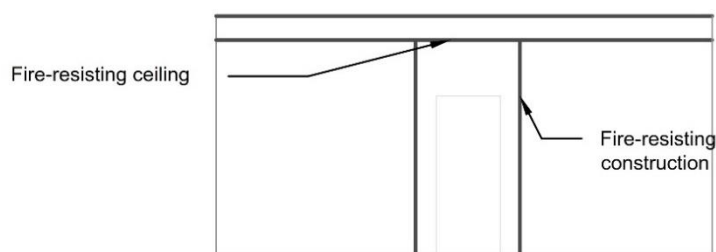
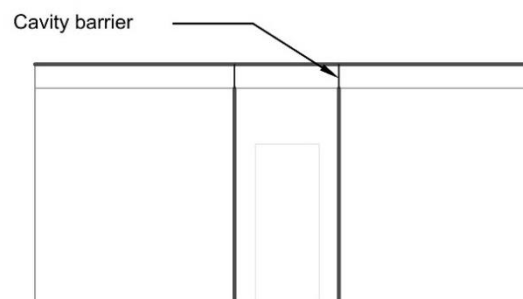
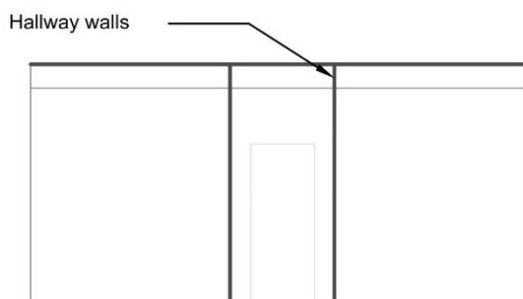
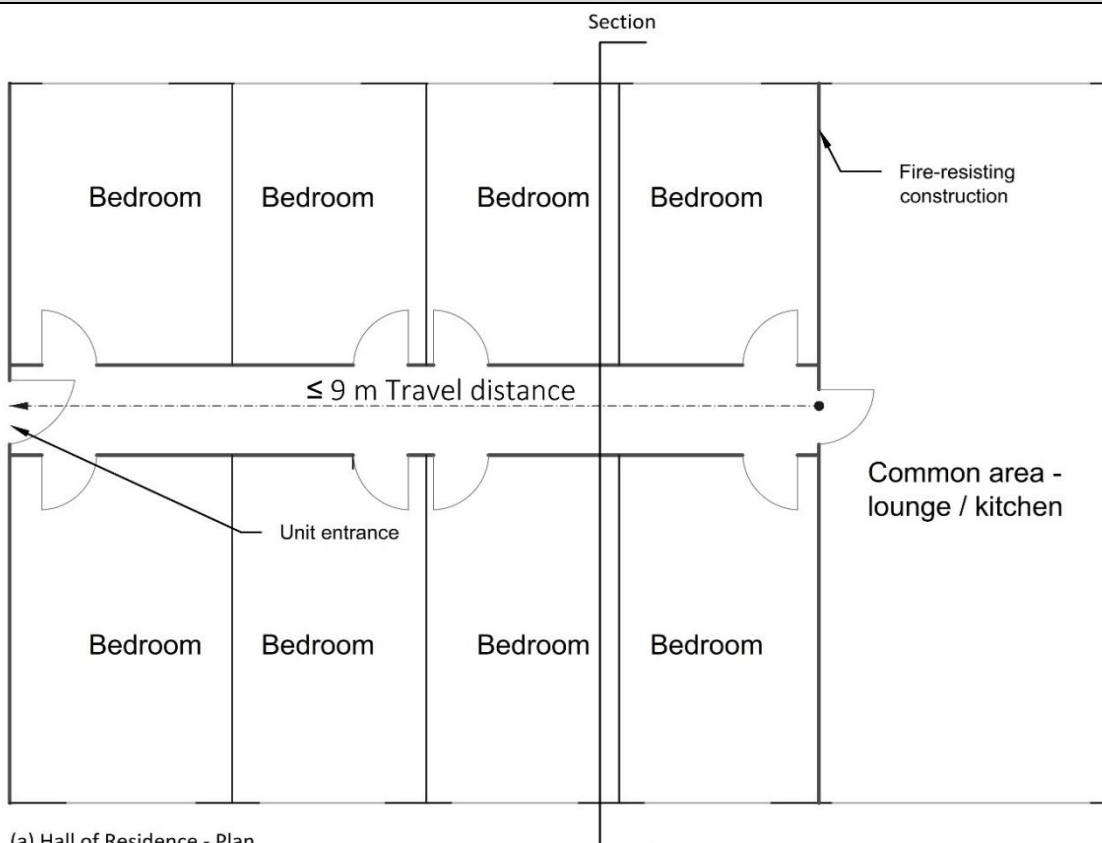

Notes:

- (1) The maximum travel distance in the protected entrance hallway is 9m, but this may be increased to 15m, where a sprinkler system is provided within the unit.
- (2) For compartmentation, see [Section 3](#).
- (3) For sprinkler systems, see [Section 8](#)
- (4) For provision of fire resisting construction, see [Appendix A](#).
- (5) For provision of fire doors, see [Appendix B](#).

1.5 Design for Vertical Escape

1.5.1 Introduction

An important aspect of means of escape in multi-storey buildings is the availability of a sufficient number of adequately sized and protected escape stairways.

This section deals with these matters, including measures necessary to protect escape stairways, for all types of building other than hospitals (see [Para 1.2.1](#)).

Generally, all upper floors in multi-storey buildings are required to have at least two escape stairways. There are circumstances where this principle may be varied, as set out under Para's 1.5.2 and 1.5.3.

1.5.2 Number of Escape Stairways

The number of escape stairways needed in a building (or part of a building) will be determined by:

- (a) where a single stairway is acceptable by virtue of the height or use of the building (see [Para 1.5.3](#));
- (b) where the provisions in respect of a small premises (see [Subsection 1.8](#)) applies;
- (c) the constraints imposed in [Subsection 1.4](#) on the design of horizontal escape routes;
- (d) whether independent stairways are required in mixed occupancy buildings (see [Para 1.5.2.2](#)).

In all circumstances, stairs should be adequately sized to facilitate the evacuation of the occupants of the building (see [Para 1.5.4](#) and [Para 1.5.5](#)).

1.5.2.1 Large Buildings

In large buildings, provisions for access for the fire service may apply. Where firefighting shafts are provided (see [Para 5.5.5](#)), the stairway within the shaft may be used as a means of escape. The number of stairs required in such a building may be affected by the requirements of Section 5.

1.5.2.2 Buildings Containing Different Purpose Groups

In buildings containing different purpose groups, escape routes are not required to be independent except in the case of assembly and recreational (Purpose Group 5(a) and 5(b)), or residential (Purpose Group 1(c), Purpose Group 2(a) or Purpose Group 2 (b)) uses.

An exception to the requirement for independent escape routes in residential occupancies is where it is a building containing flats (Purpose Group 1(c)) and the criteria of [Para 1.5.2.2.1](#) or [Para 1.5.2.2.2](#) are met.

Section 1: Means of Warning and Escape in Case of Fire

1.5.2.2.1 Buildings with Not More Than Four Stories

In a building with not more than four storeys above ground or access level, a stairway may serve both flats and non-residential (Purpose Groups 3 to 8) uses where:

- (a) the stairway is separated from each occupancy by protected lobbies (see [Para 1.5.8](#)) at all levels; and
- (b) an automatic fire detection and alarm system is provided throughout the building (see [Para 1.9.13](#)).

1.5.2.2.2 Buildings with More Than Four Stories

In a building with more than four storeys above ground or access level, all stairways serving the flat or maisonette should not communicate with any other use unless all the following are met:

- (a) there is only one flat or maisonette, which is ancillary to the main use of the building; and
- (b) the stairway is separated from each occupancy by protected lobbies (see [Para 1.5.8](#)) at all levels; and
- (c) an alternative escape route is provided from the flat; and
- (d) an automatic fire detection and alarm system is provided throughout the building (see [Para 1.9.13](#)).

1.5.3 Single Escape Stairways

The situations where a building (or part of a building) other than a residential (care facility) building (Purpose Group 2(a)(ii)) may be served by a single escape stairway are as follows:

- (a) an assembly and recreation building (Purpose Group 5(a)), or a Day Centre building (Purpose Group 5(b)(ii), where there is no storey more than 5 m above ground level; or
- (b) a day centre building (Purpose Group 5(b)(i)), where the premises consists of a ground floor storey and one upper storey (first floor level) and the building has been designed such that not more than 20 children can be accommodated on the upper storey; or
- (c) In the case of a stairway serving a part of a building containing flats (Purpose Group 1(c)), which is in accordance with the requirements specified in [Subsection 1.6](#), for a single-stairway building; or
- (d) In the case of all other purpose groups, where there is no storey more than 11 m above ground level; or
- (e) In the case of a basement, the floor of which is not more than 3 m below ground level.

In all cases, the single escape route should be in accordance with [Para 1.4.2.5](#).

1.5.4 Width of Escape Stairway

The width of escape stairways should:

- (a) be not less than the width(s) required for any exit(s) affording access to them; and
- (b) conform with the minimum widths given in [Table 7](#); and
- (c) not exceed 1.4 m if serving any storeys more than 30 m above ground level; and
- (d) not reduce in width at any point on their way to a final exit.

If the width of the stairway is more than 1.8 m, then for reasons of safety in use the stairway should have a central handrail. In such a case, the stairway width on each side of the handrail needs to be considered separately for the purpose of assessing stairway capacity.

Table 7 Minimum Width of Escape Stairways		Para 1.5.4
Situation	Maximum number of persons⁽¹⁾	Minimum width (m)⁽⁴⁾
1. In any building, serving an area which can accommodate more than 100 people.	150	1.0
	220	1.1
	More than 220	5mm per person ⁽²⁾⁽³⁾
2. In a residential (care facility) building (Purpose Group 2(a)(ii)), (unless it will be used only by staff)		1.15
3. In an assembly and recreation building (Purpose Group 5), serving an area which can accommodate less than 100 people	100	0.9
4. Any stairway not described above.	50	0.8
	100	0.9
Notes: (1) Designed for the number of persons calculated to use the stairway in the event of a fire. (2) See Para 1.5.5.3 and Table 8 for capacity of stairways when designing for total evacuation of the building. (3) See Para 1.5.5.4 and Table 9 minimum aggregate width of stairways designed for phased evacuation. (4) The minimum widths given in the table may need to be increased in accordance with the guidance in TGD M (Access and Use), but only where the stairs is designed for ambulant disabled access.		

Section 1: Means of Warning and Escape in Case of Fire

1.5.4.1 Converging Flows at Final Exit

Where a ground-floor storey exit and a stair share a final exit (via a ground-floor lobby), then the final exit should be wide enough to evacuate people at a maximum flow rate equal to or greater than from the storey exit and stair combined (see [Diagram 14](#)).

This can be calculated using the formula: $W = ((N/2.5) + (60S))/80$

Where

W is the width of final exit in metres

N is the number of people served by ground-floor storey exit

S is the stair width in metres.

If the number of people (N) entering the lobby from the ground storey is more than 60, then the distance from the foot of the stair or the storey exit to the final exit (D) should be a minimum of 2 m. If that minimum distance cannot be achieved, the width of the final exit (W) should be at least the width of the stair plus the width of the storey exit.

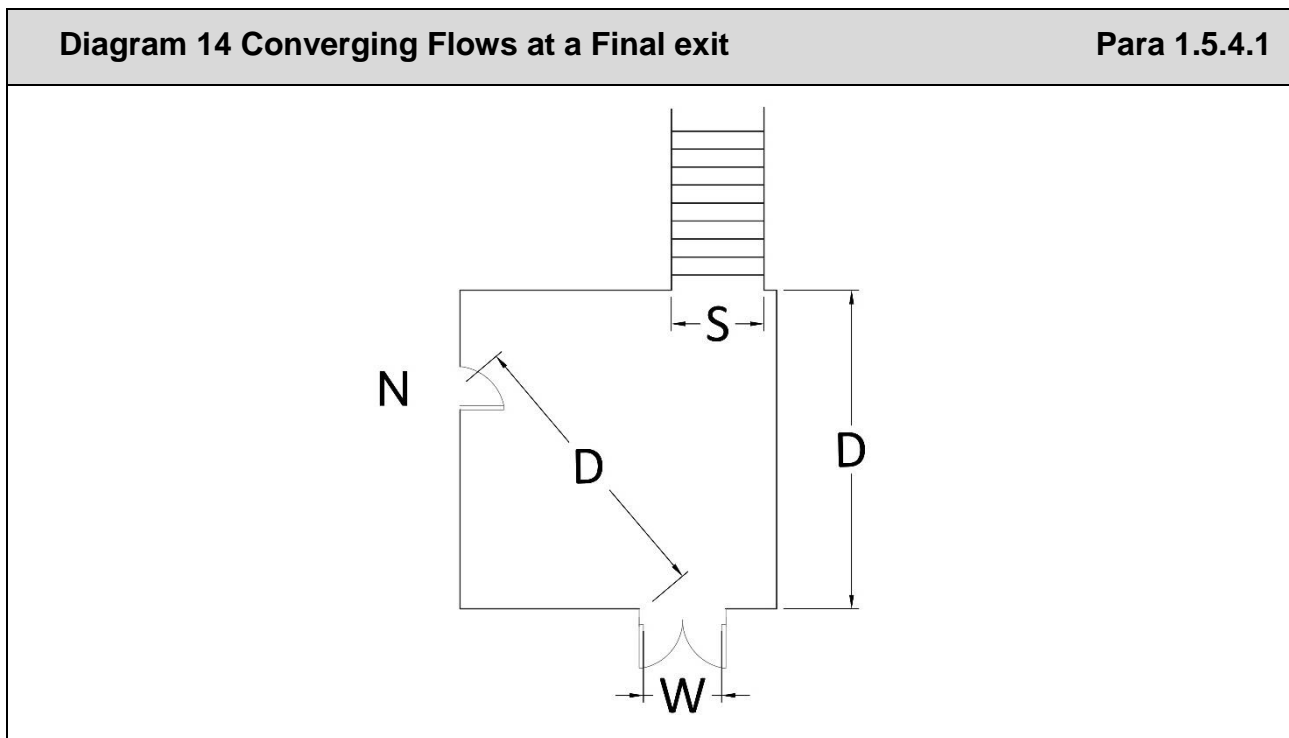

1.5.4.2 Landings in Residential (Care Facility) Buildings (Purpose Group 2(a)(ii))

In residential (care facility) building (Purpose Group 2(a)(ii)), any landing associated with a stairway forming part of an escape route should be adequate for the purposes of evacuation. Any landing associated with such a stairway should have a width not less than 2.8m and a depth clear of obstructions not less than 1.95 m.

1.5.5 Calculation of Minimum Stairway Width

1.5.5.1 General

Every escape stairway should be wide enough to accommodate the number of persons needing to use it in an emergency. This will depend on the number of stairways provided and whether the escape strategy is based on the total or phased evacuation of the building (or part of the building).

Escape based on total (simultaneous) evacuation should be used for:

- (a) all stairs serving basements; or
- (b) all stairs serving buildings with open spatial planning; or
- (c) all stairs serving residential (care facility) buildings (Purpose Group 2 (a)(ii)) or residential (other) buildings (Purpose Group 2 (b)); or
- (d) all stairs serving assembly and recreation buildings (Purpose Group 5); or
- (e) all stairs serving shopping centres (Purpose Group 4(b)) (see [Subsection 1.7](#)).

[Paragraph 1.5.5.3](#) deals with the concept of total evacuation. [Table 8](#) assumes total evacuation of all storeys simultaneously, and may be used for all buildings.

[Paragraph 1.5.5.4](#) deals with the concept of phased evacuation, and sets out the special measures that are necessary if a system of phased evacuation is used. [Table 9](#) assumes the phased evacuation of not more than two floors at a time, and may be used for any buildings except those identified in the (a) to (e) above as needing to be designed on the basis of total evacuation.

1.5.5.2 Discounting of Stairways

Whichever method of evacuation (total or phased) is used, where two or more stairways are designed as an escape route (whether it is a protected stairs or an open stair – see [Para 1.4.3.10](#)), excluding buildings containing flats, it should be assumed that one of them might not be available due to fire or smoke. It is therefore necessary to discount each stairway in turn in order to ensure that the capacity of the remaining stairways is adequate for the number of persons needing to escape, unless they comply with [Para 1.5.5.2.2](#).

For buildings listed under [Para 1.5.5.2.1](#), discounting must always be applied.

This discounting requirement applies to a building irrespective of the provision of a sprinkler system (see [Section 8](#)).

As with the design of horizontal escape routes, where the maximum number of people needing to use the escape stairway is not known, the appropriate capacity should be calculated on the basis of the occupant capacity. Guidance on calculating occupant capacity is set out in [Para 1.3.1](#) and [Table 2](#) of this Technical Guidance Document.

Section 1: Means of Warning and Escape in Case of Fire

1.5.5.2.1 Buildings Where Stairways Must Be Discounted

Each stairway must be discounted in turn in any of the following cases:

- (a) assembly and recreation (Purpose Group 5 (a) and (b)) buildings; or
- (b) any building where, by virtue of the limits on travel distance and/or numbers of occupants, only two stairways are required; or
- (c) any building with a storey more than 20 m above ground level, except a building used as an office (Purpose Group 3), or a shop (Purpose Group 4(a)).

1.5.5.2.2 Situations Where Discounting Is Not Required

Excluding buildings listed in Para 1.5.5.2.1 above, stairways are not required to be discounted in turn if:

- (a) every escape stairway is approached on each storey through a protected lobby / protected corridor. In such a case the likelihood of a stairway not being available is significantly reduced and it is not necessary to discount a stairway. A protected lobby need not be provided on the topmost storey; or
- (b) the stairways are protected by a suitable pressurization system (a design method for pressurization of escape routes is set out in I.S. EN 12101-6); or
- (c) the part of the building that the stairway serves only contains flats (Purpose Group 1(c)); or
- (d) the stairway is a single escape stairway which conforms to [Para 1.5.3](#).

Discounting of storey exits still needs to take place, except in the part of a building containing flats.

1.5.5.3 Total / Simultaneous Evacuation

In a building designed for total evacuation, the escape stairways should have the capacity to allow all floors to be evacuated simultaneously.

[Table 8](#) gives capacities, based on total evacuation, for stairways of different widths (1m to 1.8 m) and numbers of storeys served (1 to 10).

Either formula below may be used as an alternative to [Table 8](#) or for more than 10 storeys, where the stair width is greater than 1.1 m.

$$P = 200w + 50(W - 0.3) (N - 1); \text{ or}$$

$$W = (P + 15N - 15) / (150 + 50N).$$

Section 1: Means of Warning and Escape In Case of Fire

Where:

P is the number of people that can be accommodated;

W is the width of the stairway in metres, and

N is the number of storeys served.

Separate calculations should be made for stairs serving basement storeys and stairs serving upper storeys.

The population, P, should be divided by the number of available stairs, after discounting.

The formula is useful to determine the width of stairs where people are not distributed evenly — either within a storey or between storeys.

The widths of stairways provided should also meet the criteria indicated at [Para 1.5.4](#) and take account of the need, where required, to discount any one stairway (see [Para 1.5.5.2](#)).

Table 8 Capacities of Stairways (Total Evacuation)										Para 1.5.5.3
Number of storeys served	Maximum number of persons accommodated on one stair of width:									
	1.0 m	1.1 m	1.2 m	1.3 m	1.4 m	1.5 m	1.6 m	1.7 m	1.8 m	
1	150	220	240	260	280	300	320	340	360	
2	190	260	285	310	335	360	385	410	435	
3	230	300	330	360	390	420	450	480	510	
4	270	340	375	410	445	480	515	550	585	
5	310	380	420	460	500	540	580	620	660	
6	350	420	465	510	555	600	645	690	735	
7	390	460	510	560	610	660	710	760	810	
8	430	500	555	610	665	720	775	830	885	
9	470	540	600	660	720	780	840	900	960	
10	510	580	645	710	775	840	905	970	1035	

Note:

- (1) The capacity of stairs serving more than 10 floors may be obtained by the formula at [Para 1.5.5.3](#).
- (2) See [Table 7](#) for minimum width of escape stairways.
- (3) For buildings with a topmost floor height > 30m, the maximum stair width is 1.4 m.

Section 1: Means of Warning and Escape in Case of Fire

1.5.5.4 Phased Evacuation

Phased evacuation may be considered for certain buildings, excluding those outlined in [Para 1.5.5.1](#).

The concept of phased evacuation is based on evacuating persons on a sequential basis, commencing with those on the storeys most affected by the fire in its initial stages. That is the storey on which the fire originates and the one immediately above.

By designing on the basis of phased evacuation, stairway widths less than those needed for total evacuation are possible. However, for stairways in such buildings, all of the following provisions should be met:

- (a) The stairways should be approached through a protected lobby or protected corridor at each storey except for a top storey consisting exclusively of plant rooms.
- (b) Every floor should be a compartment floor.
- (c) If the building has a storey with a floor over 30 m above ground level, the building should be protected throughout by an automatic sprinkler system (see [Section 8](#)).
- (d) The building should be fitted with an appropriate fire detection and alarm system to a minimum Category L2/L3 standard (see [Para 1.9.13](#)).
- (e) An internal speech communication system should provide communication between a control point at fire and rescue service access level and a defined point communication point on all storeys.

The minimum width of stairway designed on the basis of phased evacuation is indicated in [Table 9](#).

Table 9 Minimum Aggregate Width of Stairways for Phased Evacuation		Para 1.5.5.4
Maximum number of persons in any storey	Stairway width (m)	
100	1.0	
120	1.1	
130	1.2	
140	1.3	
150	1.4	
160	1.5	
170	1.6	
180	1.7	
190	1.8	

Notes:

- (1) As an alternative to using [Table 9](#), where the maximum number of persons in any one storey exceeds 100, the minimum width of a stairway may be calculated using $((P \times 10) - 0.1)$ m.
P = the number of people on the most heavily occupied floor.
- (2) See [Table 7](#) for minimum width of escape stairways.
- (3) See [Para 1.5.5.4 \(c\)](#) if the stairway serves any storey more than 30 m above ground.
- (4) This table assumes a phased evacuation of not more than two floors at a time.

1.5.6 Protection of Escape Stairways

1.5.6.1 General

Escape stairways need to have a satisfactory standard of fire protection if they are to fulfil their role as areas of relative safety during a fire evacuation. Protection of escape stairways is provided by enclosure of the stairway by fire-resisting construction. Certain situations (see [Para 1.5.8](#)) require the additional protection provided by a protected access lobby or corridor to the stairway.

In limited circumstances as set out in this document, such as from a gallery or a raised storage area (see [Para 1.4.3.10](#)), an open stairway may form part of an escape route. Such a stairway is not considered to be a protected stairway, and subject to the provisions set out in this document, does not need to be enclosed in fire-resisting construction.

Escape stairways should conform to the provisions in Paras 1.5.6.2 to 1.5.6.8 below.

Requirements for ventilation of stairways are specified under [Section 6](#).

1.5.6.2 Enclosure of Escape Stairways

Every escape stairway, unless it is an external escape stairway (see [Para 1.5.9](#)), or unless the stairway is permitted to be an open escape stairway, as set out in this document, should be situated within a fire-resisting enclosure (i.e. it should be a protected stairway).

There may be additional provisions if the stairway is also a protected shaft (where it penetrates one or more compartment floors (see [Section 3](#)) or if it is a fire-fighting stairway (see [Section 5](#)).

The performance requirements for the enclosure to a protected stairway are specified in [Appendix A \(Table 31 and Table 32\)](#).

The performance requirements for doors to the enclosure to a protected stairway are contained in [Appendix B \(Table 36\)](#).

1.5.6.3 Exits from Protected Stairways

Every protected stairway should discharge:

- (a) directly to a final exit; or
- (b) by way of a protected exit passageway to a final exit. The passageway should have the same standard of fire resistance, and the same standard of fire protection, e.g. provision of lobbies, as the stairway it serves.

1.5.6.4 Separation of Adjoining Stairways

Where two protected stairways (or exit passageways leading to different final exits) are adjacent, they should be separated by an imperforate enclosure.

Section 1: Means of Warning and Escape in Case of Fire

1.5.6.5 Use of Space within Protected Stairways

A protected stairway needs to be relatively free of potential sources of fire. However, the following may be included in the area formed by fire-resisting construction enclosing a protected stairway:

- (a) a refuge area which conforms to [Para 1.9.14](#); or
- (b) sanitary accommodation or washrooms, provided that the accommodation is not used as a cloakroom; or
- (c) a lift that satisfies the provisions for lifts in [Para 1.9.9](#); or
- (d) cupboards (which incorporate electrical apparatus) that are fire resisting and accessed via fire doors, or
- (e) a reception or enquiry area at ground or access level if:
 - (i) every floor served by such a protected stairway is provided with access to an independent means of escape (i.e. an alternative stairway); and
 - (ii) The reception or enquiry area should not be more than 10 m² in area.

Fixed battery-storage systems should not be installed anywhere within the area enclosed by fire-resisting construction forming a protected stairway, or in any room accessed directly from a protected stairway.

1.5.6.6 Fire Resistance and Openings in External Walls of Protected Stairways

Where a protected stairway projects beyond, or is recessed from, or is in an internal angle of, the adjoining external wall of the building, then the distance between any unprotected area in the external enclosures to the building and any unprotected area in the enclosure to the stairway should be at least 1.8 m (see [Diagram 15](#)).

Further provisions relating to the protection of escape stairways in a residential (care facility) building (Purpose Group 2(a)(ii)) are contained in [Section 3](#).

1.5.6.7 Gas or Liquid Fuel Pipes in Protected Stairways

Pipes intended to carry gaseous or liquid fuels, and associated equipment, should not be incorporated within a protected stairway.

1.5.6.8 Separation of Places of Special Fire Risk

Escape stairways require a high degree of protection from fire. Rooms or other accommodation which have doors opening onto escape stairways can threaten the escape routes from a building.

Places of special fire risk (see [Subsection 0.10](#)) should therefore be located so that they do not communicate directly with the enclosure to a protected stairway.

A lobby should be provided between the place of special fire risk and the stairway, to give adequate protection. Such a lobby should be ventilated in accordance with [Para 6.2.2](#).

1.5.7 Basement Stairways

Because of their situation, basement stairways are more likely to be filled with smoke and heat than are stairways in ground and upper storeys. Special measures are therefore needed in order to prevent a basement fire causing a hazard to upper storeys. These are set out in the paragraphs below. For basement stairways in shopping centres, see [Para 1.7.4](#).

1.5.7.1 Single Stairway

If any upper storey of a building (or part of a building) is served by a single escape stairway, then that stairway should not be continued down to serve any basement storey.

Any escape stairway between a basement and the ground storey should be separated, at ground level by a protected lobby or protected corridor from the stairway serving the upper storeys.

1.5.7.2 More than one Stairway

1.5.7.2.1 Certain Assembly and Recreation buildings

Not more than 50 % of the protected stairways serving the upper storeys or tiers of seating in an assembly and recreation building should continue down to basement level. Any stairs, which connect with basement levels, should be separated from each basement level by a protected lobby. The provisions of this paragraph apply to the following types of assembly and recreation buildings:

- (a) a theatre, public library, hall or other building of public resort used for social or recreational purposes; or
- (b) a place of public worship; or
- (c) a terminus, station or other facility for air, rail, road or sea travel; or
- (d) Any other assembly building not listed under Para 1.5.7.2.2 (a) or (b).

1.5.7.2.2 All other uses

If there is more than one escape stairway from an upper storey of a building (or part of a building), only one of the stairways serving the upper storeys of the building (or part) need be terminated at ground level. Other escape stairways may connect with the basement storey(s) if they are separated at each basement level by a protected lobby or protected corridor.

This provision also applies to the following types of assembly and recreation buildings:

- (a) a public house, restaurant or similar premises used for the sale to members of the public of food or drink for consumption on the premises.
- (b) a non-residential school or other educational establishment.

Diagram 15 External Protection to Protected Stairway

Para 1.5.6.6

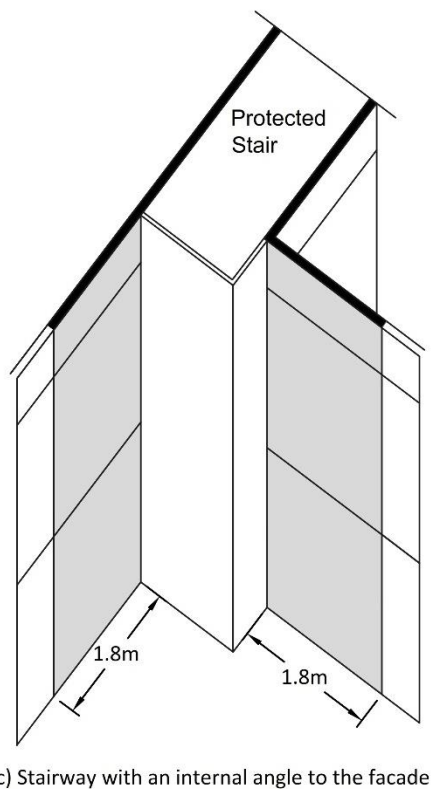
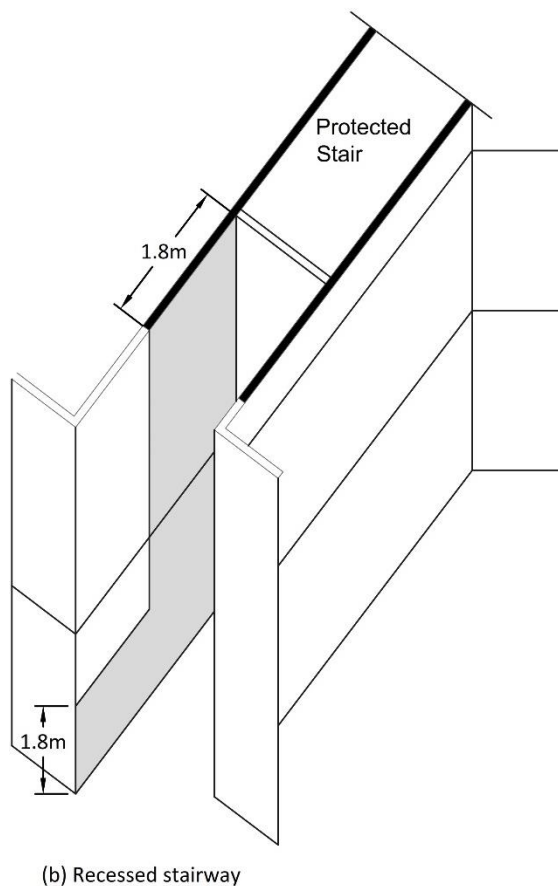
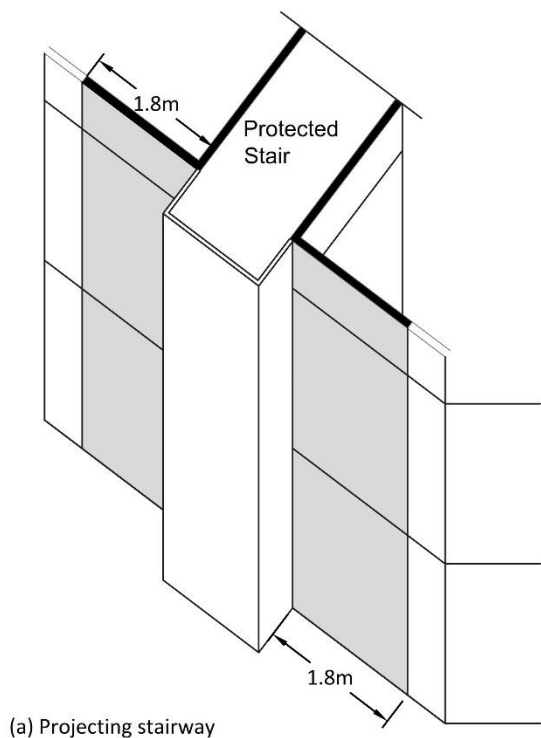

KEY



Fire resisting construction

Note:

- (1) The distance between any unprotected area in the external enclosure to the building and any unprotected area in the enclosure to the protected stair should be at least 1.8 m (see [Para 1.5.6.6](#)).
- (2) Where an external escape route from a final exit to a place of safety is within 1.8 m of the building, the associated external wall should be fire resisting to 1.8 m above the level of the escape route (see [Para 1.9.7](#)).
- (3) For provision of fire resisting construction, see [Appendix A](#)

1.5.8 Protected Lobbies and Corridors to Escape Stairways

1.5.8.1 Provision of Protected Lobbies and Corridors

There are situations where an escape stairway requires the added protection of a protected lobby or corridor. Except at the top-most level, access to a protected stairway in buildings other than a building containing flats (provisions for buildings containing flats are contained in Subsection 1.6.) should be by way of protected lobbies or protected corridors at all storey levels. This applies in any of the following cases:

- (a) In a single stairway building of three or more stories (see Appendix C, [Diagram 89](#)), except in the case in a small guesthouse (see [Para 1.5.8.2](#)); or
- (b) To any stairway where the stairway serves any storey at a height greater than 20 m (see Appendix C, [Diagram 91](#)); or
- (c) To any stairway where the building is designed for phased evacuation (see [Para 1.5.5.4](#)); or
- (d) Between a protected stairway and a place of special fire risk (see [Subsection 0.10](#)); or
- (e) In a building where no stairway has been discounted (see [Para 1.5.5.2.2 \(a\)](#)); or
- (f) Stairways that serve different purpose groups (see [Para 1.5.2.2](#)); or
- (g) To an external stairway, where an external stairs forms part of an escape route, and a suitable refuge area is not provided by the external stairs (see [Para 1.9.14.1](#), [Diagram 41](#)).

1.5.8.2 Small Guesthouses (Purpose Group 2(b)) (Part)

An exception to the requirement for a protected lobby or corridor to the stairway in a building served by a single escape stairway may be made in the case of a guest house (Purpose Group 2(b)) (part), where all the following conditions are met:

- (a) The guest house does not contain a basement and there are not more than three storeys (see Appendix C - [Diagram 89](#)); and
- (b) There are not more than four bedrooms on any upper storey; and
- (c) The stairway is a protected stairway (see [Para 1.5.6](#)); and
- (d) A fire detection and alarm system is provided in accordance with the requirements of [Para 1.9.13.3.2](#); and
- (e) All habitable rooms are provided with windows which can be used for escape or rescue (see [Para 1.6.4](#)).

Section 1: Means of Warning and Escape in Case of Fire

1.5.8.3 Requirements for Protected Lobbies and Corridors

Every protected lobby or corridor which is required to be provided should conform to the following:

- (a) Be constructed with walls having fire resistance as required in Section 3 for the protecting enclosure of the stairway, as per Appendix A, [Table 31, Item 14](#). Any door to the lobby should be a self-closing fire door having a fire resistance not less than half that required for the wall, but not less than 30 minutes.
- (b) Be constructed so that the clearance between the edges of the doors should be:
 - (i) when in the fully open position is not less than 0.5 m (Diagram 16 “A”); or
 - (ii) when in the closed position is not less than 1.0 m (Diagram 16 “B”);
 - (iii) or when the distance between any two doors in the closed position is less than 1.0 m, the planes of such doors are at an angle to one another of not less than 90 degrees (Diagram 16 “C”).
- (c) Where a lobby leads to a refuge, or a final exit, the minimum distance between doors ([Diagram 16](#) “A” or “C”) should be increased to 1.57 m (For further guidance, see Technical Guidance Document M (Access and Use)).
- (d) Be ventilated, if required, in accordance with [Para 6.2.2](#).

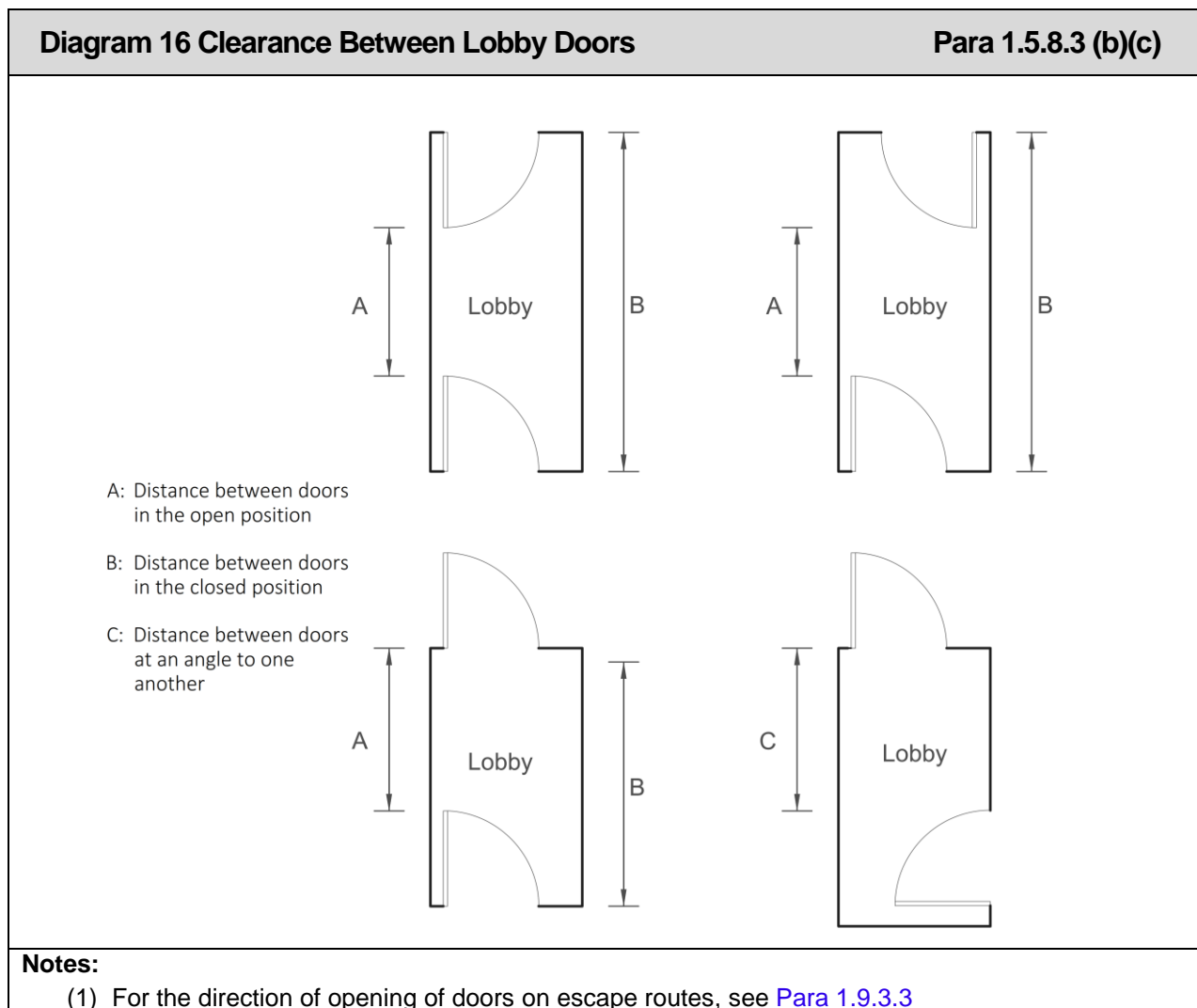

1.5.9 External Escape Stairways

In limited situations (see [Para 1.4.6](#)), external stairways are acceptable as forming part of an escape route. It is important that the external stairway is sufficiently protected from a fire in the building, and in certain circumstances is adequately protected from weather.

An external escape stairway should satisfy the following:

- (a) The stairway should not serve a storey more than 11m above ground level; and
- (b) Any part of the external walls identified below should be of fire-resisting construction:
 - (i) Within 1.8 m of, and 9 m vertically below, the flights and landings of a stairway leading downwards; or
 - (ii) Within 1.8 m of, and vertically above, the flights and landings of a stairway leading upwards; or
 - (iii) Within 3 m of the escape route from the foot of the stairway at ground level to a place of safety; and
- (c) All doors affording access to the stairway should be fire resisting, except that a fire-resisting door is not required at the head of any stairway leading downwards and where there is only one exit from the building onto the top landing; and
- (d) Stairways serving floors above 6 m above the external ground level should be protected from the effects of snow and ice. The degree of protection required will depend on the location of the stairway, proximity of adjacent buildings, and the protection that might be afforded to the stairway by the building itself. Such protection may include canopies and / or weather screens.

Unprotected openings should not be located in areas identified in (b) (i) – (iii) above, excluding a fire-resisting door is not required at the head of any stairway leading downwards (see (c) above). Any doors should be fire resisting, and windows should be fire resisting and fixed shut.

The construction of external escape stairways should comply with the requirements outlined in [Para 1.9.4](#). [Diagram 17](#) shows two examples of unprotected external escape stairways.

For requirements of refuges on external stairways, see [Para 1.9.14](#).

Section 1: Means of Warning and Escape in Case of Fire

Diagram 17 External Escape Stairways

Para 1.5.9

EXAMPLE A

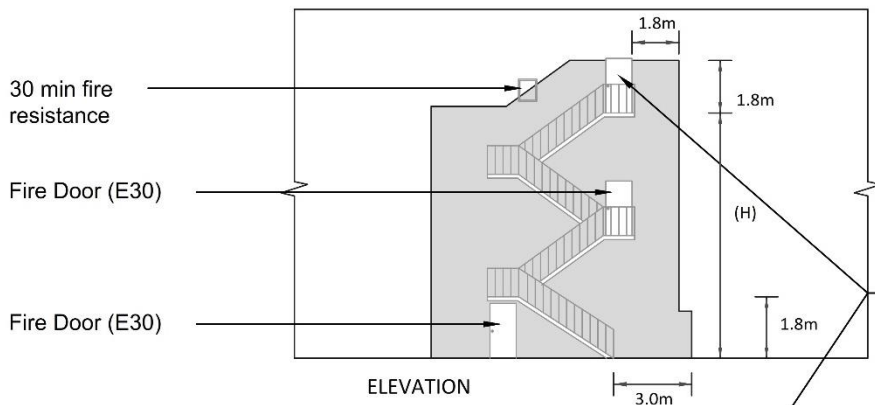

Additional provisions may apply where a refuge area is provided on an external escape stair.

EXAMPLE B

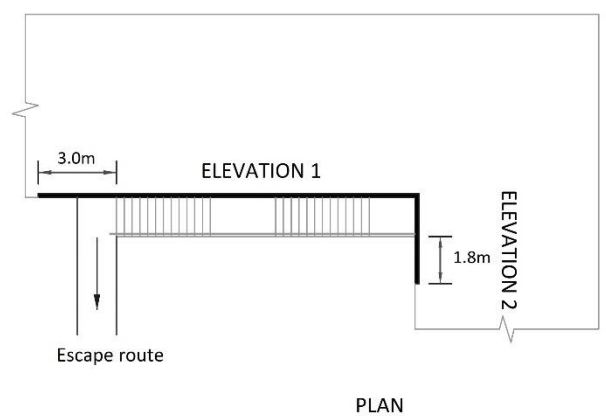
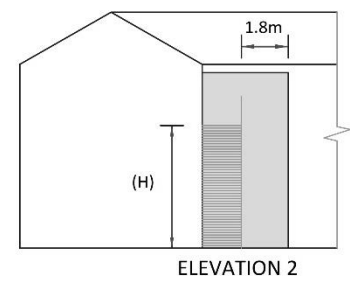
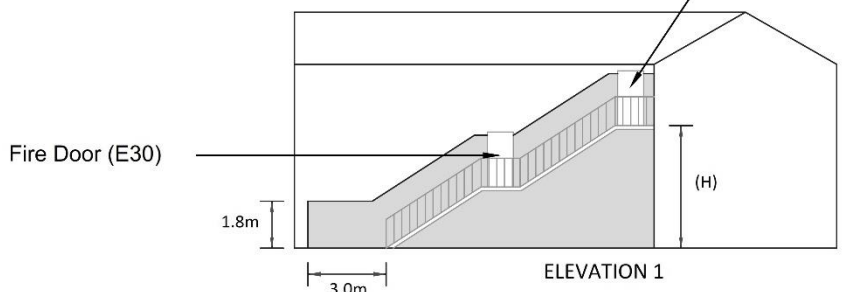

KEY
 Zone of fire-resisting construction

Notes:

- (1) Heights (H): 6 m (max) where no weather protection is provided; 11 m (max) where weather protection is provided (see [Para 1.5.9 \(c\)](#)).
- (2) Additional provisions may apply where a refuge area (see [Para 1.9.14](#)) is provided on the landing of an external escape stair.
- (3) For provision of fire resisting construction, see [Appendix A](#).
- (4) For provision of fire doors, see [Appendix B](#).

Section 1: Means of Warning and Escape In Case of Fire

1.6 Means of Escape from Flats (Purpose Group 1 (c))

1.6.1 Introduction

Guidance on the provision of means of escape (both horizontal and vertical) in buildings containing flats (Purpose Group 1(c)), is contained in this section.

There are two distinct components to planning means of escape from buildings containing flats:

- (a) escape within the flat; and
- (b) escape within the common parts of the building (corridors and stairways) that leads to a place of safety.

For sprinkler systems in buildings containing flats, see [Section 8](#).

1.6.1.1 Design Principles

The provisions in this section make the following assumptions:

- (a) That when a fire occurs within a flat, given the materials and construction used in common parts of the building, fire spread beyond the immediate vicinity of outbreak should not occur.
- (b) The design of escape from the flat should not be dependent on external rescue by fire services.
- (c) Simultaneous evacuation of flats in the event of fire is the default position.
- (d) Occupants of flats are capable of independent self-evacuation, to a refuge or place of safety.

1.6.1.2 Application of This Section

Paragraphs 1.6.2 to 1.6.5 deal with the means of escape within each flat. Paragraphs 1.6.6 to 1.6.7 deal with the means of escape in common areas of the building, and Para 1.6.8 deals with common areas in mixed-use buildings.

1.6.2 Internal Planning of Flats

The provisions relating to adequate means of escape within a flat depend on

- (a) the height of the flat above ground level; and
- (b) whether the flat is an open-plan flat or a flat with a protected entrance hallway.

1.6.2.1 Flats with an Independent External Entrance at Ground or Access Level

Flats or maisonettes having an independent external entrance at ground or access level should be treated in the same way as those having corridor or lobby access.

Section 1: Means of Warning and Escape in Case of Fire

1.6.2.2 Flats with a Protected Entrance Hallway

Flat layouts with a protected entrance hallway can be used in all building types to which this section applies (small single-staircase buildings, lobby-, corridor- or open deck approach buildings, etc.) irrespective of the storey height of the flat. Normally, habitable rooms should not be inner rooms; however where the flat is located close to the ground, or where an alternative exit (see [Para 1.6.5](#)) is provided, then special rules can apply (see [Para 1.6.2.2.2](#) and [Para 1.6.2.2.3](#)).

1.6.2.2.1 General Provisions

The following provisions apply:

- (a) The maximum travel distance within the protected entrance hallway should be 9 m. This distance should be measured from:
 - (i) the door to the flat, to the entrance of any habitable room, where the flat is on a single level (see [Diagram 18 \(a\)](#)); or
 - (ii) the landing of the stairs, where the flat is accessed below the level to the flat (see [Diagram 18 \(b\)](#)).
- (b) The protected entrance hallway should have the appropriate fire resistance as specified in [Appendix A, Table 31](#) and [Table 32](#).
- (c) All doors forming part of the fire-resisting enclosure of the protected entrance hallway should be fire doors fitted with self-closers (a fire door to a hotpress does not need a self-closer), and have the appropriate fire resistance specified in [Appendix B](#).
- (d) The walls of the protected entrance hallway should:
 - (i) be carried to the underside of the structural floor, or roof above, and be appropriately fire-stopped; or
 - (ii) be carried to a ceiling which is not fire resisting, with cavity barriers placed in any void, along the lines of the protected entrance hallway, to limit the spread of smoke; or
 - (iii) be carried to a fire-resisting ceiling (see [Diagram 9\(c\)](#), [Diagram 42 \(b\)](#)), which extends throughout the compartment.
- (e) All habitable rooms should be accessed directly from the protected entrance hallway, unless they conform to the provisions of [Para 1.6.2.2.2](#), or [Para 1.6.2.2.3](#).
- (f) Any penetrations of the protected entrance hallway should be fire-stopped in accordance with [Subsection 3.7](#).
- (g) If the partitions between a bathroom and any adjacent room has a fire resistance equal to that of the protected entrance hallway walls, then the partition between the bathroom and the hall need not be fire resisting and the bathroom door need not be a fire door.

Section 1: Means of Warning and Escape In Case of Fire

1.6.2.2 Flats at Basement Level, or at a Level no More Than 4.5 m above Ground Level

Habitable rooms should not be inner rooms, unless the inner room is provided with a window (see [Para 1.6.4](#)), or a door (see [Para 1.6.5](#)) for escape or rescue purposes.

1.6.2.2.3 Flats Located at a Level More Than 4.5 m above Ground Level

Habitable rooms should not be inner rooms, unless the inner room is provided with a door (see [Para 1.6.5](#)) for escape purposes.

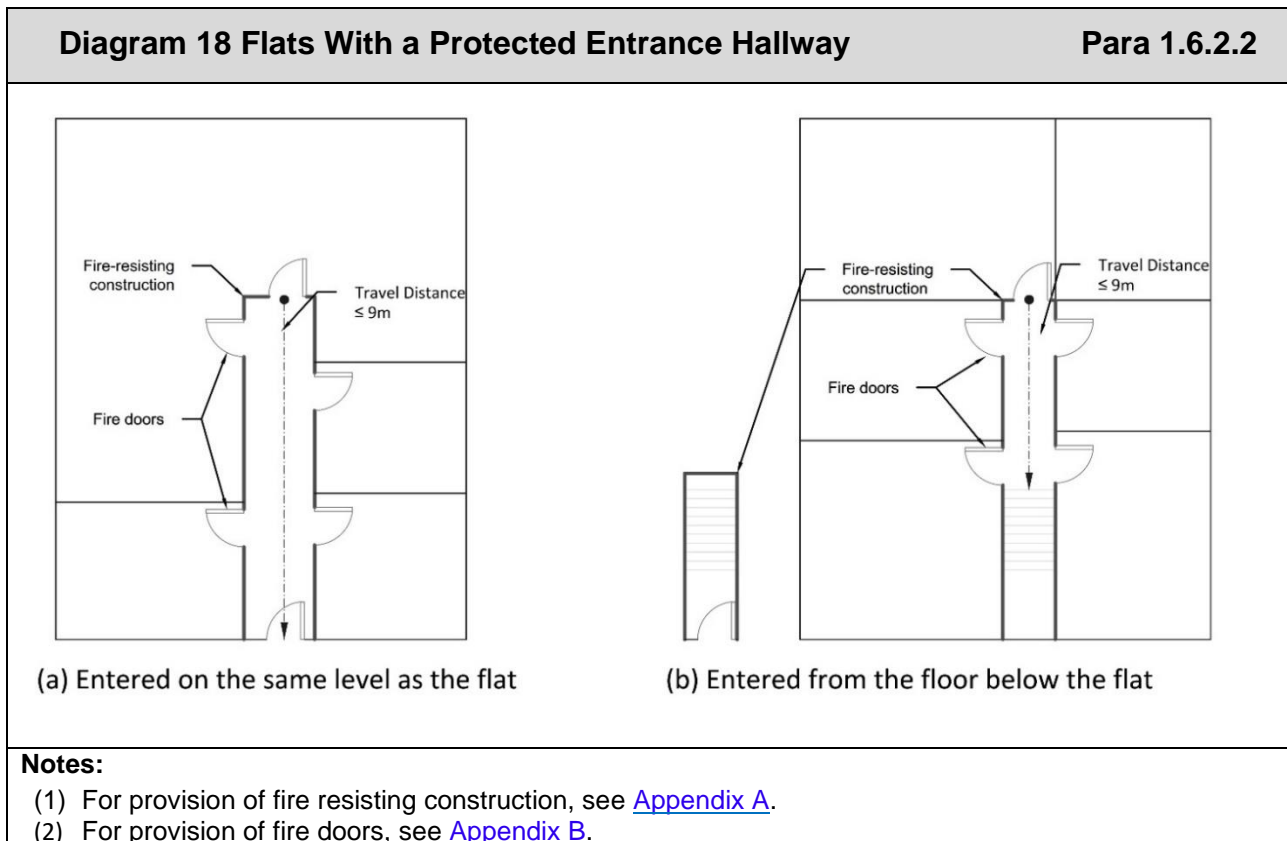

1.6.2.3 Open-Plan Flats

1.6.2.3.1 Introduction

This section provides means of escape provisions for open-plan flats (see Definitions, [Subsection 0.10](#)).

The provisions of Para 1.6.2.3 do not apply to small, single-staircase buildings (see [Para 1.6.6.1](#), [Diagram 25 \(b\)](#)) where a flat is accessed directly from the stairway, which relies upon the internal protected entrance hall for lobby protection to the staircase enclosure.

The means of escape requirements in open-plan flats are determined by the maximum travel distance within the flat.

Where the travel distance is less than or equal to 9 m, the provisions of [Para 1.6.2.3.3](#) apply.

Where the maximum travel distance is greater than 9 m, the provisions of [Para 1.6.2.3.4](#) or [Para 1.6.2.3.5](#) apply.

Section 1: Means of Warning and Escape in Case of Fire

An alternate means of escape from an open-plan flat (where required) can be either an escape window direct to the open air, or an alternate exit (door) leading to an exit route (corridor and stairs). The appropriate application of these two distinct alternate means of escape options depends on the height of the flat above ground level (see [Para 1.6.2.3.4](#), [Para 1.6.2.3.5](#), [Para 1.6.4](#) and [Para 1.6.5](#)). Escape windows are not appropriate as an alternate exit from open plan flats with a floor > 4.5 m above ground level.

1.6.2.3.2 General

Any door to an open-plan flat, from a common area, should have a fire resistance equal to the fire resistance of the wall, but not more than 60 minutes, in accordance with [Appendix B](#).

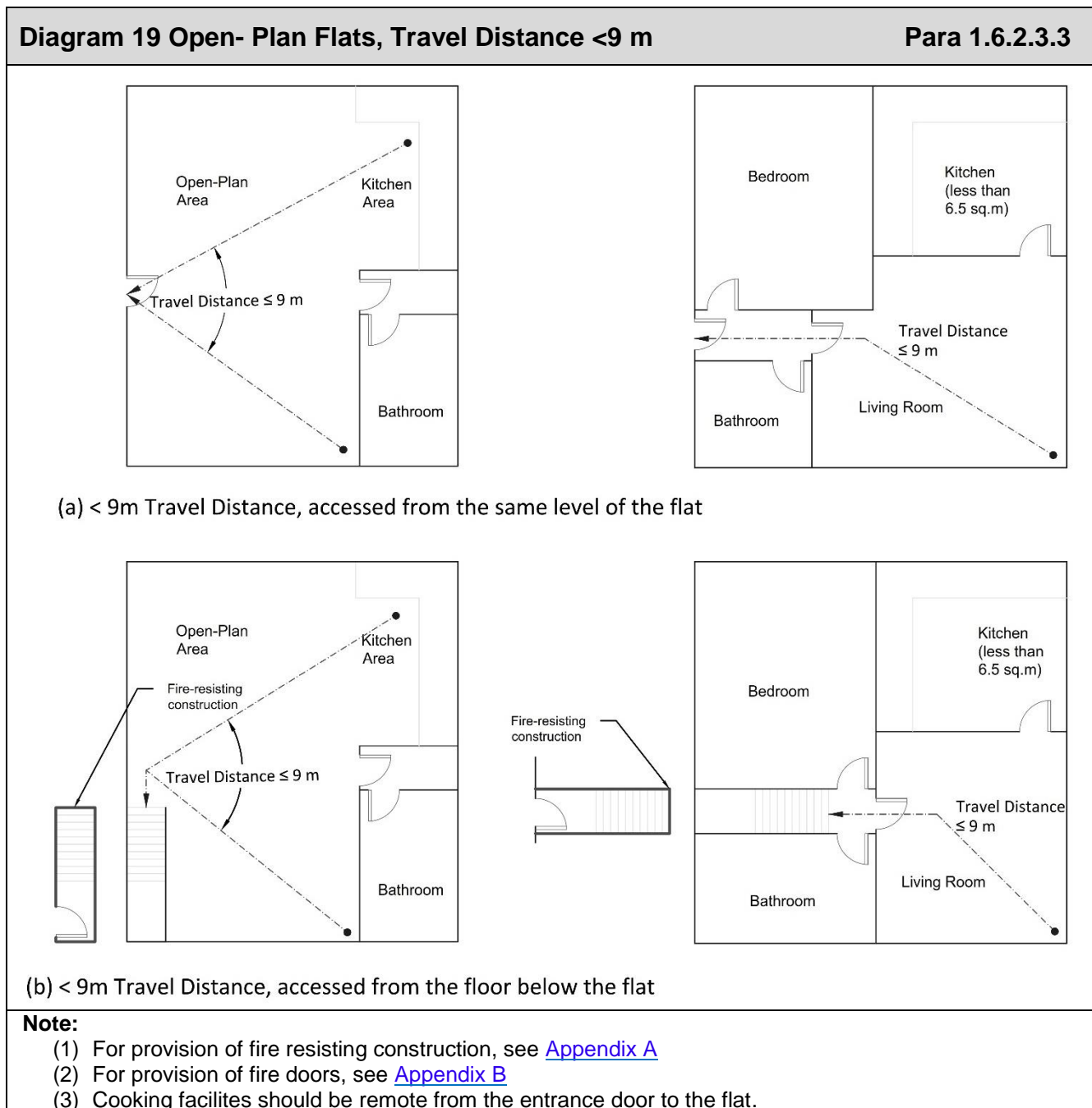

Section 1: Means of Warning and Escape In Case of Fire

1.6.2.3.3 Open-Plan Flats with a Travel Distance of Less Than 9 m

For open-plan flats of this type (see [Diagram 19](#)), the following provisions apply:

- (a) The flat should not be accessed from the floor above the flat.
- (b) Any kitchen main cooking appliance should be located remote from the door to the flat, and should not prejudice the escape route from the flat.
- (c) For open-plan flats located at basement level, or not more than 4.5 m above ground level, a habitable room should not be an inner room, unless the inner room is provided with a window (see [Para 1.6.4](#)), or a door (see [Para 1.6.5](#)) for escape or rescue purposes.
- (d) For flats located more than 4.5 m above ground level, a habitable room should not be an inner room, unless the inner room is provided with a door (see [Para 1.6.5](#)) for escape purposes.
- (e) Travel distance within the flat should be measured:
 - (i) from the door to the flat, to the deepest point of any habitable room, or
 - (ii) from the landing of the stairs, where the flat is accessed below the level to the flat.

1.6.2.3.4 Open-Plan Flats with a Travel Distance of More Than 9 m Located at Basement, Ground or < 4.5 m Above Ground Level

Where open-plan flats of this type are at basement level, or at not more than 4.5 m above ground level, any bedroom should be provided with a window (see [Para 1.6.4](#)), or a door (see [Para 1.6.5](#)) for escape or rescue purposes (see [Diagram 21](#)). Alternatively, the provisions in 1.6.2.3.5 may apply.

1.6.2.3.5 Open-Plan Flats with a Travel Distance of More Than 9 m located at any level

Where open-plan flats of this type are located at any level, and the provisions of Para 1.6.2.3.4 are not followed, the following provisions apply:

- (a) all habitable rooms should be provided with access to a corridor, which need not be a protected corridor. The corridor should provide access to both the main entrance to the flat, and an alternative exit from the flat, which should be remote from the main entrance to the flat (see [Diagram 21](#) (b)); or
- (b) the main kitchen / living area of the flat should be separated from the any bedrooms by a storey height subdivision which is fire resisting (see Appendix A), and which is accessed via a fire door (see Appendix B). Each bedroom should have access to a corridor which leads to an alternative exit (see [Diagram 21](#) (c)); or
- (c) each habitable room, which is an inner room, should be provided with a door that leads to an appropriate alternative exit (see [Diagram 21](#) (d)); or

Section 1: Means of Warning and Escape in Case of Fire

- (d) the flat should conform to the following (see [Diagram 20](#)):
- (i) the flat should have a sprinkler system in accordance with [Para 8.4.1](#); and
 - (ii) the flat should be situated on a single storey only; and
 - (iii) the travel distance from any point in the flat to the final exit from the flat should not exceed 20m; and
 - (iv) the kitchen should satisfy one of the following requirements:
 - I It should be enclosed in storey-height construction, which need not be fire resisting, or
 - II Alternatively, if the kitchen is not enclosed, the flat layout should be designed such that an occupant escaping the flat should not have to approach within 1.8 m of the kitchen's main cooking appliance.

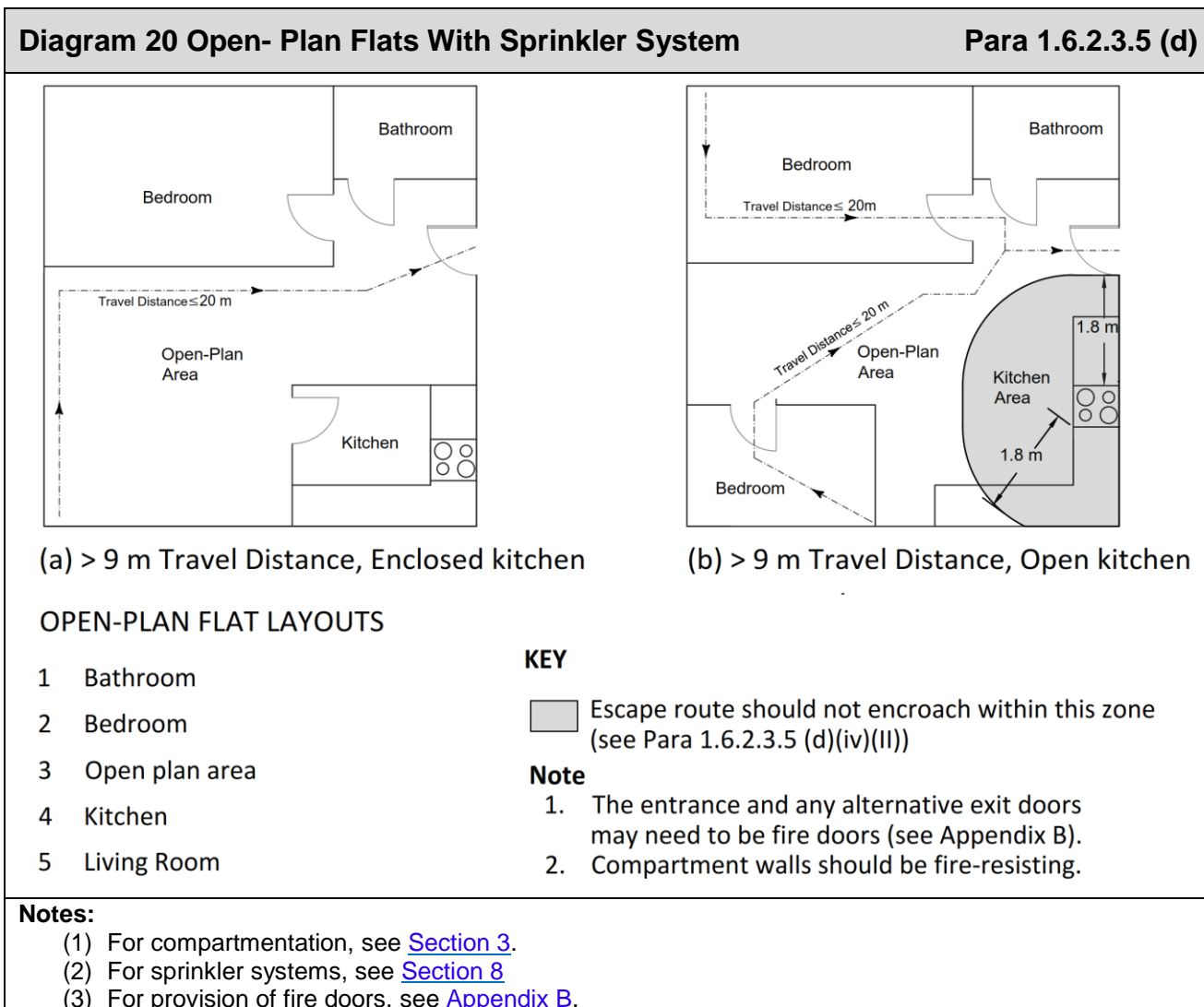
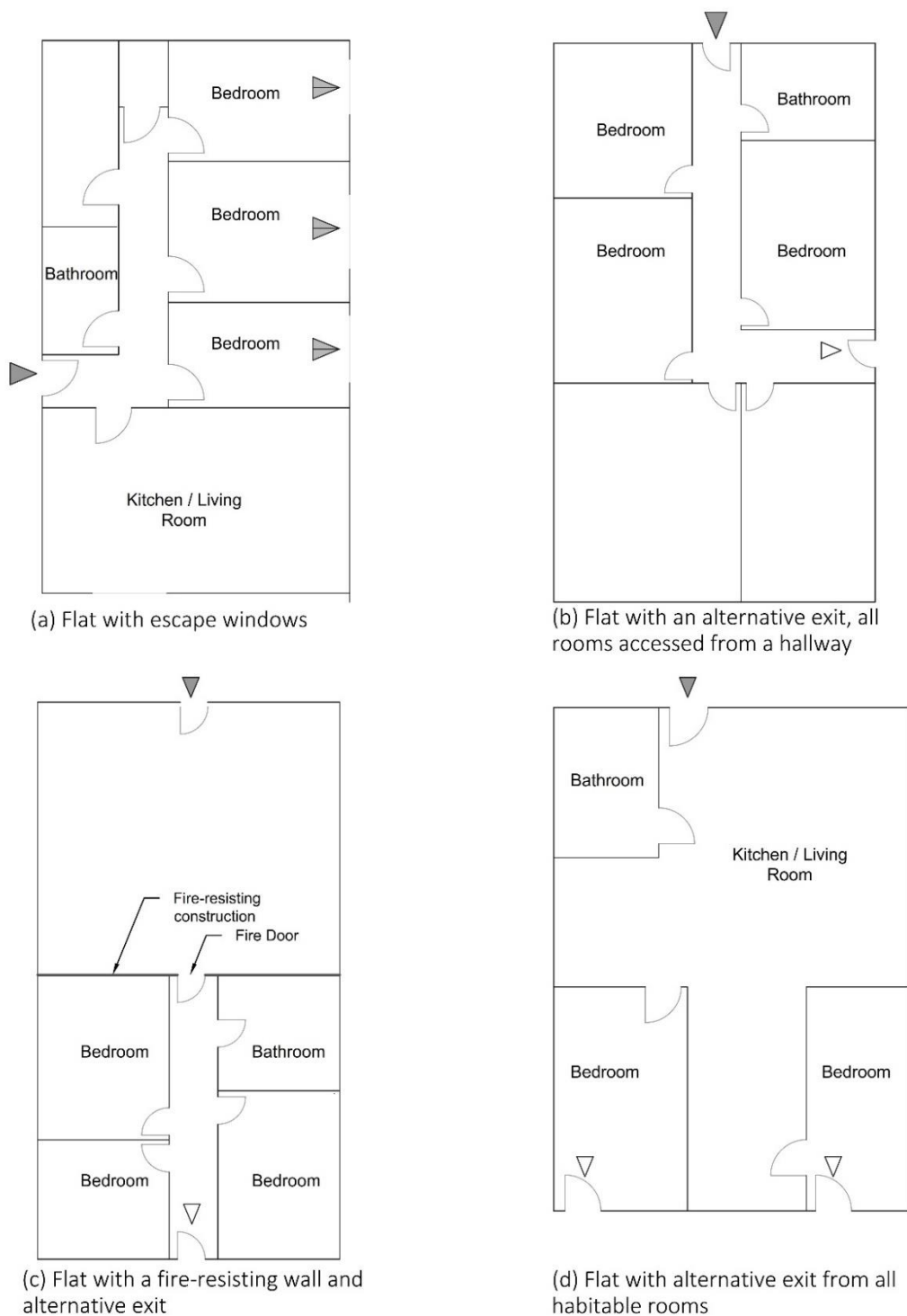

Diagram 21 Escape Windows / Alternative Exits From Open-Plan Flats

**Para 1.6.2.3.4,
Para 1.6.2.3.5(a - c)**



KEY

- ◀ Main entrance
- ◀ Escape window
- ◀ Alternative exit (door)

Notes:

- (1) For compartmentation see [Section 3](#).
- (1) For performance of fire-resisting walls, see [Appendix A](#).
- (2) For performance of fire-resisting doors, see [Appendix B](#).
- (3) An escape window, or alternative exit may be provided to flats with a floor level < 4.5 m above ground level (see [Para 1.6.4](#)).
- (4) An alternative exit (where required) should be a door leading to an escape route in flats with a floor level > 4.5 m above ground level (see [Para 1.6.5](#)).

Section 1: Means of Warning and Escape in Case of Fire

1.6.2.4 Provisions for Flats with Galleries

Galleries should only be provided in flats with a protected entrance hallway (see [Para 1.6.2.2](#)). A gallery provided with an appropriate alternative means of escape (see [Para 1.6.4](#) or [Para 1.6.5](#)) should be treated as an inner room and conform to (a) of (b) below. A gallery with no alternative means of escape should conform to (c) below.

- (a) For a gallery floor < 4.5 m above ground level, a window (see [Para 1.6.4](#)) or door (see [Para 1.6.5](#)) for escape or rescue should be provided from the gallery level; or
- (b) For a gallery floor > 4.5 m above ground level, a door (see [Para 1.6.5](#)) for escape or rescue should be provided from the gallery level; or
- (c) All of the following provisions (see [Diagram 22](#)) should be met:
 - (i) The main entrance and main floor of the flat should be at the same level; and
 - (ii) The gallery is not designed for use as a sleeping area; and
 - (iii) The gallery should not project into more than 50% of the area of the room below; and
 - (iv) The distance between the foot of the access stair to the gallery and the door to the room containing the gallery should not exceed 3 m; and
 - (v) The distance from the head of the access stair to any point on the gallery should not exceed 7.5 m; and
 - (vi) Any main cooking appliance within a room containing a gallery should meet one of the following provisions:
 - I They should be enclosed in storey-height construction, which need not be fire resisting; or
 - II the kitchen main cooking appliance should be situated not less than 3 m from the stair to the gallery and positioned such that it does not prejudice the escape from the gallery.

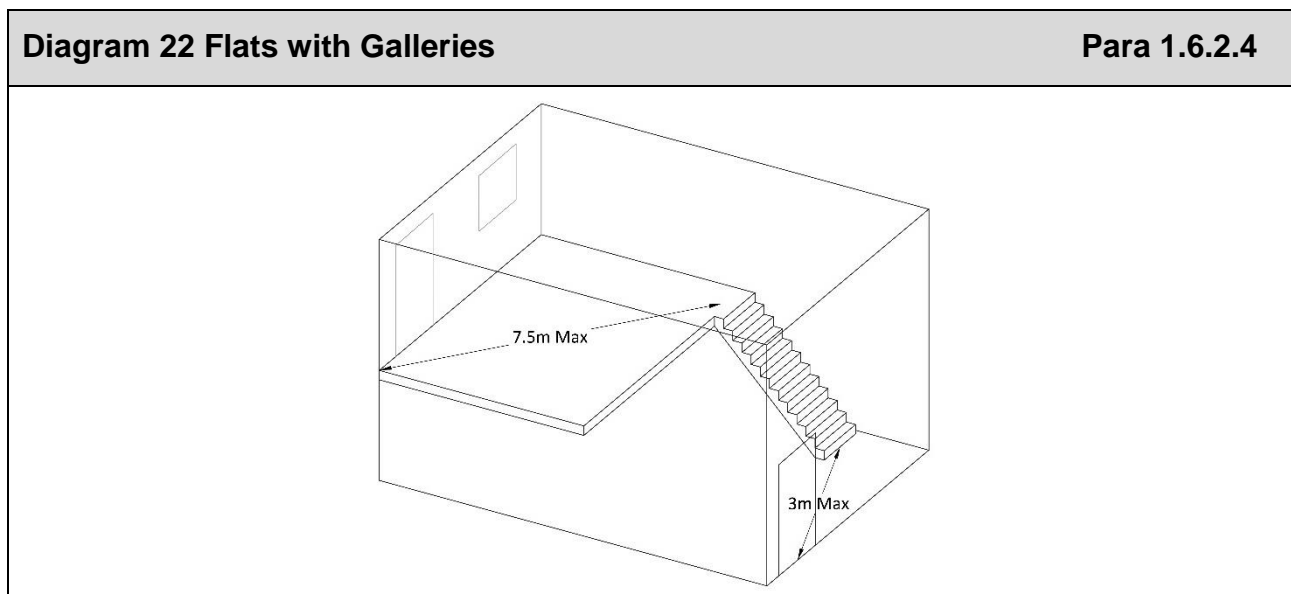

1.6.3 Maisonettes

A maisonette located at ground level, with accommodation at the ground and the first floor only (within the unit) will typically have no floor more than 4.5 m above ground level. Therefore, the provisions of [Para 1.6.3.1](#) are appropriate.

A maisonette accessed at any other level (e.g. external stairs, podium, corridor access), or with more than three storeys will typically have one or more floors within the unit at more than 4.5 m above ground level. Therefore the provisions of [Para 1.6.3.2](#) are appropriate.

1.6.3.1 Maisonettes with no Floors Situated More Than 4.5m above Ground Level

1.6.3.1.1 With an enclosed stair

This type of maisonette should conform to the following:

- (a) any habitable room which is an inner room should be provided with a window for escape or rescue in accordance with [Para 1.6.4](#); and
- (b) the stairway serving the upper storey should be enclosed with storey-height construction, which need not be fire-resisting, and should discharge to the main entrance to the maisonette (see [Diagram 23\(a\)](#)).

1.6.3.1.2 With an open stair

An open-plan arrangement, where the stairway rises directly from the ground storey accommodation is only acceptable where:

- (a) all habitable rooms at the upper storey are provided with windows for escape or rescue in accordance with [Para 1.6.4](#); and
- (b) the stairway discharges to within 4.5 m of a door (final exit) at the ground storey leading directly to the open air; and
- (c) the stairway does not discharge into a kitchen (see [Diagram 23\(b\)](#)) and either;
 - (i) any ground storey kitchen, where the main cooking appliance are within 3 m of the stairway is enclosed in storey height construction which need not be fire resisting (see [Diagram 23\(c\)](#)); or
 - (ii) where the stairway passes within 3 m of the main cooking appliance, the stairway should be shielded to the foot of the stairs with ceiling – height construction which need not be fire-resisting (see [Diagram 23\(d\)](#)).

1.6.3.2 Maisonettes with a Floor Situated More Than 4.5 m above Ground Level

The maisonette should be designed such that:

- (a) any habitable room is not an inner room.
- (b) All rooms in the maisonette should be accessed by a protected stairway (see [Diagram 24\(a\)](#)), which should have the appropriate fire resistance as specified in [Appendix A](#), [Table 31](#) and [Table 32](#).

Section 1: Means of Warning and Escape in Case of Fire

(c) All doors opening into the protected stairway enclosure should be fire doors (see [Appendix B](#)).

(d) Where any floor within the unit is more than 7.5m above the level of the entrance of the maisonette, a sprinkler system (see [Para 8.4.1](#)) should also be provided.

If the partitions between a bathroom and any adjacent room has a fire resistance equal to that of the protected stairway walls, then the partition between the bathroom and the hall need not be fire resisting and the bathroom door need not be a fire door.

Diagram 23 Maisonettes - No floor more than 4.5 m above ground level Para 1.6.3.1

Access level plan

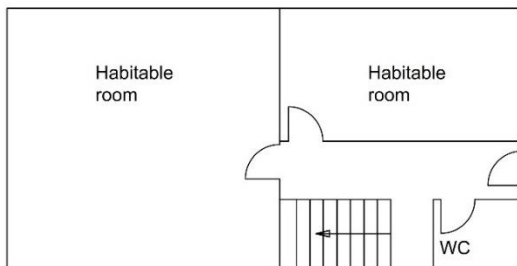

Upper level plan

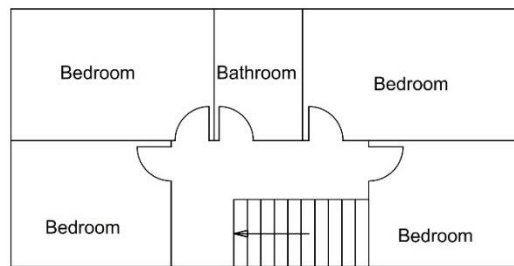

(a) < 4.5 m above ground level

Open-plan arrangements

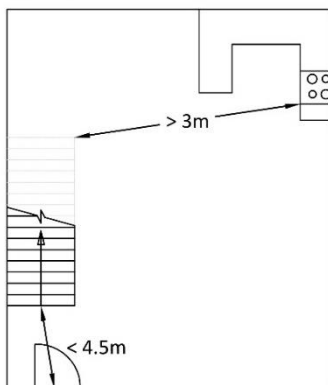

(b) Open plan arrangement for escape - stairway does not discharge into a kitchen

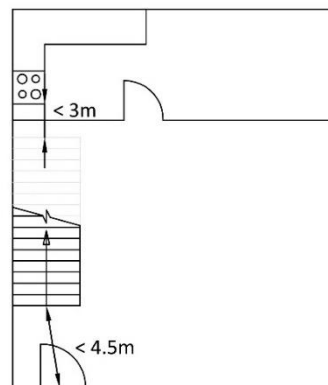

(c) Open plan arrangement for escape - kitchen is enclosed

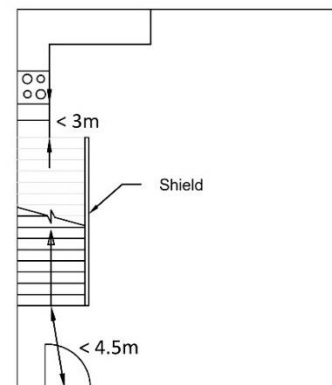

(d) Open plan arrangement for escape - shield to stairs

Section

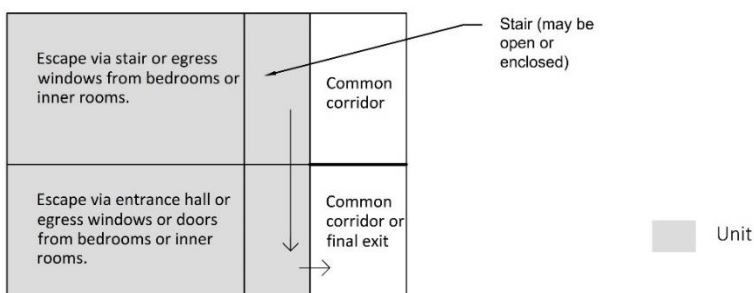

(e) Maisonette with each floor < 4.5 m above ground level

Note:

- (1) For provision of fire resisting construction, see [Appendix A](#).
- (2) For provision of compartmentation, see [Section 3](#).
- (3) For provision of fire doors, see [Appendix B](#).
- (4) Open plan arrangements apply only where there is no storey > 4.5m above ground level, and the main entrance door discharges directly to the open air (see [Para 1.6.3.1.2](#)).

Diagram 24 Maisonettes with any floor more than 4.5m above ground level

Para 1.6.3.2

Access level and upper level plan

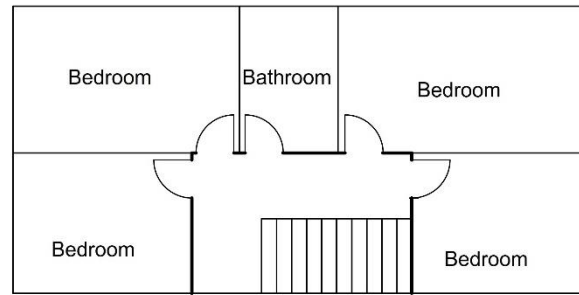
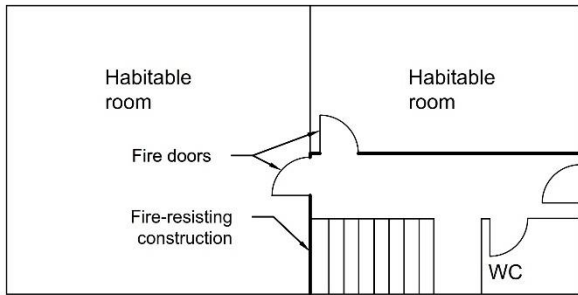

(a) > 4.5m above ground level

Means of escape from maisonettes with any floor more than 4.5m above ground level

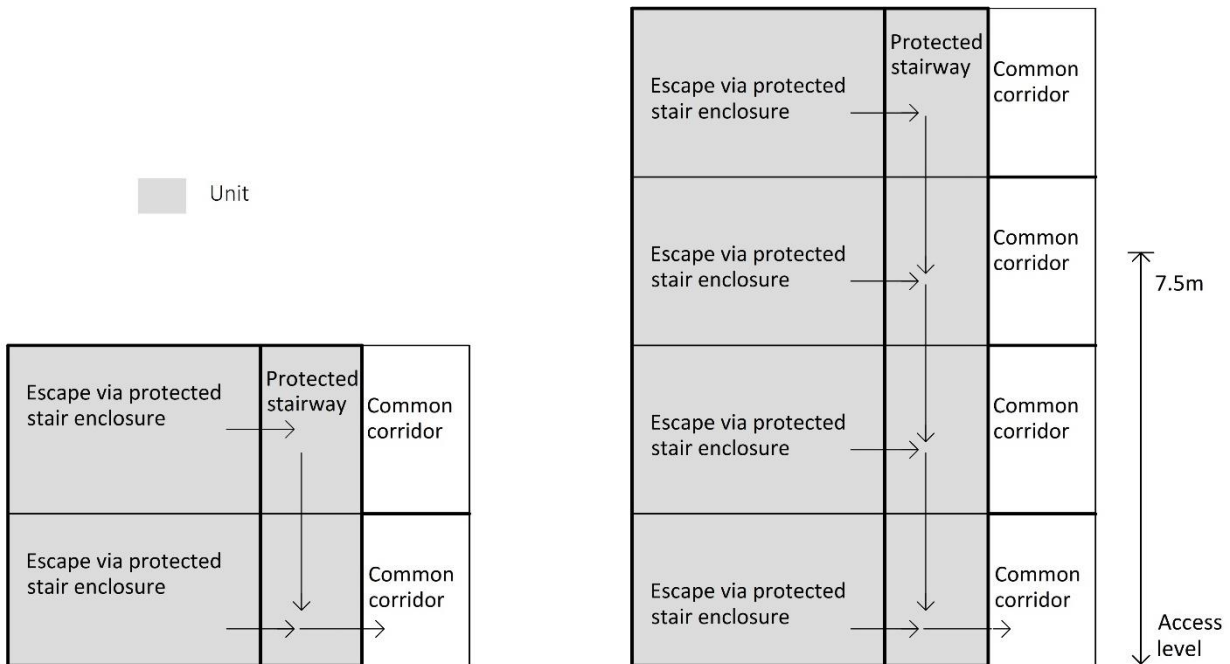

(b) Maisonette with any floor > 4.5 m above ground level

(c) Maisonette with any floor > 7.5 m above access level
Note: Sprinkler system required throughout maisonette

Note:

- (1) For provision of fire resisting construction, see [Appendix A](#).
- (2) For provision of compartmentation, see [Section 3](#) and [Appendix A](#).
- (3) For provision of fire doors, see [Appendix B](#).
- (4) Any doorset forming part of a fire resisting enclosure to an intermediate stairway in a maisonette should be a fire door.

Section 1: Means of Warning and Escape in Case of Fire

1.6.4 Escape Windows

Windows may provide an alternative means of escape or may be used for rescue purposes in flats of limited height.

As an alternative, a door which gives direct access to a private balcony which is suitable for rescue by ladder or for escape may be used.

For the design of escape windows, all of the following provisions should be met:

- (a) The window should have an openable section which provides an unobstructed clear open area of at least 0.33 m². The height should be not less than 450 mm. The width should be not less 450 mm. The opening section should be capable of remaining in the position which provides this minimum clear open area.
- (b) The bottom of the window opening should be not more than 1.1 m, and in the case of a rooflight not less than 600 mm above the floor, immediately inside or beneath the window or rooflight.
- (c) As an exception to the general guidance in TGD K that guarding be provided for any window the cill of which is less than 800 mm in height above floor level (where the external ground level is below 1.4 m below floor level), guarding should not be provided to a rooflight opening provided in compliance with this paragraph.
- (d) In the case of a dormer window or rooflight, the distance from the eaves to the bottom of the opening section of the rooflight, or, where the window is vertical, the vertical plane of the window should not exceed 1.7 m measured along the slope of the roof.
- (e) The area beneath the window externally should be such as to make escape or rescue practicable. For example:
 - (i) where there is a clear drop from a window in an upper storey, the ground beneath the window should be suitable for supporting a ladder safely and be accessible for rescue; and
 - (ii) where there is a roof, balcony or canopy below a window for escape or rescue, it should be structurally adequate, and have a fire resistance, to support and protect those using the window.
- (f) The opening section of the window should be secured by means of fastenings which are readily openable from the inside. In certain circumstances, safety restrictors may be fitted to such windows (see TGD K Subsection 2.7). Lockable handles or restrictors, which can only be released by removable keys or other tools, should not be fitted to window opening sections for escape or rescue.

1.6.5 Alternative Exits from Flats

Alternative exits from flats, where required for these purposes, should conform to the following:

- (a) Be sited away from the main entrance door to the dwelling such that it can still be used as an escape route (see [Diagram 21](#) (b), (c) and (d)).
- (b) Lead to a final exit or common stair:
 - (i) via a door leading onto an access corridor, common balcony or deck at the same or another level; or
 - (ii) via a protected stairway leading to an access corridor, common balcony or deck at another level; or
 - (iii) via a door leading onto an external stair or a protected stairway; or
 - (iv) via a door leading onto an escape route across a flat roof leading to the head of a common or external stair.

The internal arrangement of any dwelling having an alternative exit should be such that access is possible from all habitable rooms either to the main entrance or to a corridor leading to the alternative exit (see [Diagram 21](#) (b) and (c)).

1.6.6 Horizontal Means of Escape in Common Parts of Flats

As seen in [Subsection 1.4](#) and [Subsection 1.5](#), horizontal and vertical escape is dependent on the type of building (Purpose Group), on its capacity, on travel distance, and on its height. In buildings containing flats, because of the high degree of compartmentation, typically, one set of stairs is required. However, the provision of a single stairs will limit corridor travel distance, and will require additional provisions, as provided for in the following sections.

Means of escape in the common parts of flats can include an open deck approach or a common protected corridor/ lobby.

The following sections address means of escape from the entrance doors of a flat to a final exit.

The maximum travel distance in a building containing flats will depend on the topmost floor height of the building, the provision of a ventilation system and the number of stairs provided.

For buildings with a single stairs with a topmost floor level below 11m and no ventilation system, the provisions of [Para 1.6.6.1](#) should be met. For all other buildings, the provisions of [Para 1.6.6.2](#), or [Para 1.6.6.3](#) should be met. The minimum widths of escape routes should conform to [Table 5](#).

Diagram 25 Single Stair Buildings, topmost floor height ≤ 11 m

Para 1.6.6.1

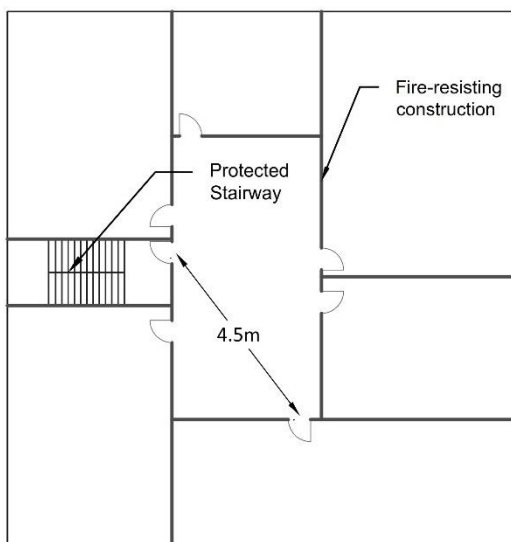

(a) Single stair building containing flats

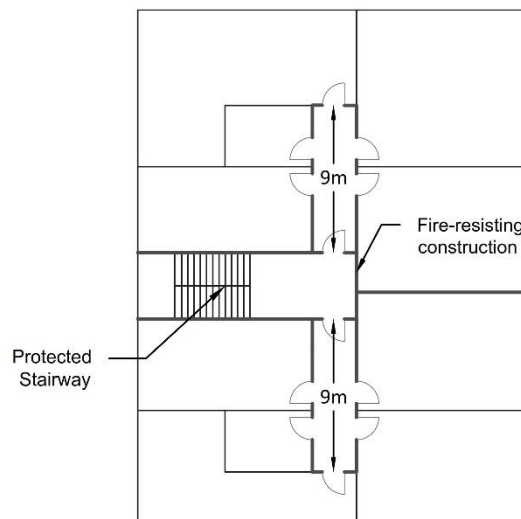

(b) Single stair building containing flats (1 - 2 flats per floor)

Notes:

- (1) Maximum storey height is ≤ 11 m / 4 storeys.
- (2) Where a ventilation system (see [Subsection 6.6](#)) is provided, the maximum travel distance may be increased to 7.5 m.
- (3) For provision of fire resisting construction, see [Appendix A](#).
- (4) For provision of compartmentation, see [Section 3](#) and [Appendix A](#).
- (5) For provision of fire doors, see [Appendix B](#).
- (6) For stairway ventilation, see [Subsection 6.2](#).

1.6.6.1 Small Single-Stair Buildings

A small single-stair building is a building which does not have a storey at a height greater than 11 m, and which has no more than four storeys above ground level. It has a single stair and, typically, no smoke control system to the common corridor / lobby. The following provisions apply in such a building:

- (a) The travel distance, measured from the door to the flat to the door to the stairway, should be no more than 4.5 m, which may be extended to 7.5 m if a smoke control system (see [Subsection 6.6](#)) is provided (see [Diagram 25\(a\)](#)); and
- (b) The stairway should discharge to:
 - (i) the open air at ground or access level, via a final exit; or
 - (ii) a protected corridor that leads directly to a final exit and is provided with the same protection from the accommodation as is provided to the stairway; and
- (c) A stairway may connect to a basement car park, if the access to the car park is separated from the stairway enclosure serving the flats, at ground level, by fire resisting construction (see [Diagram 26](#)) (see [Para 6.2.2](#)); and
- (d) Ancillary accommodation should be separated from the stairway or a single escape route by a protected lobby or corridor that is provided with permanent ventilation of not less than 0.4 m² for the control of smoke (see [Para 6.2.2](#)) or an equivalent mechanical smoke control system.

Section 1: Means of Warning and Escape In Case of Fire

Where there are no more than two flats on each floor, the flats may access the stairway directly, if the flat is provided with a protected entrance hallway, or a protected lobby, as appropriate (see [Diagram 25](#) (b)). Such a protected entrance hallway or protected lobby need not be provided if each flat has been provided with an appropriate alternative means of escape.

Diagram 26 Separation of Basement Stairs

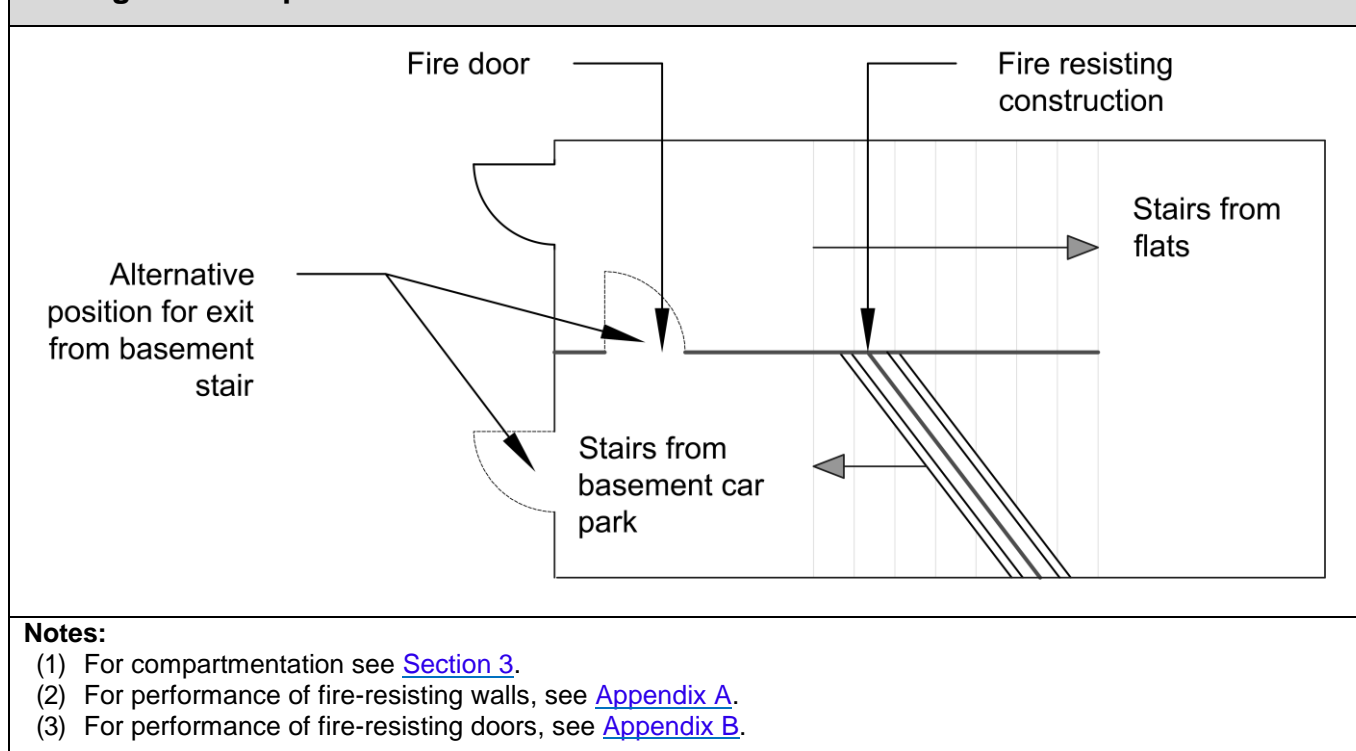

1.6.6.2 Buildings with a Common Open Deck Approach

An open deck is a common walkway where the area above any required balustrade is continuously open to the external air.

The following provisions apply to a building containing flats with an open deck approach (see [Diagram 27](#)):

- The floor forming the open deck should achieve 30-minute fire resistance (REI).
- The open deck should be imperforate. Any service penetration, e.g. drainage pipes should be adequately fire-stopped (see [Subsection 3.7](#)).
- The soffit of the open deck should be designed to direct smoke outwards and upwards. This may be facilitated by ensuring no down-stand beams are parallel to the edge of the deck.
- The soffit above an open deck having a width of more than 2 m should be provided with down-stands placed at 90° to the face of the building on the line of separation between individual flats or maisonettes. Down-stands should project 0.3 m to 0.6 m below any other beam or down-stand parallel to the face of the building.

Section 1: Means of Warning and Escape in Case of Fire

- (e) Where an open deck provides a single direction of escape (see [Diagram 27 \(b\)](#)), the following additional provisions apply:
- (i) The external wall of the building should achieve at least 30-minute fire resistance, up to a height of 1.8 m above the deck level; and
 - (ii) Any window with a cill set more than 1.1 m off the open deck is not required to be fire resisting; and
 - (iii) Doors opening onto the open deck should be E 30 fire doors; and
 - (iv) The required external balustrade should be imperforate.

There is no limitation on travel distance in open deck approach buildings. However, in buildings with a topmost floor level of more than 11 m, provisions relating to maximum hose length (see [Subsection 5.5.4.1](#)) should be applied.

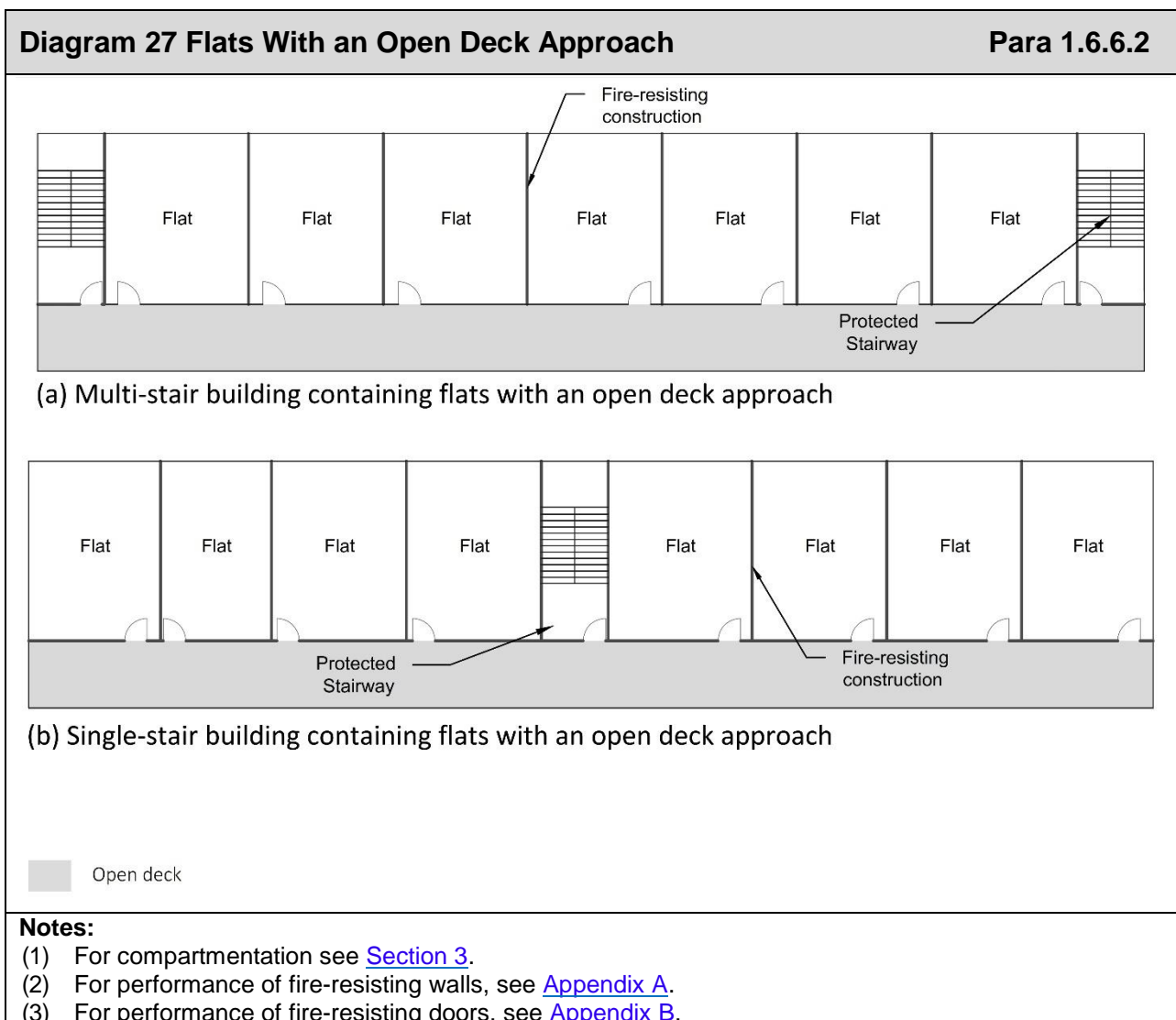

1.6.6.3 Buildings with an Enclosed Corridor / Lobby Approach

1.6.6.3.1 General provisions

A smoke control system (see [Subsection 6.6](#)) should be provided to corridor spaces in accordance with [Diagram 28](#), [Diagram 29](#), or [Diagram 30](#), as follows:

- (a) A natural (see [Para 6.6.2.1](#), [Para 6.6.2.2](#)) or mechanical (see [Para 6.6.2.3](#)) ventilation system may be used in buildings with a topmost floor height of less than 30 m.
- (b) A natural (see [Para 6.6.2.1](#), [Para 6.6.2.2](#)) or mechanical (see [Para 6.6.2.3](#)) ventilation system may be used in buildings with a topmost floor height of more than 30 m. The performance of any such system should be proven by fire engineering analysis.

1.6.6.3.2 Single direction of travel

In a building or portion of building with a single direction of travel, the following provisions apply:

- (a) The maximum travel distance, in a single direction (dead end) in a protected corridor provided with a smoke control system (see [Subsection 6.6](#)), irrespective of the topmost floor level, is 7.5 m.
- (b) Where every flat to a dead-end protected corridor / lobby on the same storey is provided with a sprinkler system (see [Para 8.4.1](#)), and the same protected corridor(s) / lobby(s) are provided with a smoke control system (see [Subsection 6.6](#)), the travel distance on that storey can be further extended up to a maximum of 15 m. This provision applies to ancillary accommodation on the same storey.
- (c) Any single direction of travel (dead-end) portion of a common corridor should be separated from the rest of the corridor by fire-resisting construction, which includes a self-closing fire door (see [Appendix B](#)), providing access to the escape stairs (see [Diagram 29](#) and [Diagram 30](#)).

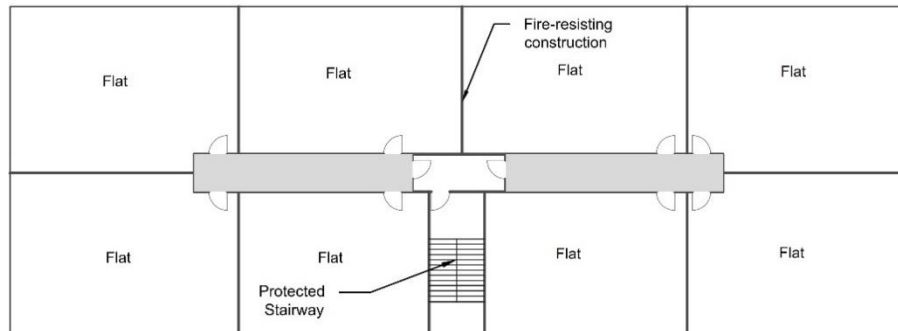

(a) Single stair building containing flats with protected corridor approach

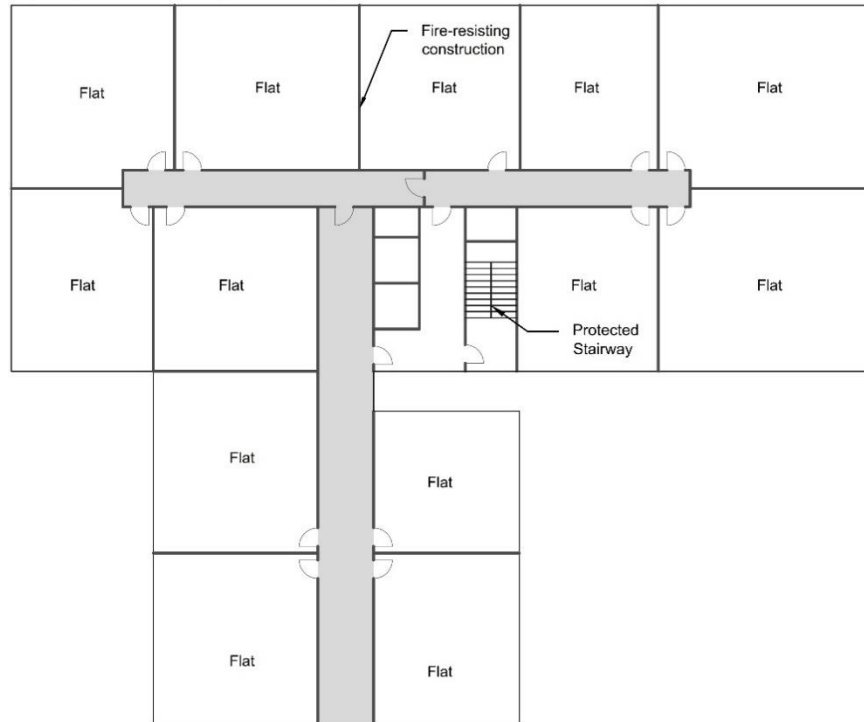

(b) Single stair building containing flats with protected corridor approach

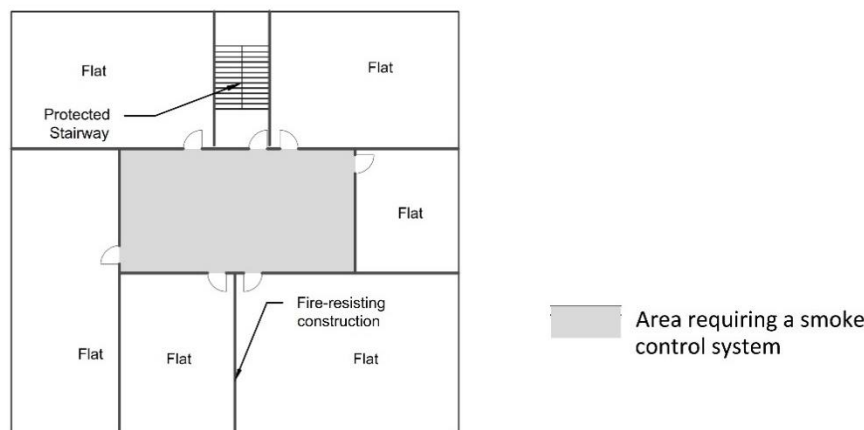

(c) Single stair building containing flats with protected lobby approach

Notes:

- (1) Maximum travel distance in a ventilated corridor/lobby in a single direction is 7.5 m. This may be increased to 15 m if every flat on the storey is provided with a sprinkler system (see [Para 8.4.1](#)).
- (2) For compartmentation see [Section 3](#).
- (3) For performance of fire-resisting walls, see [Appendix A](#).
- (4) For performance of fire-resisting doors, see [Appendix B](#).
- (5) Every dead-end corridor should be appropriately separated by self-closing fire doors from any part of the corridor which continues past one storey exit to another

Diagram 29 Flats with a Corridor / Lobby Approach - Multiple Stairs

Para 1.6.6.3

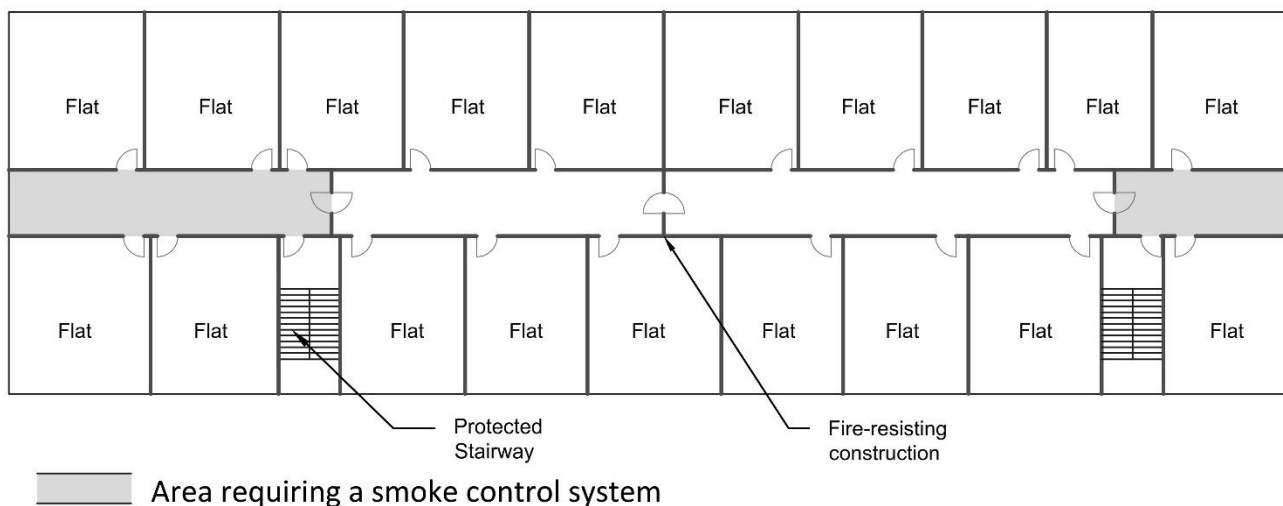

Notes:

- (1) Maximum travel distance in a common corridor/lobby in a single direction is 7.5 m. This may be increased to 15m if every flat on the storey is provided with a sprinkler system (see [Para 8.4.1](#)).
- (2) Maximum travel distance in a common corridor/lobby in more than one direction is 30m.
- (3) For compartmentation see [Section 3](#).
- (4) For performance of fire-resisting walls, see [Appendix A](#).
- (5) For performance of fire-resisting doors, see [Appendix B](#).
- (6) Every dead-end corridor should be appropriately separated by self-closing fire doors from any part of the corridor which continues past one storey exit to another.

1.6.6.3.3 More Than One Direction of Travel

In a building or portion of building with more than one direction of travel, the following provisions apply:

- (a) The maximum travel distance in a portion of corridor with an alternative escape route is 30 m.
- (b) Travel distance within any common corridor should be measured from the furthest entrance door to a flat to the protected stair, or lobby door. Such a lobby should provide direct access to the stair and should not provide direct access to a flat or ancillary accommodation.
- (c) Any length of corridor which provides access to two or more storey exits should be provided with centrally located fire doors (see [Appendix B](#)), where the maximum travel distance exceeds 15 m (see [Diagram 29](#), [Diagram 30](#)).

Diagram 30 Flats with a Corridor / Lobby Approach - Multiple Stairs Para 1.6.6.3



(a) Multi-stair building containing flats with a corridor approach, without dead ends.

(b) Multi-stair building containing flats with a corridor approach, T junction with main corridor

Notes:

- (1) Maximum travel distance in a common corridor / lobby in a single direction is 7.5 m. This may be increased to 15m if every flat on the storey is provided with a sprinkler system (see [Para 8.4.1](#)).
- (2) Maximum travel distance in a common corridor / lobby in more than one direction is 30m
- (3) For compartmentation see [Section 3](#).
- (4) For performance of fire-resisting walls, see [Appendix A](#).
- (5) For performance of fire-resisting doors, see [Appendix B](#).
- (6) Every dead-end corridor should be appropriately separated by self-closing fire doors from any part of the corridor which continues past one storey exit to another

1.6.7 Vertical Means of Escape in Common Parts of Flats

An important aspect of means of escape in multi-storey buildings is the availability of a sufficient number of adequately sized and protected escape stairways.

1.6.7.1 Number of Escape Stairs

A single stairway is acceptable where the constraints on travel distances (see [Para 1.6.6](#)) are met.

The provision of additional escape stairs will depend on the constraints on travel distance (see [Para 1.6.6](#)), and on whether independent stairs are required in mixed-occupancy buildings.

For buildings with a topmost floor level > 11 m, additional stairs may be required to satisfy the provisions of Section 5 (see [Subsection 5.5](#)).

1.6.7.2 Design of Escape Stairways

An escape stairway should conform to [Subsection 1.5](#).

In a building containing flats, the minimum stairway width should be 1.0 m.

In calculating the capacity of stairs, it is not necessary to discount a stair in a multi-stair building containing flats, however, the stairway should be appropriately sized for the number of individuals expected to use it in an emergency, for a simultaneous evacuation building.

A flat should not communicate directly with a stairway enclosure, or a protected exit passageway that serves a stair at ground or access level (see [Diagram 31](#)). This provision does not apply in the case of a small single stair building (see [Para 1.6.6.1](#), [Diagram 25\(b\)](#)) where each flat is provided with a protected entrance hallway, and accesses the stairway directly.

In single-stair buildings, an electric meter should not be installed within a common escape route unless it is enclosed within a secure cupboard which is separated from the common escape route by fire-resisting construction.

Access hatches for services shafts should not be provided within the enclosure to an escape stairway, or final exit passageway leading from an escape stairway at ground or access level, except where it is a shaft provided for smoke control purposes (see [Subsection 6.6](#)).

For connections to basements, see [Para 1.5.7](#).

Diagram 31 Final exit from a stairway

Para 1.6.7.2

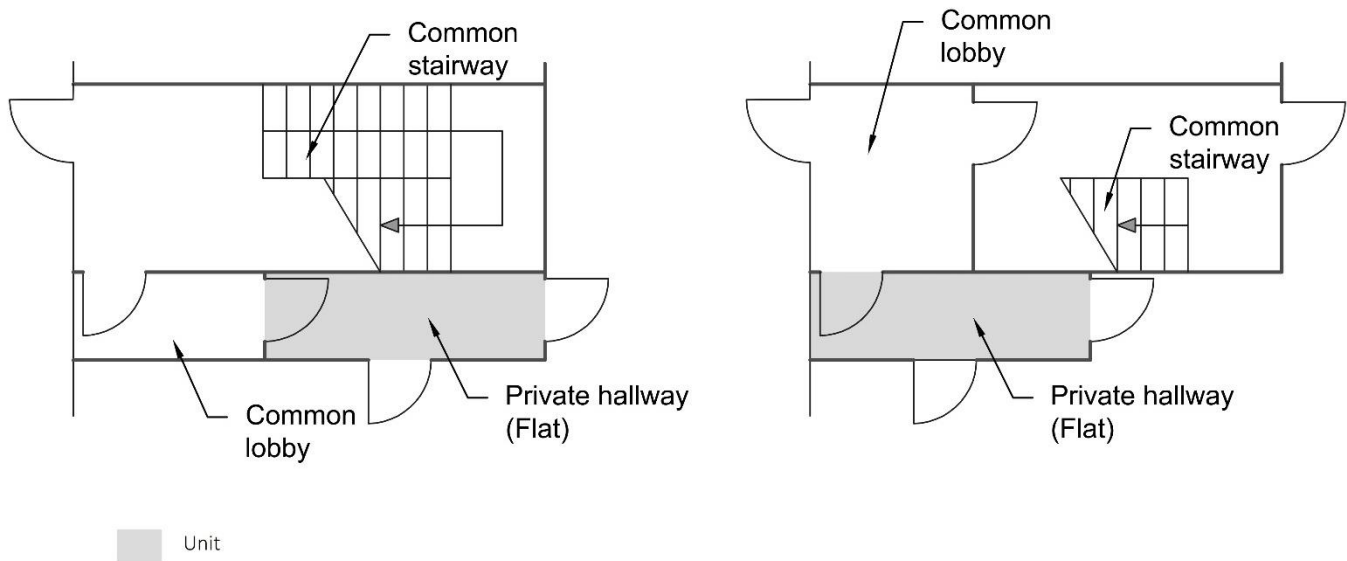
**Notes:**

- (1) For compartmentation see [Section 3](#).
- (2) For performance of fire-resisting walls, see [Appendix A](#).
- (3) For performance of fire-resisting doors, see [Appendix B](#).

1.6.8 Ancillary Accommodation

As well as meeting the above provisions (Para 1.6.1 to 1.6.7), ancillary accommodation in buildings containing flats (Purpose Group 1(c)) should also meet the provisions as specified in this section. Ancillary accommodation should meet the following provisions:

- (a) For travel distances, number of escape routes, widths of escape routes, etc. for ancillary accommodation designed for exclusive use by residents of the flats, the relevant provisions of [Subsection 1.4](#) should be applied.
- (b) In a small single stair building (see [Para 1.6.6.1](#)) ancillary accommodation should not connect with any part of the only escape route from one or more dwelling(s) on the same storey as the ancillary accommodation unless it is separated from the stairway by a protected lobby or corridor that is provided with permanent ventilation of not less than 0.4 m² for the control of smoke (see [Para 6.2.2](#)) or an equivalent mechanical smoke control system.
- (c) In a building with a single stair and an enclosed corridor / lobby approach (see [Para 1.6.6.3.2](#)), ancillary accommodation should only communicate with a ventilated portion of corridor, and should be separated from the common lobby or corridor by means of a protected lobby.
- (d) In multi-stair buildings (see [Diagram 32](#)), in any dead end portion of travel, ancillary accommodation should be separated from a protected lobby or protected corridor by means of a dedicated protected lobby.
- (e) If the stair serves an enclosed (non-open-sided) car park or a place of special fire risk, the lobby or corridor should have not less than 0.4 m² permanent ventilation or be protected from the ingress of smoke by a mechanical smoke control system.

Section 1: Means of Warning and Escape In Case of Fire

- (f) Communal rooftop areas, designed for the exclusive use of the occupants of the building should have travel distances as set out under Section 1.4. The structure forming the rooftop should be fire resisting in accordance with Appendix A. A sounder linked to the common fire detection and alarm system (see [Para 1.9.13](#)) should be provided to the rooftop area.

For refuge areas in buildings containing flats, see [Para 1.9.14.3](#).

Diagram 32 Ancillary Accommodation in Buildings Containing Flats Para 1.6.8

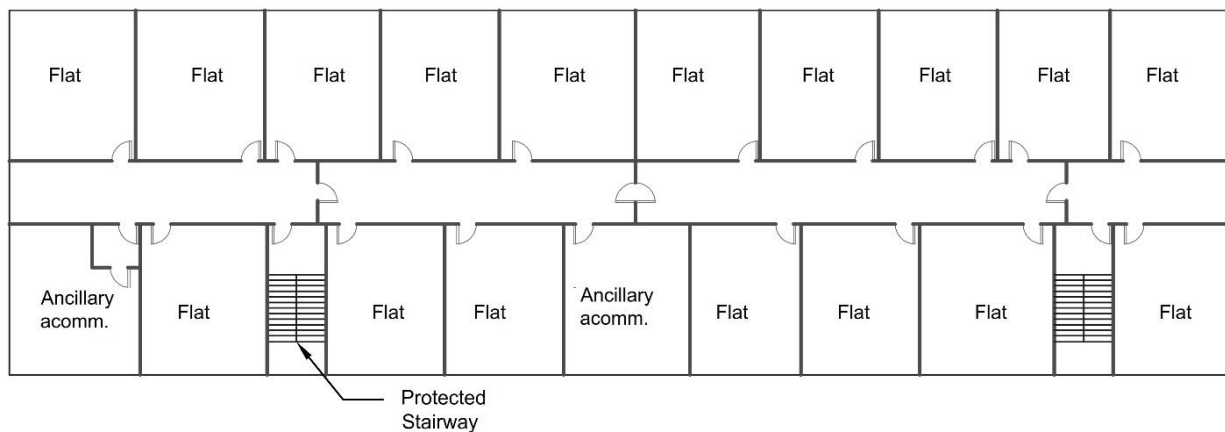

Notes:

- (1) For compartmentation see [Section 3](#).
- (2) For performance of fire-resisting walls, see [Appendix A](#).
- (3) For performance of fire-resisting doors, see [Appendix B](#).

Section 1: Means of Warning and Escape in Case of Fire

1.7 Means of Escape from Shopping Centres

1.7.1 Introduction

A shopping centre is a combination of a number of commercial premises (units) that are accessed via common areas (malls), principally for shopping purposes. The malls forming part of the shopping centre may be covered or uncovered.

The danger of rapid fire spread across a covered mall is greater than in an uncovered mall, and the effect upon the means of escape is more serious in a covered mall because its roof will prevent smoke and hot gases from escaping unless provision is made for smoke venting.

Guidance on the provision of means of escape from within the mall (both horizontal and vertical) is contained in this section. Shop fronts may be provided, but normally these would not offer any measure of fire-resisting separation.

There are two distinct components to planning means of escape from a shopping centre:

- (a) escape within individual units; and
- (b) escape within the common parts of the building (malls) that lead to a place of safety, or storey exit.

Each individual unit should be designed on the basis of its individual use (Purpose Group), according to [Subsection 1.4](#) and [Subsection 1.5](#).

The minimum widths of escape routes, whether in units, or common areas, should conform to [Table 5](#).

Service corridors, exit passageways, protected lobbies and protected corridors should be designed as virtually 'fire sterile' areas.

The minimum width of a mall is determined by the need to avoid fire spread across the mall by radiation and flame impingement, and the need to provide enough space for people to escape along the mall to a mall exit.

Child minding facilities should be designed such that they are located near to the main exits from the shopping centre.

Provisions relating to the compartmentation of units in shopping centres are set out in [Section 3](#).

Provisions relating to smoke control in shopping centres are set out in [Section 6](#).

Provision relating to sprinklers in shopping centres are set out in [Section 8](#).

Section 1: Means of Warning and Escape in Case of Fire

1.7.2 Units

1.7.2.1 Units Accessed from Outside a Shopping Centre

Shopping centres, whether covered or uncovered, can often have units forming part of the building, but which are accessed only from outside the building, and do not communicate directly with a mall. Such units are separated from the shopping centre by compartment construction (see [Section 3](#)).

Such units should be treated in a similar way to an independent shop unit accessed from a street, provided that they do not share an escape route with other shopping centre units.

1.7.2.2 Units Accessing a Mall in an Uncovered Shopping Centre

Means of escape in units accessed via an uncovered shopping centre mall should be treated similarly to means of escape for a unit accessed independently from the street.

Generally, the means of escape from a unit in an uncovered shopping centre is via the mall (see [Para 1.7.3](#)).

1.7.2.3 Units accessing a mall in a Covered Shopping Centre

Generally, the means of escape from a unit in a covered shopping centre is via the mall. Depending on the depth and size of the unit, an alternative means of escape may be required.

1.7.2.3.1 Number of Escape Routes from Units

Any unit accessed via a mall should be provided with an alternative means of escape, independent of the mall. An alternative means of escape is not required from any small unit or kiosk which:

- (a) does not exceed 25 m² in total area; and
- (b) is no more than 5 m in depth (i.e. the distance from the mall frontage to the back of the unit, including any non-retail space)

1.7.2.3.2 Alternate Means of Escape from Units

At least one alternative means of escape (see [Diagram 3](#), [Diagram 33](#)) from any unit (other than a small unit or kiosk) should deliver either at a different level from that at which the entrance to the unit is situated; or at the same level, but leading to different final exit(s).

Any exit from a unit that has an occupant capacity exceeding 300 persons should not discharge into a service corridor.

Section 1: Means of Warning and Escape in Case of Fire

Alternative exits from units, where required for these purposes, may be by means of:

- (a) a final exit; or
- (b) a service corridor (where the calculated occupant capacity of the unit is less than 300 persons), which leads to a storey exit or a final exit; or
- (c) an escape corridor / lobby which leads to a storey exit or final exit; or
- (d) unloading areas, service roads, vehicular roadways, and car parks. In general, in a shopping centre, escape via unloading areas, service roads and vehicular roadways is a less preferable arrangement than (a) to (c) above. Routes of adequate width need to be provided and these routes need to be segregated from such areas to ensure that the pedestrian routes remain unobstructed and are available for people who may need to use them. The car parks should be separated from the main shopping centre by fire-resisting construction.

An escape route within a shop unit may pass through an area of ancillary accommodation of the unit (see [Para 1.4.3.9](#)).

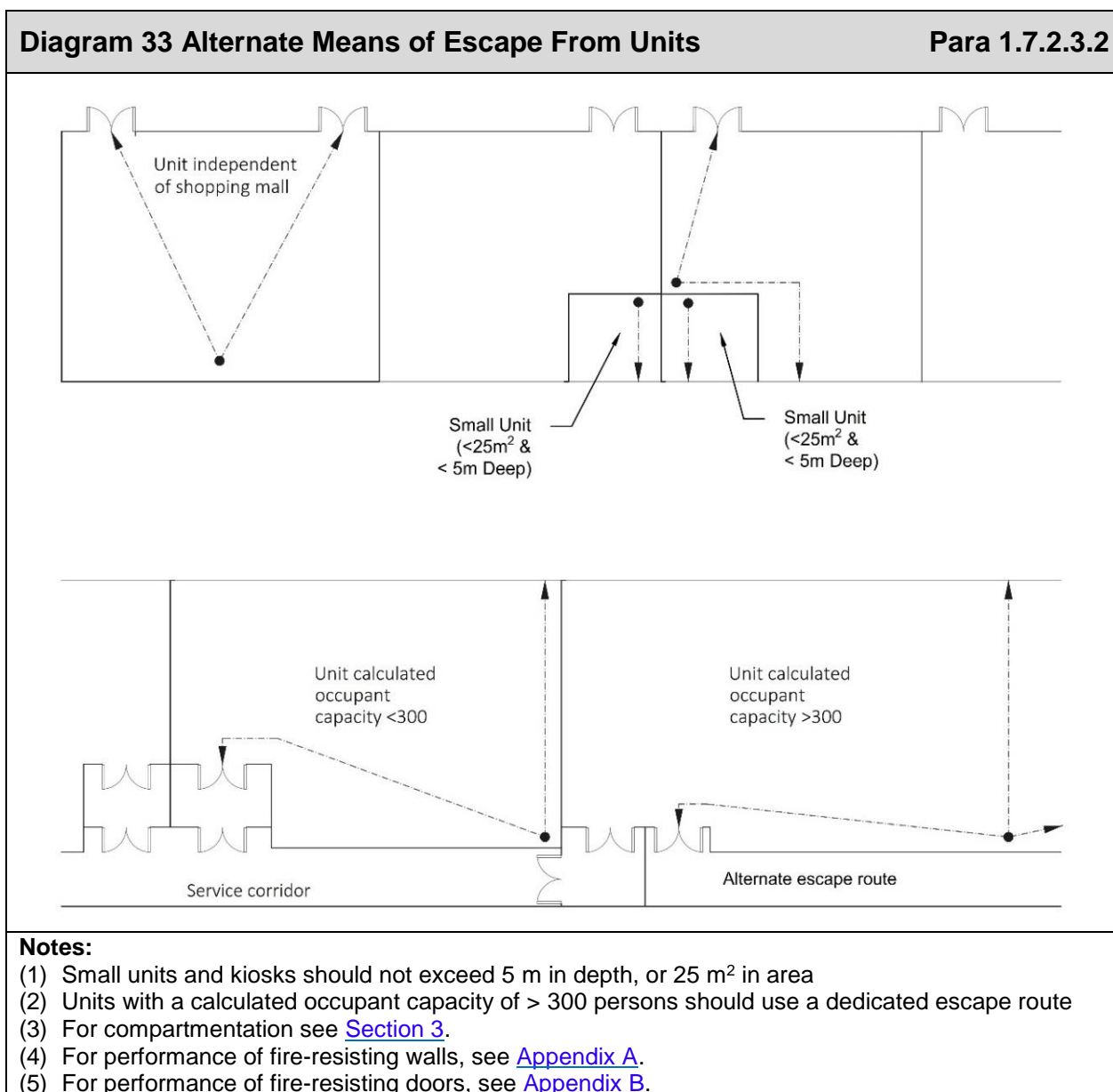

Section 1: Means of Warning and Escape in Case of Fire

1.7.2.3.3 Escape Routes Using Service Corridors

A service corridor used as an alternative means of escape from a unit (see [Diagram 34](#)) should conform to all of the following:

- (a) Not have more than one exit onto the corridor from individual units; and
- (b) Lead directly to a storey exit; and
- (c) Have a storey exit at each end, where the corridor length exceeds 45 m; and
- (d) Be at least 2 m wide, but not more than 3 m wide; and
- (e) Be provided with a CCTV system; and
- (f) Be separated from any ancillary accommodation and any goods lifts by a protected lobby (where any such lobby serves a goods lift, the lobby should have a depth not exceeding 12 m, or the lobby should be provided with an alternative means of escape); and
- (g) Be designed to ensure that the corridor remains relatively free from smoke by:
 - (i) separating each unit from the corridor by means of a protected lobby arranged so that the doors do not obstruct the corridor; or
 - (ii) subdividing the corridor with self-closing fire door(s) where the corridor provides access to two or more storey exits; or
 - (iii) providing a smoke control system to the corridor which is designed to maintain tenability for escape.

Any stair providing a means of escape from a service corridor should be constructed as a protected stairway.

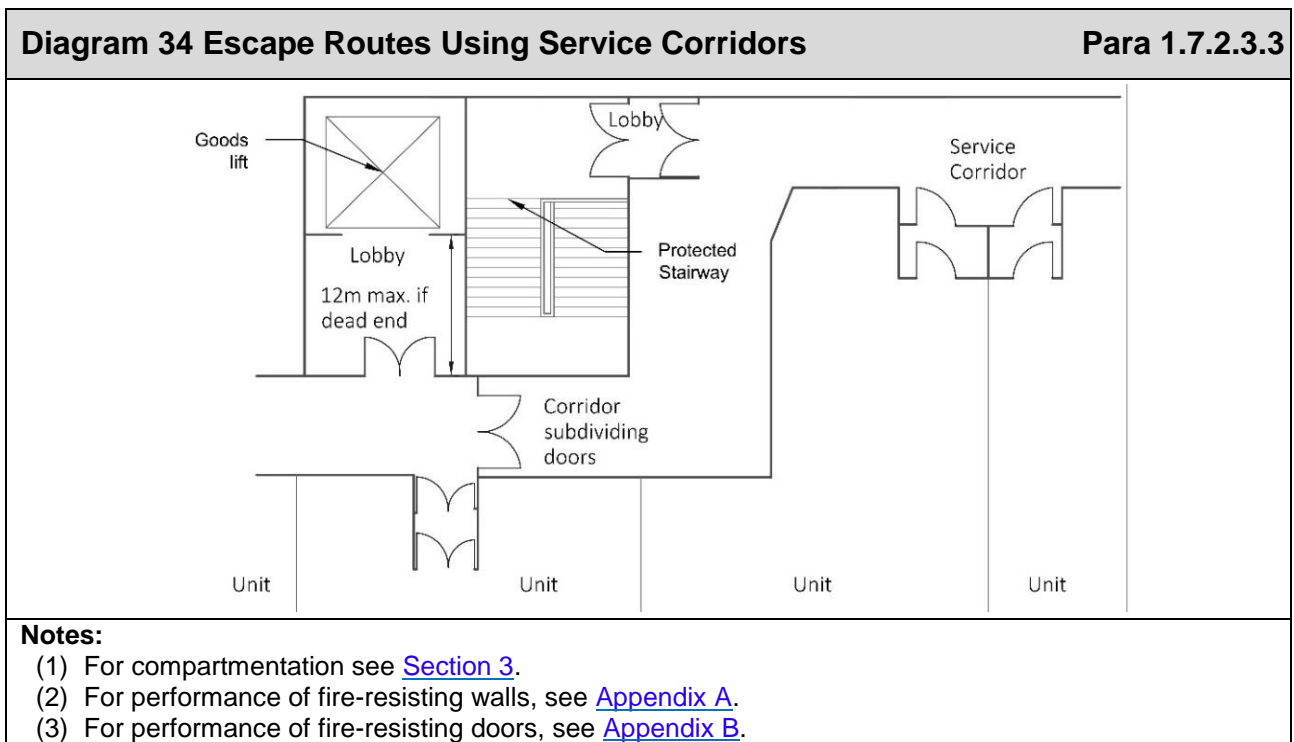

Section 1: Means of Warning and Escape in Case of Fire

1.7.3 Malls

The following paragraphs set out the provisions for means of escape from malls. Escape routes from malls should be by means of:

- (a) doors leading direct to the open air; or
- (b) dedicated mall exit passageways; or
- (c) protected stairways.

Escape routes from malls and walkways should not be via units.

Mall exits should not discharge into car parks, service roads or basement areas.

Where a shopping centre contains both covered and uncovered parts, the building should be designed to ensure that occupants should not need to enter a covered section of mall to reach a mall exit when escaping from a “dead-end” portion of an uncovered mall.

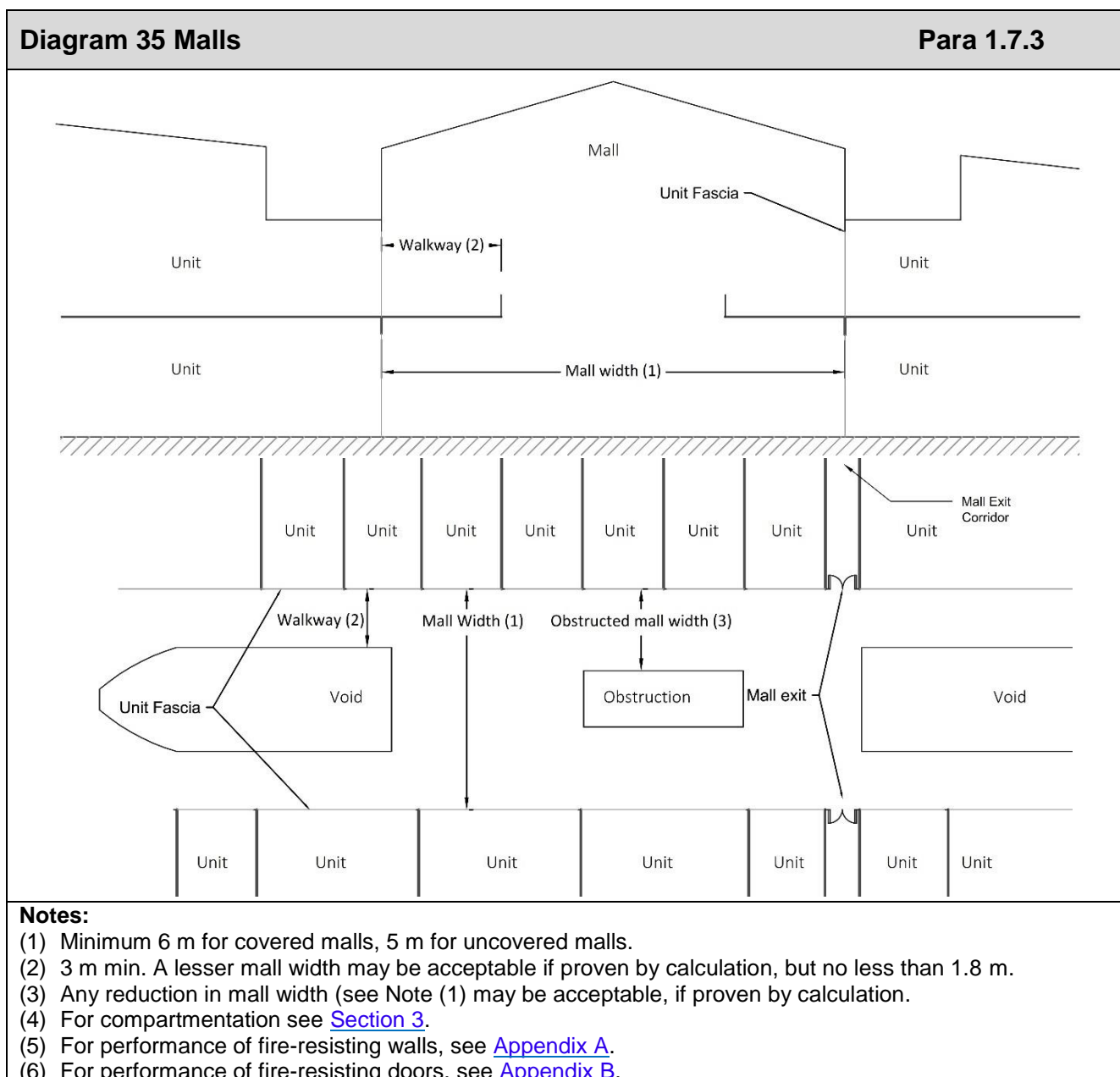

Section 1: Means of Warning and Escape in Case of Fire

1.7.3.1 Mall Widths

The width of malls (see [Diagram 35](#)), when measured between the fascia of each unit facing each other across the mall, should be:

- (a) not less than 6 m wide if covered; or
- (b) not less than 5 m wide if uncovered.

Where a mall in a covered shopping centre has units on both sides, the width of the mall, clear of any permanent obstructions or void openings, should be not less than 6 m.

A mall with a void on one side, such as a galleried upper mall overlooking the level(s) below, or a mall with units on one side and an imperforate fire-resisting wall on the other, should have an effective width of not less than 3 m. This width may be reduced, to not less than 1.8 m where it can be shown that the number of people using the mall for escape at that point can be safely accommodated. A similar approach should be adopted where the width of mall or galleried upper mall is reduced by an obstruction.

If doors are placed across a mall, their aggregate width should not be substantially less than that of the mall itself.

1.7.3.2 Number of Occupants of a Mall Section

The occupant capacity of a mall section (see [Diagram 36](#)) should be calculated by dividing the area of the mall section by the appropriate floor space factor.

The length of a mall section is measured by the distance between mall exits, based on the centre line of the exit from the mall.

The width of mall section should be measured in accordance with [Para 1.7.3.1](#).

The number of persons who can occupy a mall section should be calculated on the basis of:

- (a) the appropriate mall floor space factor, (calculated by dividing the mall area - mall section length x mall section width (in m²) - by the appropriate mall space factor of 0.75, unless:
 - (i) an area of the mall section has fixed tables and associated seating, in which case a floor space factor of 1.0 should be used for that area; or
 - (ii) the width of the mall section exceeds 8 m, in which case a floor space factor of 2.0 should be used for that part of the mall section in excess of 8 m; or
- (b) the aggregate population of the units served by the mall section exceeds the population calculated for the mall section, in which case this value should be used for the mall section capacity.

For calculation purposes, display areas and mall furniture (other than fixed seating for food courts) should not be deducted from the area of the mall; permanent display features (such as fountains) may be deducted.

Section 1: Means of Warning and Escape in Case of Fire

1.7.3.3 Widths of Mall Exits

The width of any particular escape route from a mall should be not less than the calculated minimum aggregate width divided by the number of escape routes, and should in no case be less than 1.8 m.

The required minimum aggregate width (W) in millimetres of exits should be calculated using the following equation:

$$W = 5 \times \text{mall occupant capacity (see [Para 1.7.3.2](#))}$$

1.7.3.4 Number of Exits from Malls

The number and location of mall exits should be such that the travel distance from any point in the mall does not exceed the limitations given in [Table 3](#) (see [Diagram 37](#)).

Where more than one mall exit is required, the escape routes should be in more than one direction. For escape to be considered in more than one direction, the provisions of [Para 1.4.2.3](#) should be complied with.

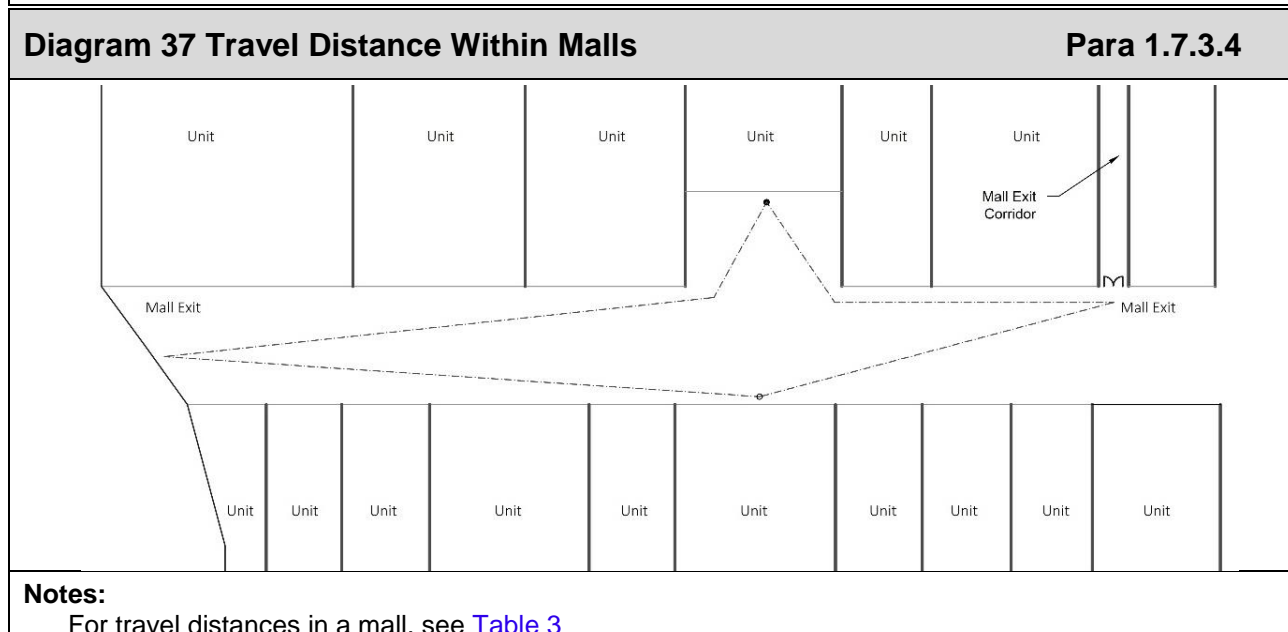
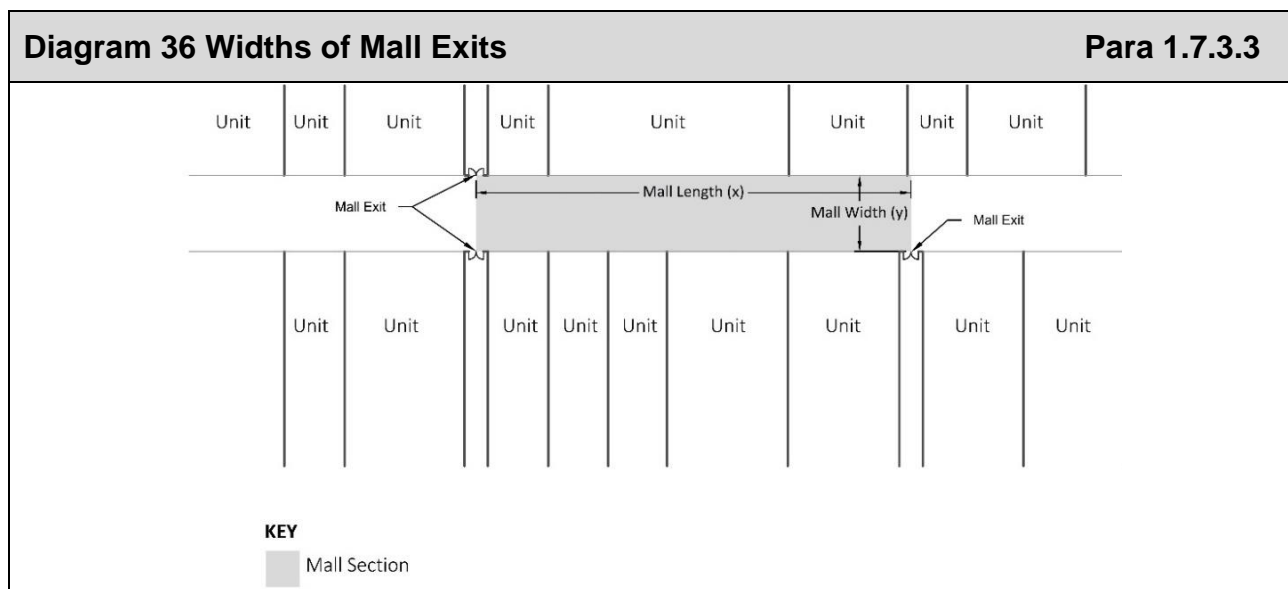

Section 1: Means of Warning and Escape in Case of Fire

1.7.4 Stairs and Final Exits from a Shopping Centre

For a shopping centre with a storey above ground level, there should be not less than two protected stairways available from each storey.

Additional protected stairways should be provided as necessary to meet requirements for travel distance.

Access to protected stairways should be sited away from open connections between mall levels.

Protected stairways should be provided in accordance with [Subsection 1.5](#), and the following, where applicable.

If a protected stairway, other than an external stair, serves a storey or storeys in any of the following circumstances, it should be approached only by way of a protected lobby or protected corridor, as follows:

- (a) If any upper storey of a building (or part of a building) is served by an escape stairway, then that stairway should not be continued down to serve any basement storey. Any escape stairway between a basement and the ground storey should be separated by a protected lobby or protected corridor from the stairway serving the upper storeys at ground level.
- (b) If the stair connects the ground or upper storeys with a basement storey or storeys, or serves only basement storeys, there should be a ventilated protected lobby or ventilated protected corridor (see [Para 1.5.8.3 \(c\)](#), [Para 6.2.2](#)) at every basement level, unless:
 - (i) the stair is provided with a smoke control system using pressure differentials; or
 - (ii) the basement comprises a lower mall level which is provided with smoke ventilation arrangements (see [Subsection 6.10](#)).
- (c) If the stair serves a mall or walkway and a service corridor, the service corridor should be separated from the stair by a protected lobby (see [Para 1.5.8.3 \(c\)](#)).
- (d) If the stair provides access to an enclosed car park, there should be a ventilated protected lobby (see [Para 1.5.8.3 \(c\)](#)) or ventilated protected corridor (see [Para 6.2.2](#)) at every car park access level.

Any corridor connecting a mall exit from a covered mall or walkway with a protected stairway or final exit should be a protected corridor which has no openings or doors to any adjacent accommodation.

Section 1: Means of Warning and Escape in Case of Fire

1.7.5 Ancillary Accommodation

1.7.5.1 Introduction

Many forms of ancillary accommodation are necessary in shopping centres, and it is desirable that, wherever possible, these are located in the non-public areas in order that public areas are effectively isolated from any hazard which the ancillary accommodation may impose.

Other accommodation, not normally available to the public but for which access from public common areas may be required, is that associated with the management of the shopping centre for administrative purposes and may include offices and staff rooms.

Management suites should be considered as a unit for the purposes of means of escape. As such, management suites should be designed as office units (Purpose Group 3) in accordance with [Subsection 1.5](#) for escape within the unit, and Para's 1.7.1 – 1.7.4 for escape outside the unit to a final exit.

1.7.5.2 Means of Escape from Ancillary Accommodation

Common engineering services, stores, servicing areas and management areas remote from the management suite should be considered as ancillary accommodation.

Corridors serving ancillary accommodation (including service installation rooms) should be enclosed by construction with a fire resistance of not less than 30 minutes, and all doors within the enclosures should be fire resisting and self-closing (see [Appendix B](#)).

Non-public common areas and ancillary accommodation should be designed in accordance with [Subsection 1.4](#) and [Subsection 1.5](#) of this document, and the following:

- (a) Ancillary accommodation should be separated from any protected stairway by a protected lobby or protected corridor (having a fire resistance as set out in Appendix A, [Table 31](#)) at the storey in which the accommodation is situated.
- (b) Ancillary accommodation should be separated from any corridor available to the public by a protected lobby (having a fire resistance as set out in Appendix A, [Table 31](#)).
- (c) Corridors serving ancillary accommodation should be enclosed by fire-resisting construction (having a fire resistance as set out in Appendix A, [Table 31](#)) and all doors within the enclosures should be fire-resisting and self-closing.

Section 1: Means of Warning and Escape in Case of Fire

1.7.5.3 Means of Escape from Occupancies Other than Shopping Centre Units

Shopping centres or developments can contain office blocks, hotels, residential accommodation and places of entertainment such as theatres and cinemas, dance halls, concert halls and assembly halls.

Each of these other occupancies should have its own internal means-of-escape arrangements set out in accordance with [Subsection 1.4](#) and [Subsection 1.5](#) of this document.

Alternative exits from these other occupancies should not discharge onto a mall even where they may have an entry from a mall.

Vertical means of escape from these other occupancies should be independent of any protected stairways serving a mall or shop unit of a shopping centre.

1.7.6 Wayfinding and Spatial Orientation

Shopping centres should be designed such that:

- (a) Confusing spatial layouts are avoided; and
- (b) All exits in covered shopping complexes, including exits from the individual malls and the final exits from the shopping complex, are marked and are readily visible to the occupants of the shopping complex; and
- (c) Intermediate exit signs are provided as necessary in public common areas so that no part of a public common area is more than 25 m from an exit sign or directional exit sign; and
- (d) fire safety signs and notices comply with the relevant requirements of [Para 1.9.12](#) and BS 5499; and
- (e) Emergency announcements on any public address system and any electronic visual displays relates to, and augments, exit signs and directional signs.

Section 1: Means of Warning and Escape in Case of Fire

1.8 Small Premises (Offices and Shops)

Small premises are generally limited in size and in number of occupants. When a premises is undivided, all of its parts are likely to be clearly visible to occupants. Occupants of small premises should be able to reach an exit quickly in an emergency, and a reduction in the number of exits and stairs is therefore acceptable.

This subsection applies to offices (Purpose Group 3) and shops (Purpose Group 4(a)). A small premises should meet all of the following provisions:

- (a) It should be single occupancy; and
- (b) It should not comprise more than a basement floor, ground floor and first floor; and
- (c) No storey should have a floor area more than 280 m²; and
- (d) Any kitchen or open main cooking appliances should be at the extremity of any dead end remote from the exits.

Where the above provisions are satisfied, Paragraphs 1.8.1 to 1.8.3 may be used in place of similar provisions contained in [Subsection 1.4](#) and [Subsection 1.5](#).

This Subsection does not apply to units in a shopping centre (Purpose Group 4(b)).

Minimum widths of escape routes should conform to [Table 5](#).

1.8.1 Construction

Except for kitchens, ancillary offices and stores, floor areas should be undivided so that exits are clearly visible from all parts on the same storey. Inner rooms should meet the provisions of [Para 1.4.3.4](#).

Store rooms should be enclosed with fire-resisting construction (see Appendix A).

Where a basement is part of the small premises, the floor between the basement and the ground floor need not be a compartment floor (see [Para 3.4.4.5](#)).

1.8.2 Travel Distance and Number of Escape Routes

Escape routes should be sited so that the travel distance from any point of a storey to the nearest storey exit does not exceed the distance given in [Table 10](#) (see [Diagram 38](#)).

Travel distance in a small premises with an open stairway may be measured to the foot of the stair in a basement or to the head of the stair in a first storey.

Where there are two or more exits or stairs, these should be located so as to give effective alternative directions of travel from any point in a storey.

Section 1: Means of Warning and Escape in Case of Fire

Table 10 Maximum Travel Distances in Small Premises

Storey	Maximum travel distance (m)	Maximum direct distance (m)
Ground storey with a single exit	27	18
Basement or first storey with a single stair	18	12
Storey with more than one exit / stair	45	30

Diagram 38 Small Premises (Offices and Shops)

Subsection 1.8

(a) Small premises (3 storeys) with protected stair (1)

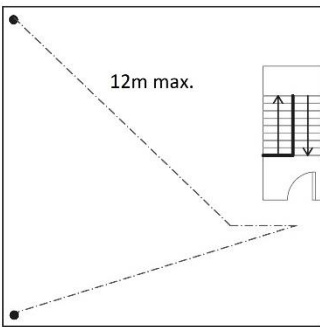

(i) First Storey

(b) Small premises (2 storeys) with open stair (2)

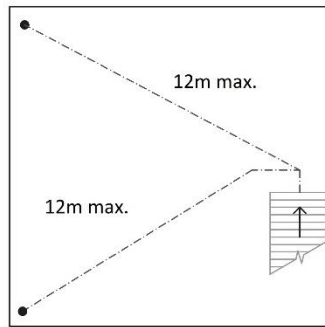

(i) Basement or First Storey

(c) Small premises (3 storeys) with one open, one protected stair (3)

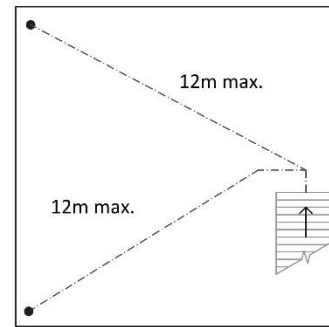

(i) First Storey

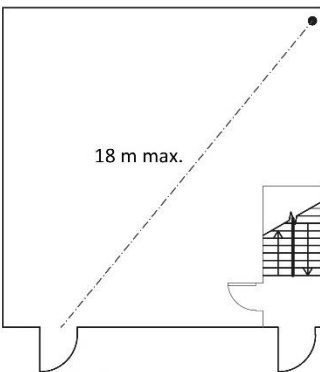

(ii) Ground Storey

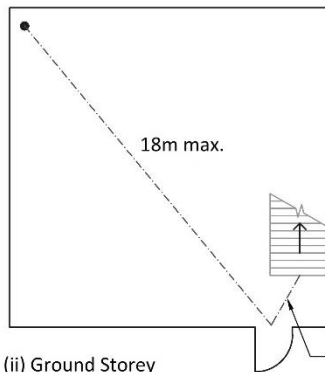

(ii) Ground Storey

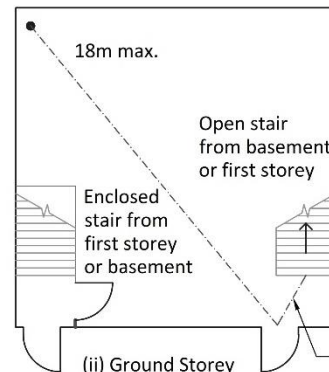

(ii) Ground Storey

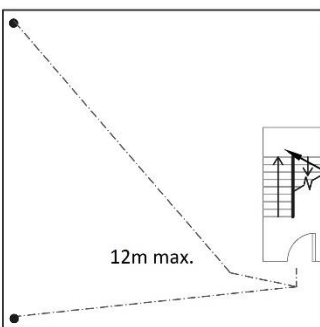

(iii) Basement

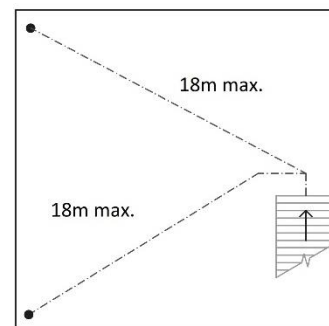

(iii) Basement

Notes:

- (1) Max floor area in any one storey is 280 m².
- (2) Max floor area in any one storey is 90 m², only acceptable in two-storey premises.
- (3) Max floor area in any one storey is 90 m², enclosed stair at ground floor level may be from either the basement or the first storey.

Section 1: Means of Warning and Escape in Case of Fire

1.8.3 Escape Stairs in Small Premises

1.8.3.1 Protected stairways

A single protected escape stair should be provided in all small premises (see [Diagram 38](#) (a)), except where Para 1.8.3.2 applies.

1.8.3.2 Open stairways

An open stairway may be used as a means of escape in a small premises, where:

- (a) The stair connects a maximum of two storeys; and
- (b) The stair delivers at the ground storey no more than of 3 m from the final exit (see [Diagram 38](#) (b)); and
- (c) Either
 - (i) the storey being served by the open stair is also served by a protected stairway;
or
 - (ii) the floor area of any single storey is a maximum of 90 m².

Where a small premises contains three storeys, a stair serving one of the storeys may be open, however the stair serving the other storey should be constructed as a protected stair (see [Diagram 38](#) (c)).

1.9 General Provisions for Means of Escape

1.9.1 Introduction

This subsection deals with a number of provisions about the construction and protection of escape routes generally, and about some services installations and other matters associated with the design of escape routes. It applies to all buildings to which this document applies.

It should therefore be read in conjunction with Subsections 1.4 to 1.8 of this document.

1.9.2 Protection of Escape Routes

1.9.2.1 Fire Resistance of Enclosures

Details of fire-resistance test criteria, and of standards of performance, are set out in [Appendix A](#) to this document.

All walls, partitions and other enclosures that need to be fire resisting to meet the provisions in this document should have the appropriate performance given in [Table 31](#) and [Table 32](#) of [Appendix A](#). They should also meet any limitations on the use of glass (see [Para 1.9.2.3](#)).

1.9.2.2 Fire Resistance of Doors

Details of fire-resistance test criteria, and standards of performance for fire doors, are set out in [Appendix B](#) to this document.

The performance of a fire door will critically depend on the correct installation of the complete door assembly.

All doors that need to be fire resisting to meet the provisions in this document should have the appropriate performance given in [Table 36](#) of [Appendix B](#). They should also meet any limitations on the use of glass (see [Para 1.9.2.3](#)).

1.9.2.3 Fire Resistance of Glazed Elements

Where glazed elements in fire-resisting enclosures and doors are able to satisfy the relevant performance only in terms of integrity, there are limitations on the use of glass. These limitations are set out in [Appendix A](#), [Table 34](#), and [Table 37](#).

Where the relevant performance can be met in terms of both integrity and insulation, there is no restriction on the use or amount of glass, but there may be some restriction on the use of glass under [Section 3](#) or [Section 5](#).

Section 1: Means of Warning and Escape in Case of Fire

1.9.2.4 Protection of Escape Stairways

The protection of escape stairways should be in accordance with the provisions outlined at [Para 1.5.6](#), unless the stairway is an unprotected stairway forming part of an escape route from a gallery in accordance with [Para 1.4.3.10](#) or is in a small premises in accordance with [Para 1.8.3](#). Stairways in hospitals (Purpose Group 2(a)(i)) should be in accordance with HTM 05-02 (see [Para 1.2.1](#)).

1.9.3 Doors on Escape Routes

The time taken to negotiate a closed door can be critical in an escape situation. Doors on escape routes (both within and from the building) should therefore be readily openable without delay. Accordingly, the provisions in the paragraphs below should be met.

1.9.3.1 Door Fastenings

1.9.3.1.1 General

In general, doors on escape routes, whether or not the doors are fire doors, should conform to one of the following:

- (a) Not be fitted with lock-, latch- or bolt-fastenings, unless the fastening is a device which conforms to I.S. EN 179; or
- (b) panic hardware, compliant with I.S. EN 1125, on doors which open in the direction of escape; or
- (c) Be fitted only with a simple fastening that complies with all of the following:
 - (i) It should be easy to operate; it should be apparent how to undo it; and
 - (ii) It should be operable from the side approached by people escaping; and
 - (iii) It should be operable without a key or other similar object; and
 - (iv) It should be operable without requiring people to manipulate more than one mechanism.

Devices, conforming to I.S. EN 179 or I.S. EN 1125 are not intended for use on double action (double swing) doors unless specifically designed by the producer.

Section 1: Means of Warning and Escape in Case of Fire

1.9.3.1.2 Electrically Powered Locks

Electrically powered locks (which may be operated by code or combination keypad, swipe or proximity card, biometric data, etc.) should return to the unlocked position in any of the following cases:

- (a) On operation of the fire-alarm system; or
- (b) On loss of power or in the case of system error; or
- (c) On activation of a manual door-release unit positioned at the door on the side approached by people making their escape. Where the door provides escape in either direction, a unit should be installed on both sides of the door.

A device installed in accordance with the provisions of I.S. EN 13637:2015 may be used on escape routes.

1.9.3.1.3 Security

Where security on final exit doors is an important consideration panic bolts complying with IS EN 1125 or IS EN 13637 should be used to secure doors.

1.9.3.1.4 Flats

Any door from a flat to a common escape route, should be provided with simple fastenings (thumb latches or other readily openable mechanism) which can be operated from the escape side without the use of a key.

1.9.3.2 Doors in Buildings with Large Numbers of People

The following provisions apply to buildings, or parts of buildings, which are used as a shop (Purpose Group 4 (a)), as a shopping centre (Purpose Group 4 (b)), or for assembly and recreation (Purpose Group 5 (a) and (b)) uses:

- (a) Exit doors from areas holding more than 50 people should either be free from fastenings or be fitted with panic bolts complying with I.S. EN 1125 or I.S. EN 13637.
- (b) Doors other than those covered by item (a), should comply with the provisions of [Para 1.9.3.1](#).

Information about door-closing and hold-open devices for fire doors is given in [Appendix B](#).

Section 1: Means of Warning and Escape in Case of Fire

1.9.3.3 Direction of Opening

Doors on escape routes should be hung so that they open in the direction of escape. In the case of small rooms or buildings, this may not be practical or indeed necessary, but in the following situations, doors on escape routes must always be hung to open in the direction of escape:

- (a) from a place of special fire risk; or
- (b) in the case of classrooms and other small rooms in schools (Purpose Group 5(a)(ii)) where the number of persons in such rooms does not exceed 60 persons; or
- (c) in the case of any other premises comprising an Assembly and Recreation (Purpose Group 5), Industrial (Purpose Group 6), or Storage (Purpose Group 7) use, if more than 20 persons are expected to use them; or
- (d) in the case of any other premises, if more than 60 persons are expected to use them.

Manual sliding doors may be permitted, in certain limited circumstances only, such as doors from rooms in industrial (Purpose Group 6), or storage (Purpose Group 7) buildings which are occupied by not more than 10 persons and where swing doors would be impracticable.

1.9.3.4 Amount of Opening, and Effect on Associated Escape Routes

All doors on escape routes should:

- (a) be hung to open not less than 90°; and
- (b) be hung with a swing that is clear of any change of floor level, other than a threshold, (of no more than 15mm), on the line of the final exit doorway; and
- (c) not reduce the required width of any escape route across a landing; and
- (d) not reduce the required width of any corridor onto which it opens (this may require the door to be recessed).

1.9.3.5 Vision Panels

Doors should contain vision panels in either of the following situations:

- (a) where doors on escape routes divide corridors, or
- (b) where doors are hung to swing both ways.

Where such vision panels are provided, they should conform to the requirements for vision panels specified in Technical Guidance Document M (Access and Use).

Section 1: Means of Warning and Escape in Case of Fire

1.9.3.6 Revolving and Automatic Doors

Revolving doors, automatic doors and turnstiles can obstruct the passage of persons escaping. These types of doors should not be provided across escape routes unless:

- (a) swing doors to the required width are provided immediately adjacent; or
- (b) they are automatic doors complying with I.S. EN 16005 and either:
 - (i) they are arranged to fail safely to outward opening from any position of opening; or
 - (ii) they are provided with a monitored fail safe system for opening the doors if the mains power supply fails.

1.9.3.7 Self-closing devices

All fire doors should be fitted with an automatic self-closing device which is capable of closing the door from any angle and against any latch fitted to the door (see [Appendix B](#)). Where self-closing doors could present an obstacle to the occupants of the building, then the following hardware in accordance with I.S. EN 1155 may be acceptable:

- (a) doors to rooms – free-swing door closers; or
- (b) circulation spaces – hold-open devices.

Fire doors to cupboards and to service ducts which are kept locked shut (or a cupboard / hot press in a flat which does not need to be kept locked shut) do not require a self-closing device.

1.9.4 Construction of Escape Stairways

1.9.4.1 General

Every common escape stairway and its associated landings should be constructed of materials having a reaction to fire classification achieving Class A2-s3, d2, or better, in any of the following situations:

- (a) if it is the only stairway serving the building, or part of the building, and the period of fire resistance for the elements of structure ([Table 31](#) and [Table 32](#) to Appendix A) is 60 minutes or more; or
- (b) if it serves a topmost floor of more than 11 m above ground or access level; or
- (c) if it is within a basement storey; or
- (d) if it is an external stairway (There are other provisions about external escape stairways in [Para 1.5.9](#)); or
- (e) if it is a residential (care facility) building (Purpose Group 2(a)(ii)).

The provisions of this subsection do not apply to a private, intermediate stair in a flat (maisonette).

Section 1: Means of Warning and Escape in Case of Fire

1.9.4.2 Helical and Spiral Stairways

Helical and spiral stairways should comply with the recommendations of BS 5395-2.

If they are intended to serve members of the public, helical and spiral stairways should meet the requirements for a Type E (public) stairway to that standard.

For helical and spiral stairways in public buildings, see Para 1.1.6 of Technical Guidance Document K.

1.9.4.3 Fixed Ladders

Fixed ladders should not be provided as a means of escape for members of the public. They should only be provided where a conventional stair is impractical, such as for access to plant rooms which are not normally occupied.

In addition, fixed ladders should be constructed of materials having a reaction-to-fire classification of Class A1.

Fixed ladders should comply with the recommendations of BS 5395-3.

1.9.5 Height of Escape Routes

All escape routes should have a minimum clear headroom of not less than 2 m, and there should be no projection below this height which would impede the free flow of persons using them. An exception to this is a door frame.

1.9.6 Floors of Escape Routes

The floors of all escape routes, excluding floors forming part of tiered seating (see [Para 1.4.7](#)) should generally be level.

All escape routes including steps, ramps and landings should have even surfaces and be slip resistant, especially when wet. Guidance on slip resistance is given in BS 8300 Annex E.

Where a ramp forms part of an escape route, it should not be steeper than 1 in 12 if it is shorter than 10 m; otherwise, it should not be steeper than 1 in 20.

For ramps on access routes that also serve as egress routes, refer to Technical Guidance Document M (Access and Use).

Section 1: Means of Warning and Escape in Case of Fire

1.9.7 Final Exits

Final exits should:

- (a) be dimensioned and sited so that they facilitate the evacuation of persons out of the building, and away from the building; and
- (b) be not less in width than the escape route(s) they serve (see [Subsection 1.4](#)). The capacity of final exits may be calculated in accordance with [Para 1.4.3](#) or [Para 1.5.4.1](#) as appropriate. Final exits from a stairway should be no less than the required escape width of the escape stair; and
- (c) be sited to ensure rapid dispersal of persons from the vicinity of the building so that they are no longer in danger from fire and smoke; and
- (d) lead directly to a street, passageway, walkway or open space. In situations where the exit discharges other than to an open street or open space at street level, the route clear of the building, leading to a street, passageway, walkway or open space, should be well defined, and suitably guarded, if necessary; and
- (e) be apparent to persons who may need to use them. This is particularly important where the exit opens off a stairway that continues down, or up, beyond the level of the final exit; and
- (f) be sited such that it is not less than 1.8 m from:
 - (i) vents from a basement; or
 - (ii) openings to transformer chambers, boiler rooms and similar risks; and
- (g) Lead to an open space:
 - (i) by a route that leads directly away from the building; or
 - (ii) by a choice of routes; or
 - (iii) close to the building; where the route is within 1.8m of the facade, the associated external wall should be fire resisting (having a fire resistance as set out in Appendix A, [Table 31](#)) to 1.8 m above the level of the escape route (see [Diagram 15](#) (b)).

1.9.8 Lighting of Escape Routes

1.9.8.1 Provision of Normal Lighting

The safe movement of persons along escape routes, towards and through the exits to a place of safety, depends on the illumination of those routes and the ability to see hazards and changes of level and direction. Adequate artificial lighting should be provided to all internal and external escape routes.

Section 1: Means of Warning and Escape in Case of Fire

1.9.8.2 Requirement for Emergency Lighting

In the event of failure of the normal lighting, emergency escape lighting is required. Emergency escape lighting is required to ensure that lighting is provided promptly, automatically and for a suitable duration when the normal lighting fails.

Emergency escape lighting is required:

- (a) on complete failure of the power supplies to the normal lighting in the building; or
- (b) on a localised failure of the normal lighting.

Table 11 Provision of Emergency Escape Lighting		Para 1.9.8.3
Use of building or part of building	Purpose Group ⁽¹⁾	Parts requiring emergency escape lighting
Flats	1(c)	Defined escape routes, other than within dwellings. Ancillary accommodation, including rooftop amenities
Residential (care facility)	2(a)	Defined escape routes, wards, treatment rooms, communal rooms, bathrooms and toilet areas, kitchens, other rooms over 30 m ² in area
Residential (other)	2(b)	Defined escape routes, dormitories, common rooms, kitchens, other rooms over 30 m ² in area
Offices	3	Defined escape routes and undefined escape routes over 60 m ² in area
Shops	4(a)	Defined and undefined escape routes ⁽²⁾
Shopping Centre	4(b)	Defined and undefined escape routes within individual shop units and in mall and concourse areas.
Assembly and recreation	5	Defined and undefined escape routes ⁽³⁾
Industrial	6	Defined escape routes and undefined escape routes over 60 m ² in area
Storage	7	Defined escape routes and undefined escape routes over 60 m ² in area
Other non-residential	8	Defined escape routes, common areas, rooms over 30 m ² in area
Any use other than dwelling houses	1(c), 2 to 8	Emergency generator room, switch room, plant room, battery room for emergency lighting system.
Any use other than dwelling houses	1(c), 2 to 8	External escape routes as required ⁽⁴⁾
<p>Notes:</p> <p>(1) See Table 1.</p> <p>(2) Except a shop at ground floor with a sales area less than 100 m² and maximum travel distance of 15 m to a final exit to a public area.</p> <p>(3) Except in accommodation open on one side, with naturally lit escape routes, to view sport or entertainment during normal daylight hours; and except toilet accommodation having a floor area of not more than 8 m².</p> <p>(4) Except where there is sufficient external lighting from a public or other independent power supply.</p>		

Section 1: Means of Warning and Escape in Case of Fire

1.9.8.3 Provision of Emergency Lighting

Emergency escape lighting should be provided to:

- (a) clearly and unambiguously indicate the escape routes so that the means of escape can be safely and effectively used; and
- (b) provide illumination along such routes to allow safe movement towards and through the exits provided; and
- (c) ensure that fire-alarm call points, and fixed hose reels (see [Para 1.9.15](#)), where provided, can be readily located.

Emergency escape lighting should be provided in accordance with the provisions indicated in [Table 11](#) and should be designed and installed in accordance with the relevant recommendations of I.S. 3217 or equivalent.

1.9.9 Lifts

1.9.9.1 Introduction

Because lifts, by their nature, connect floors, there is the possibility that they may prejudice escape routes. To safeguard against this, the provisions in the paragraphs below should be met. Passenger lifts should comply with the Lift Directive 2014/33/EU.

1.9.9.2 Fire Protection of Lifts

Lift wells should be either contained within the enclosures of a protected stairway, or be enclosed throughout their height with fire-resisting construction if they are sited such as to prejudice a means of escape. A lift well that connects different compartments should form a protected shaft (see Section 3, [Para 3.5.16](#)).

1.9.9.3 Provision of Lobbies to Lifts

Lifts should be approached only by way of a ventilated (see [Para 6.2.2](#)) protected lobby (or protected corridor) in:

- (a) a basement; or
- (b) any storey that contains an area such as a kitchen, lounge, store, or place of special fire risk (see [Subsection 0.10](#)) and where the lift also delivers directly into corridors serving sleeping accommodation; or
- (c) an enclosed car park.

1.9.9.4 Lifts in Buildings > 20m

In buildings with any storey at a height greater than 20 m, lifts should be approached by way of a protected lobby / protected corridor (see [Para 1.5.8](#)).

Section 1: Means of Warning and Escape in Case of Fire

1.9.9.5 Lifts Serving Basements

A lift should not be continued down to serve any basement storey if it is in a building (or part of a building) served by only one escape stairway, or within the enclosures to an escape stairway which is terminated at ground level. Provisions on escape stairways that connect basements with the upper storeys of a building are set out in [Subsection 1.5](#).

1.9.9.6 Lift Machine Rooms

Lift machine rooms should be sited over the lift well whenever possible. If the lift well is within the enclosures to a protected stairway being the only stairway serving the building (or part of the building), then the machine room should be located outside the stairway, if it cannot be sited above the lift well.

1.9.9.7 Feature Lifts

Lifts such as wall climber or feature lifts, which rise within a large volume such as a mall or atrium and do not have a conventional well, may be a risk if they run through a smoke reservoir. In this case, care is needed to maintain the integrity of the smoke reservoir and protect the occupants of the lift.

1.9.9.8 Evacuation Lifts

In general, it is not appropriate to use lifts when there is a fire in the building because there is always the danger of the lift becoming immobilised as a result of the fire, and of persons being trapped inside.

However, in some circumstances a lift may be needed as part of a management plan for evacuating people with disabilities. In such cases the lift installation needs to be appropriately sited and protected, and needs to contain a number of safety features that are intended to ensure that the lift may remain usable for evacuation purposes during the fire.

1.9.9.8.1 Requirements for Evacuation Lifts

An evacuation lift, where provided, should be designed and installed in accordance with the relevant provisions in I.S. EN 81-20 and I.S. EN 81-70.

An evacuation lift should:

- (a) be situated within a protected enclosure consisting of the lift well itself; and
- (b) be accessed via a protected lobby at each storey served by the lift; and
- (c) discharge to a protected lobby / corridor at final exit level, which leads directly to a final exit; and
- (d) be associated with a refuge (see [Para 1.9.14](#)), which should be clearly identified.

No part of an escape route should be served only via an evacuation lift.

Section 1: Means of Warning and Escape in Case of Fire

In some cases, firefighters' lifts (which are provided principally for the use of the fire and rescue service in fighting fires) may be installed at locations within the building that enable them to augment the evacuation strategy for persons with disabilities. If so located, these lifts may be used for evacuation of those occupants prior to the arrival of the fire and rescue service, provided that the associated firefighting shaft includes a refuge area (see [Para 1.9.14](#)).

An evacuation lift should be provided with an alternative power supply, which is capable of operating the lift at all material times.

1.9.10 Electrical Installations and Protected Circuits

Ireland's National Rules for Electrical Installations, I.S. 10101, includes requirements for design and installation of all types of installations, including housing, hospitals, agricultural buildings, caravans, construction sites, industrial premises and swimming pools. The Commission on Regulation of Utilities (CRU) is the body responsible for regulating restricted and controlled electrical works. This paragraph specifies additional provisions with respect to fire-safety matters applicable to the protection of means of escape in buildings.

Distribution boards housed in stairways or protected corridors should be housed in lockable fire-resisting enclosures (see [Appendix A, Table 31](#)).

Where an electrical transformer or substation room and any associated main switch room are to be provided in a building, they should be located on the perimeter of the building that has an external-access door.

1.9.11 Refuse Chutes and Storage

Refuse storage chambers, refuse chutes and refuse hoppers should be sited and constructed in accordance with BS 5906.

Refuse chutes and rooms provided for the storage of refuse should:

- (a) be separated from other parts of the building with fire-resisting construction (see [Section 3](#)); and
- (b) not be located within protected stairways or protected lobbies.

Rooms containing refuse chutes, or provided for the storage of refuse, should be approached only by way of a protected lobby provided with not less than 0.2 m² of permanent ventilation, to the outside of the building.

Access to refuse storage chambers should not be sited adjacent to escape routes or final exits or near to windows of flats.

Section 1: Means of Warning and Escape in Case of Fire

1.9.12 Fire Safety Signs

Signs to indicate escape routes, including any doorways or exits which provide access to the means of escape, are required in all buildings to which this document applies. They should be illuminated by means of natural lighting, artificial lighting or by emergency escape lighting, as appropriate (see [Para 1.9.8](#)), so that they are clearly visible and distinguishable by the occupants of a building.

Signs should be provided to indicate the position of fixed hose reels (see [Para 1.9.15](#)) and fire-alarm call points (see [Para 1.9.13](#)), where provided.

Signs should be provided on fire doors in accordance with [Appendix B](#). Signs to fire doors should conform to [Diagram 86](#). Fire doors in normal operation should indicate that they should be kept shut. Fire doors held open by electromagnetic devices connected to the fire alarm should indicate that they are automatic fire doors and to keep clear. Fire doors to service risers should indicate that they should be kept locked shut.

Where doors on escape routes are required to be fitted with push bar mechanisms (see [Para 1.9.3](#)), a fire safety sign in accordance with Annex A, A19 of I.S. EN 1125 should be provided.

Signs should be provided at each refuge area (see [Para 1.9.14](#)) clearly indicating the floor number, and the stairway number, where more than one stairway is provided.

Further information with respect to signs is contained within I.S. EN ISO 7010.

In a building containing flats, fire safety signs are not required in individual dwellings.

Other signs, which may be required when the building is in use, are outside the scope of the Building Regulations.

1.9.13 Fire Detection and Alarm Systems

1.9.13.1 Introduction

The occurrence of fire in a building could lead to a situation where conditions become untenable and escape routes become unusable. It is likely that these conditions will not occur until sometime after the initiation of the fire, and the sooner the outbreak is detected, the more time will be available for evacuation.

Buildings should be provided with a fire detection and alarm system to warn the occupants of the existence of fire where the building is of such a size, layout or occupancy that the fire itself may not provide adequate warning to the occupants so as to enable them to escape safely.

Section 1: Means of Warning and Escape in Case of Fire

Fire detection and alarm systems should be provided in accordance with the provisions indicated in [Table 12](#), except in buildings which conform to [Para 1.9.13.1.1](#). In addition to the minimum requirements set out under [Table 12](#), consideration should be given to the provision of additional detection in a place of special fire risk, (L2/L3) where a fire in such a place may affect an escape route from the building.

The provisions for fire detection and alarm systems as set out in [Table 12](#) should be designed and installed in accordance with I.S. 3218.

The fire detection and alarm system should be designed to ensure that sufficient warning by means of sounders is provided to all building occupants, including any rooftop areas. Sounders should meet the requirements of I.S. EN 54-3.

1.9.13.1.1 Premises Where Fire Alarms May Not Be Required

In certain circumstances, the size, layout or use of the building may be such that the occurrence of a fire in any part of the building is readily observed, and a fire detection and alarm system may therefore not be required. In general, these buildings are single-storey, of limited size, with no sleeping risk, and with all areas capable of being readily observed. Where a room serves as an access room, the inner room should meet the requirements of [Para 1.4.3.4](#).

1.9.13.2 Mixed-Use Buildings or Buildings with Multiple Occupancies

An automatic fire detection and alarm system should be provided in buildings which contain a number of different uses, or different occupancies which share an escape route (see [Para 1.4.3.9](#)).

The type of system and the degree of protection provided to each use or occupancy should be in accordance with [Table 12](#). Individual systems should be interlinked (commonly referenced with an 'X' classification, e.g. L3X) to provide adequate warning, in the event of fire, to all areas sharing an escape route.

1.9.13.3 Buildings Containing Flats or Maisonettes

In a building containing flats or maisonettes (Purpose Group 1(c)), individual dwellings should be provided with a fire detection and alarm system complying with the provisions set out in [Para 1.9.13.3.2](#).

In addition to the domestic alarm system, in a building containing flats, where the flats are accessed by common protected corridors / lobbies / stairways, a common fire detection and alarm system should be provided in accordance with [Para 1.9.13.3.1](#).

Section 1: Means of Warning and Escape in Case of Fire

Table 12 Provision of Fire Detection and Alarm System		Para 1.9.13
Purpose Group ⁽⁴⁾	System coverage area ⁽¹⁾	System Classification
1c,	Defined escape routes, in common protected areas (see Para 1.9.13.3.1) ⁽²⁾ In individual flats (see Para 1.9.13.3.2) ⁽³⁾	L3X Grade D LD2
2a, 2b	Coverage to all areas	L1
Hospitals	See HTM 05/03	L1
Small guest houses (Para 1.5.8.2)	See Para 1.9.13.3.2	Grade D LD2
3, 4a, 8	Defined escape routes, areas off defined escape routes.	L3
4b	Defined escape routes, areas off defined escape routes, interconnected alarm systems in different occupancies.	L3X
5a, 5b, 6a, 6b, 7a, 7b	Defined escape routes, areas off defined escape routes, places of special fire risk.	L2/L3
7c	Defined escape routes, areas off defined escape routes undefined escape routes.	L3
Notes: <ul style="list-style-type: none"> (1) Manual call points should be provided in addition to any automatic fire detection and alarm system specified (L1 – L3), in accordance with I.S. 3218, or equivalent. (2) This system should not be connected to any alarms within individual dwellings. (3) Individual flats only. (4) Where any building has an atrium configuration (see Para 3.8.3) and there is no fire/separation between the atrium and the adjoining spaces, the fire detection and alarm system should be provided in the following areas: defined escape routes, areas off defined escape routes, places of special fire risk, unless the building requires a higher level of system. 		

1.9.13.3.1 Fire Detection and Alarm System in Common Areas of Flats

A fire detection and alarm system provided to a building containing flats should be designed to provide adequate warning in the case of fire. This system should not be connected to any alarms within individual dwellings provided in accordance with [Para 1.9.13.3.2](#).

It should consist of:

- (a) a heat detector in each flat, located adjacent to the entrance door to the flat (In the case of a maisonette, a heat detector should be provided in the stairway enclosure, at every storey level); and
- (b) a sounder in each flat, meeting the requirements of I.S. EN 54-3, located in the circulation area, not more than 5 m from any bedroom door; and
- (c) smoke detectors and sounders in any common enclosed protected escape route; and
- (d) smoke or heat detectors (as appropriate) in ancillary accommodation.

Section 1: Means of Warning and Escape in Case of Fire

1.9.13.3.2 Fire Detection and Alarm System in Individual Flats

Flats and maisonettes should be provided with a Grade D system, which consists of an installation of self-contained mains-powered smoke or heat alarms, each provided with an integral standby power supply. Where multiple units are provided, all devices shall be interconnected so that detection of fire by any one unit will provide an audible alarm from each unit.

For Grade D installations, interconnections may be by wiring or radio. Where radio interconnection is used, the manufacturer's recommendations on testing of signal strength/reception at each device shall be carefully followed and records kept.

Category LD2: Interconnected self-contained mains powered/battery backed Smoke/Heat Alarms (as Grade D above) should be suitably located in:

- (a) all circulation areas that form part of an escape route within the flat/maisonette;
- (b) all high-fire-risk areas/rooms, e.g. kitchens, living rooms, utility rooms; and
- (c) all bedrooms.

Smoke detectors should be to I.S. EN 14604.

1.9.13.4 Buildings Containing Atria

The associated floor areas of an atrium should be provided with detection to the following areas: defined escape routes, areas off defined escape routes, places of special fire risk, unless the use of the building requires a higher level of detection, e.g. provision of a fire detection and alarm system to all areas.

Areas separated from the atrium by means of fire-resisting and smoke-retarding construction meeting the requirements of fire resistance for the particular structure (see [Appendix A](#), [Table 31](#) and [Table 32](#)) should be provided with a system of detection and alarm appropriate to the equivalent non-atrium building as per [Table 12](#).

In spaces where smoke control arrangements are used, the fire alarm system should be zoned in accordance with the smoke control zoning arrangements (see [Section 6](#)).

Section 1: Means of Warning and Escape in Case of Fire

1.9.14 Provision of Refuge Areas in Buildings

The principles underlying the design of the means of escape from a building are based on the assumption that in the event of an outbreak of fire it may be necessary to evacuate all or part of a building. The provision of escape routes applies to all occupants who may use a room or storey, irrespective of ability. Normally, the evacuation will ultimately be to a place of safety outside the building, but in some cases it may be necessary to initially evacuate to a place of relative safety within the building.

The required number of escape routes from a room or storey is set out under [Para 1.4.2](#).

A refuge is a place of relative safety within a building that is separated by fire-resisting construction and provided with a safe route to a storey exit. People can use a refuge to await assistance for evacuation or as a location to rest in while evacuating.

Such a refuge area may typically be used by persons with disabilities, but should be available to all persons who may require its use.

A refuge area should be provided to each protected stairway designed for means of escape from each storey, and to each external escape stairs. This applies irrespective of the provision of a lift.

1.9.14.1 Provision of Refuge Areas

A refuge area should be provided in every building to which this section applies. A minimum of one refuge area per stairway, per floor, whether at, above, or below ground level, should be provided.

Such a refuge should be located:

- (a) within the enclosure to a protected stairway, (see [Diagram 39](#) (a and b)); or
- (b) within a protected lobby that has direct access to a protected stairway or external escape stairway (see [Diagram 39](#) (c)); or
- (c) in an adjoining compartment (see [Diagram 40](#), see Appendix A, [Table 31, Item 8](#)) (excluding buildings containing flats) provided that:
 - (i) there is more than one route to access the adjoining compartment, available to all occupants; and
 - (ii) each compartment is provided with direct access to a storey exit; or
- (d) on the landing to an external escape stairway (see [Diagram 41](#)). Any wall adjacent to the refuge, and within 1.8m (horizontally and vertically above the refuge) should be fire resisting. Any door in the external wall should be fire resisting (see [Appendix B](#)). The external escape stairway should conform to the provisions of [Para 1.5.9](#); or
- (e) in an area in the open air such as a flat roof, common deck, podium or similar place which is sufficiently protected (or remote) from any fire risk, and provided with its own means of escape.

Section 1: Means of Warning and Escape in Case of Fire

1.9.14.2 General Requirements for Refuge Areas

Each refuge area should conform to each of the following

- (a) Be provided with a permanently marked zone of at least 0.9 m x 1.4 m; and
- (b) Be clearly identified by appropriate fire safety signs (Where a refuge is in a lobby or stairway the sign should be accompanied by a blue sign worded “Refuge Area – Keep clear”); and
- (c) Be provided with an emergency voice communication (EVC) system (see [Para 1.9.14.5](#)); and
- (d) Be enclosed in an area of fire resisting construction (see Appendix A, [Table 31](#), Item 14) (excluding a refuge to which Para 1.9.14.1 (c) (d) and (e) relates); and
- (e) Not reduce the effective width of the required escape route, whether located in a stairway, in a lobby or on an external escape route.

Where a refuge area is located within a stairway, access to the area can either be against the flow of occupants escaping upper storeys (see [Diagram 39](#) (a)) or with the flow of occupants escaping upper storeys (see [Diagram 39](#) (b)). Where access to the refuge is against the flow, the route to the refuge area should not interfere with the escape route from upper storeys.

In a residential (other) building (Purpose Group 2(b)), the refuge should not be located in a protected corridor to which bedrooms have direct access.

Where a refuge area is located within a pressurized stairway, special consideration should be given to the requirements for door opening.

1.9.14.3 Refuge Areas in Buildings Containing Flats

A refuge area should be provided in buildings containing flats, to which this section applies.

A refuge area in buildings containing flats should be provided in a place of relative safety, within the enclosure of a common protected stairway, or within any protected corridor / lobby, adjacent to the stairway. This protected corridor / lobby should not provide direct access to a flat or to ancillary accommodation and should provide direct access to the stairway.

Section 1: Means of Warning and Escape in Case of Fire

1.9.14.4 Escape in Places of Assembly

In buildings containing stepped audience and spectator facilities, the design for means of escape should provide persons with wheeled mobility devices with a choice of alternative exits from the room, similar to that enjoyed by ambulant persons.

1.9.14.5 Communications

To facilitate the effective evacuation of people from a refuge area an emergency voice communication (EVC) system should be provided. It is essential that the occupants of each refuge area are able to let other people know that they are in need of assistance, and for them to be reassured that this assistance will be forthcoming.

The EVC system should comply with BS 5839-9 and consist of Type B outstations which communicate with a master station located in the building control room (where one exists) / control point, adjacent to the fire alarm panel, or at fire-service access level.

1.9.15 Fixed Hose Reels

First-aid firefighting equipment is provided in buildings to be used by the occupants, with appropriate training and where it is safe to do so, in the early stages in the development of a fire.

A hose reel consists of a length of tubing fitted with a shut-off nozzle and attached to a reel, with a permanent connection to a pressurised water supply.

Hose reels should be provided in a building, where the floor area exceeds 500 m², which is used:

- (a) as a shop (Purpose Group 4(a)); or
- (b) as a shopping centre (Purpose Group 4(b)); or
- (c) for industrial (Purpose Group 6(a), or 6(b)) purposes; or
- (d) for storage (Purpose Group 7(a), 7(b), or 7(c)).

The installation of hose reels should comply with the relevant provisions of I.S. EN 671-1.

While portable fire extinguishers may be required under other legislation, their provision is excluded from the requirements of the Building Regulations.

1.9.16 Heat-Producing Appliances

Any heat-producing appliance can provide a source of ignition for fires in buildings. The location of appliances in relation to escape routes should therefore be considered.

Part J of the Second Schedule to the Building Regulations contains requirements in relation to heat-producing appliances.

Diagram 39 Refuge Area Placed in a Protected Stairway

Para 1.9.14.1

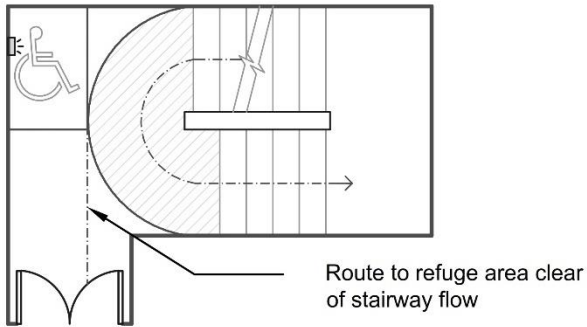

(a) Refuge in protected stairway, where access to the wheelchair space is counter (contra-flow) to the escape flow within the stairway

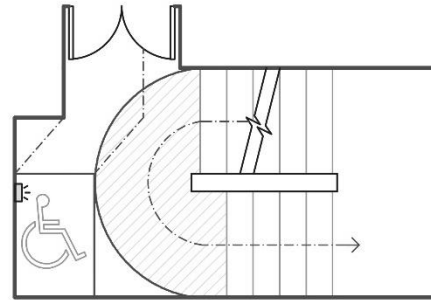



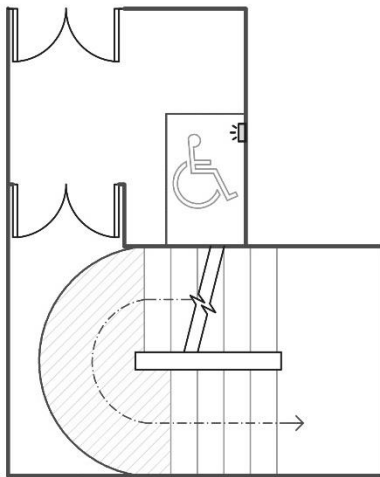

(b) Refuge in protected stairway, where access to the wheelchair space is in the same direction as the escape flow within the stairway



(c) Refuge in protected lobby adjacent to stair

KEY

-  Fire door
-  Wheelchair space
-  Occupied by escape flow
-  Emergency Voice Communication System

Notes:

- (1) For compartmentation see [Section 3](#).
- (2) For performance of fire-resisting walls, see [Appendix A](#).
- (3) For performance of fire-resisting doors, see [Appendix B](#).

Section 1: Means of Warning and Escape in Case of Fire

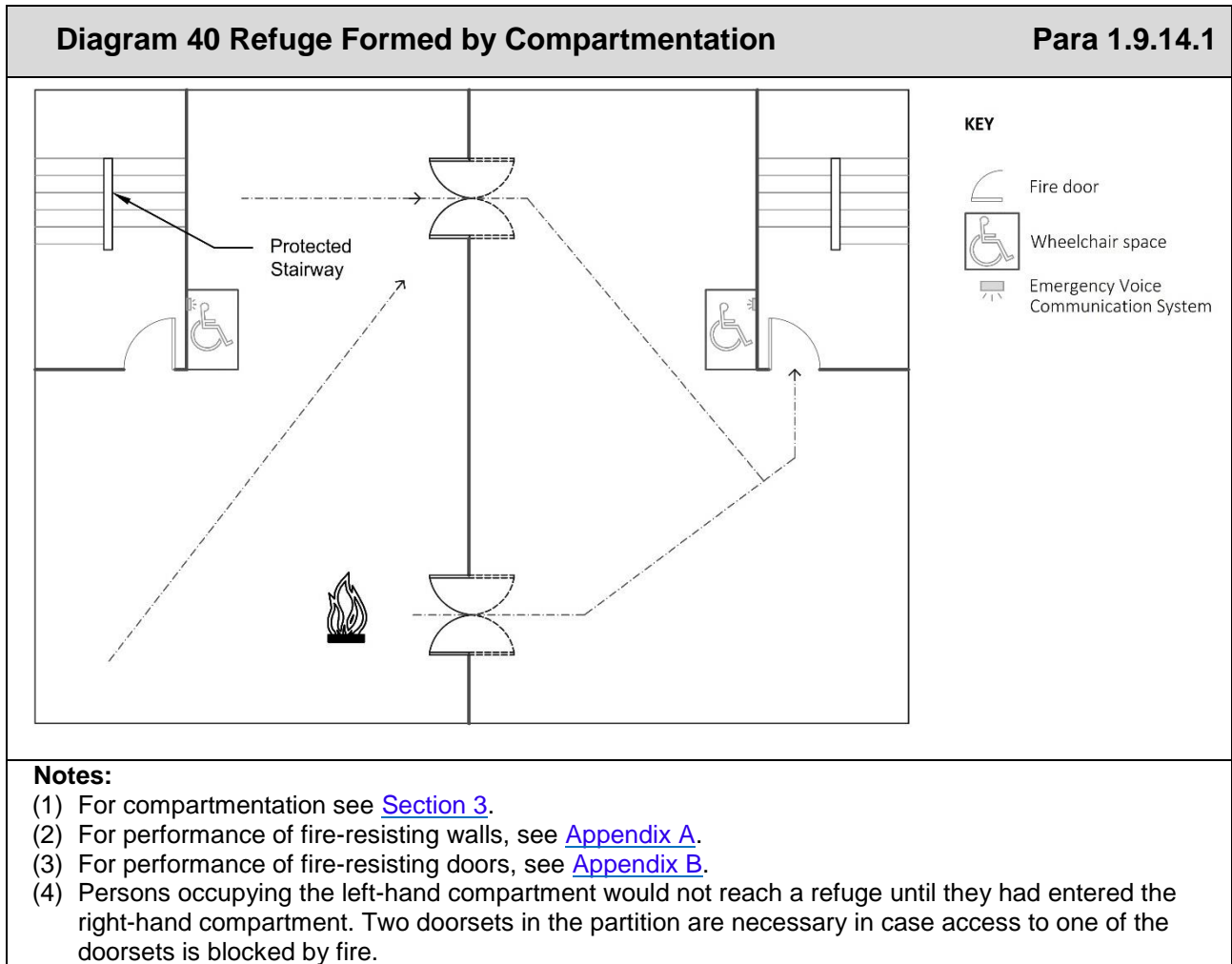
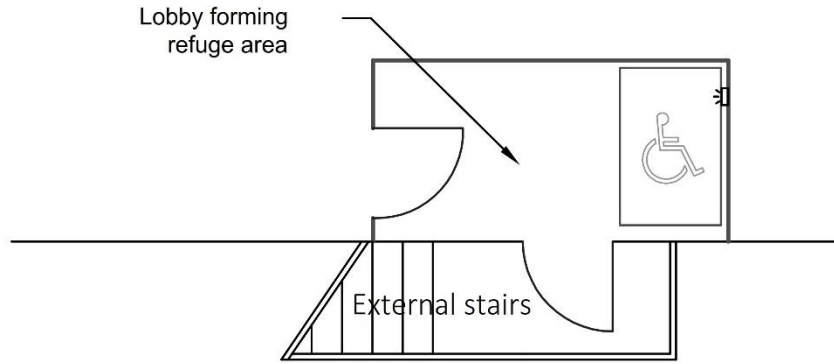
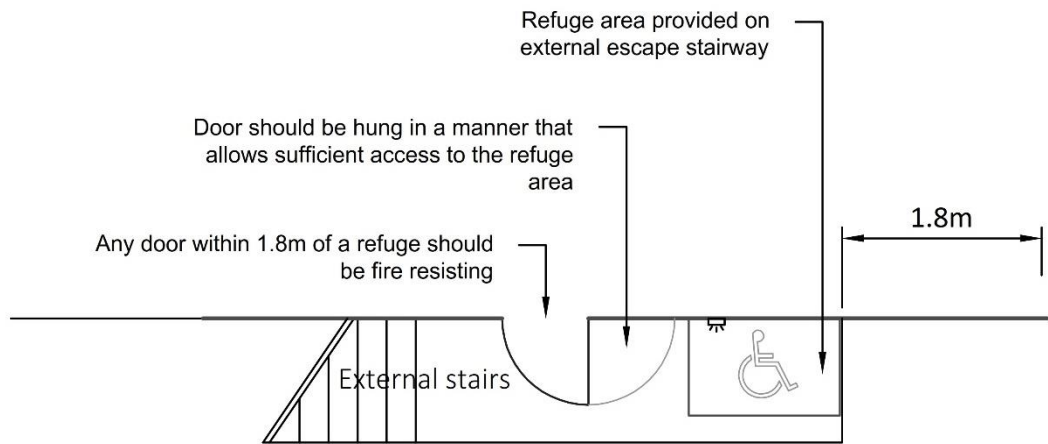

Diagram 41 Refuge on an External Escape Stairway

Para 1.9.14.1



(a) Refuge area provided in a lobby that has direct access to an external escape stair



(b) Refuge area provided on an external escape stair

Notes:

- (1) For compartmentation see [Section 3](#).
- (2) For performance of fire-resisting walls, see [Appendix A](#).
- (3) For performance of fire-resisting doors, see [Appendix B](#).

Section 2: Internal Fire Spread (Linings)

Section 2 Internal Fire Spread (Linings)

2.1 Introduction to Provisions

The guidance in this section shows compliance with Part B of the Second Schedule to the Building Regulations, in particular Regulation B2. However, limiting fire spread on surfaces also contributes to achieving adequate means of escape, outlined in [Section 1](#) (Means of Warning and Escape in Case of Fire); limited fire spread in unseen spaces, outlined in [Section 3](#) (Internal Fire Spread (Structure)); and adequate protection for firefighting, outlined in [Section 5](#) (Access and Facilities for the Fire Services).

2.1.1 Fire Spread and Lining Materials

The choice of materials for the lining of walls and ceilings can significantly affect the spread of a fire, and its rate of growth, even though they are not likely to be the materials first ignited. This is particularly important in circulation spaces where linings would offer the main vehicle for fire spread, and where rapid spread would be most likely to prevent occupants from escaping.

Several properties of lining materials influence fire spread. These include the ease of ignition and the rate at which the lining material gives off heat when burning. The guidance relating to the European fire tests and classification provides for control of internal fire spread through control of these properties.

These requirements may be achieved:

- (a) if the heat released from the internal linings is restricted by making provision for them to have a rate of fire growth and a resistance to ignition according to the European fire tests and classification system which is reasonable in the circumstances; or
- (b) if the spread of fire over the internal linings of the building is restricted by making provision for them to have low rates of surface spread of flame, and in some cases to have a low rate of heat release or a low rate of fire growth, so as to limit the contribution that the fabric of the building makes to fire growth.

The extent to which this is necessary is dependent on the location of the lining.

2.1.2 Floors in Firefighting Shafts

In the case of firefighting stairs, any material used to cover stairways should be a material achieving Class A2_{fl} –s2, or better, (see [Appendix A, A6 Reaction to Fire](#)).

Section 2: Internal Fire Spread (Linings)

2.1.3 Classification of Performance

[Appendix A](#) describes the different classes of performance for materials used as a wall or ceiling lining and the appropriate methods of test, including performance ratings for thermoplastic materials, referred to as TP (a) rigid and TP (b).

The European classifications are described in I.S. EN 13501-1, Fire classification of construction products and building elements, Part 1 - Classification using data from reaction to fire tests.

The European classifications are based on a combination of four European test methods:

- (a) I.S. EN ISO 1182: Reaction to fire tests for building products - Non combustibility test;
- (b) I.S. EN ISO 1716: Reaction to fire tests for building products - Determination of the gross heat of combustion (calorific value);
- (c) I.S. EN 13823: Reaction to fire tests for building products - Building products excluding floorings exposed to the thermal attack by a single burning item; and
- (d) I.S. EN ISO 11925-2: Reaction to fire tests for building products, Part 2 - Ignitability when subjected to direct impingement of flame.

The European classification method should always be used for building materials except where there is no generally accepted guidance on the appropriate procedure for testing and classification in accordance with the European fire tests.

For such building products, (where there is currently no generally accepted guidance on the appropriate procedure for testing and classification in accordance with the European fire tests) classification may only be possible using appropriate alternative test methods, providing a proven equivalent performance, until such time as the appropriate European method is available.

Section 2: Internal Fire Spread (Linings)

2.2 General Provisions

Subject to the exclusions, variations and specific provisions described in the paragraphs below, the surface linings of walls (including glazing) and ceilings should meet the classifications as listed in [Table 13](#).

2.2.1 Surfaces Excluded from the General Provisions

The following surfaces may be excluded from the general provisions:

- (a) doors and door frames; or
- (b) window frames and frames in which glazing is fitted; or
- (c) architraves, skirtings and facings, cover moulds, picture rails and similar narrow members; or
- (d) fireplace surrounds and mantle shelves; or
- (e) electrical switches, outlets, cover plates and similar small discontinuous areas; or
- (f) pipes and cables used to distribute power or services; or
- (g) ceiling hatches and their frames; or
- (h) frames of rooflights in which glazing is fitted.

Table 13 Reaction-to-fire Classifications		Subsection 2.2
Classification to I.S. EN 13501-1	Room / Area	
Class C - s3, d2	All purpose groups (except those listed below) ⁽¹⁾	
Class D - s3, d2	Bathrooms, toilets and shower rooms	
Class B - s3, d2	Rooms exceeding 30 m ² in:	
	(a) Residential (care facility) (Purpose Group 2(a)), and	
	(b) Assembly and recreation buildings(Purpose Group 5(a))	
	(c) Day centre buildings, (Purpose Group 5(b))	
	Circulation spaces ⁽²⁾	
	The soffit of a fire-resisting ceiling	
	Places of special fire risk (see Subsection 0.10).	
Notes:		
(1) Includes private circulation spaces in individual flats and maisonettes		
(2) Common areas of flats and maisonettes		

Section 2: Internal Fire Spread (Linings)

2.2.2 Variation and Special Provisions

2.2.2.1 Walls

Part of the surface of a wall in a room (but not in a circulation space) may be of a class lower than specified in [Subsection 2.2](#) (but not lower than Class D - s3, d2).

The area of any such part should

- (a) Be not greater than 5 m² with a combined total area of 20 m² or half the area of the room (whichever is lower) in any of following purpose groups:
 - (i) A building containing flats (Purpose Group 1 (c)); or
 - (ii) A residential (care facility) building (Purpose Group 2(a)); or
 - (iii) A residential (other) building (Purpose Group 2(b)); or
 - (iv) An assembly and recreation building (Purpose Group 5(a)); or
 - (v) A day-centre building (Purpose Groups 5 (b)).
- (b) Be not greater than 15 m² with a combined total area of 60 m² or half the floor area of the room (whichever is lower) for all other purpose groups.

In all cases, the parts must be separated by a minimum of 2 m.

2.2.2.2 Suspended Ceiling with a Fire Resistance

In addition to satisfying the general provisions set out in [Subsection 2.2](#), suspended ceilings (see [Diagram 42\(a\)](#)) that can be accepted as contributing to the fire resistance of a floor must also meet the criteria outlined in [Table 33](#) to [Appendix A](#).

This provision does not apply to floors and beams in a shopping-centre building (Purpose Group 4(b)).

2.2.2.3 Special Applications

Any flexible membrane covering a structure should comply with the recommendations given in Appendix A of BS 7157.

Guidance on the use of PTFE-based materials for tension-membrane roofs and structures is given in BR 274.

Section 2: Internal Fire Spread (Linings)

2.3 Thermoplastic Materials

Thermoplastic materials (see [Appendix A, Subsection A8](#)) which cannot meet the performance specified in [Subsection 2.2](#) can be used in windows, rooflights and lighting diffusers in ceilings if they comply with the provisions of the following paragraphs:

No guidance is currently possible on the performance requirements in the European fire tests, as there is no generally accepted test and classification procedure.

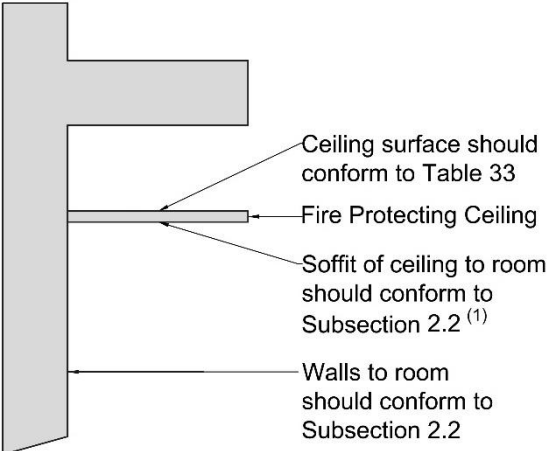
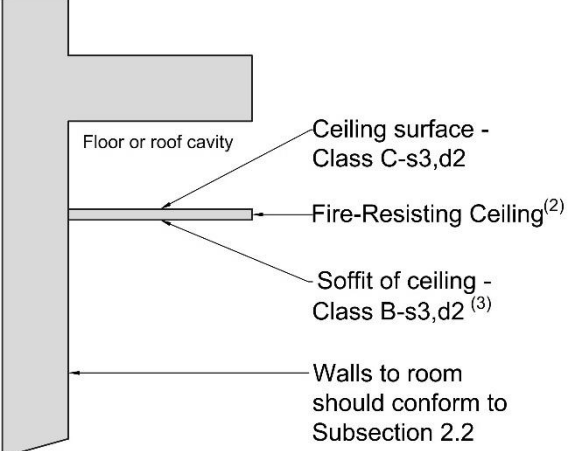
Diagram 42 Suspended Ceilings with a Fire Resistance		Para 2.2.2.2
		Para 3.6.3.1
<p>(a) Fire-protecting suspended ceiling</p>  <p>Ceiling surface should conform to Table 33</p> <p>Fire Protecting Ceiling</p> <p>Soffit of ceiling to room should conform to Subsection 2.2 ⁽¹⁾</p> <p>Walls to room should conform to Subsection 2.2</p>	<p>(b) Fire resisting ceiling</p>  <p>Floor or roof cavity</p> <p>Ceiling surface - Class C-s3,d2</p> <p>Fire-Resisting Ceiling⁽²⁾</p> <p>Soffit of ceiling - Class B-s3,d2⁽³⁾</p> <p>Walls to room should conform to Subsection 2.2</p>	
<p>(1) The fire-protecting suspended ceiling should:</p> <ul style="list-style-type: none">(a) have a fire resistance as specified under Appendix A, Table 31 and Table 32, proven under test to IS EN 1364.(b) conform to Appendix A, Subsection A6 and Table 33.	<p>(2) The fire-resisting ceiling should:</p> <ul style="list-style-type: none">(a) Have a fire resistance in accordance with Appendix A, Table 31; and(b) Be imperforate except for an opening allowed under Para 3.6.5; and(c) Extend throughout the building, compartment or separated part; and(d) Not be demountable. <p>(3) Circulation spaces (excluding circulation spaces in dwellings), and rooms exceeding 30 m² in Residential (care facility) (Purpose Group 2(a)), and Assembly and Recreation (Purpose Group 5(a) and (b)) buildings should achieve Class B – s3, d2.</p>	

Section 2: Internal Fire Spread (Linings)

2.3.1 Glazing

External windows to rooms (though not to circulation spaces including protected stairways) may be glazed with thermoplastic materials, if the material can be classified as a TP (a) rigid product.

Internal glazing made from thermoplastic material should meet the provisions in [Subsection 2.2](#). A wall does not include glazing in a door.

2.3.2 Roof lights

Rooflights to rooms and circulation spaces (with the exception of protected stairways) may be constructed of a thermoplastic material if

- (a) the lower surface has a TP(a) (rigid) or TP(b) classification (see [Appendix A, Subsection A8](#)); and
- (b) the size and disposition of the rooflights conforms to the limitations in [Table 14 Diagram 44](#) and Section 4, [Table 23](#).

2.3.3 Lighting Diffusers

Lighting diffusers are translucent or open-structured elements that allow light to pass through. They may be part of a luminaire or be used below rooflights or other sources of light. The following provisions apply only to lighting diffusers which form part of a ceiling ([Diagram 43](#) (a)) and are not concerned with diffusers of light fittings which are attached to the soffit of, or suspended beneath a ceiling (see [Diagram 43](#) (b)).

Thermoplastic lighting diffusers should not be used in fire-protecting suspended ceilings or fire-resisting ceilings, unless they have been satisfactorily tested as part of the ceiling system that is to be used to provide the appropriate fire protection.

Ceilings to rooms and circulation spaces (but not protected stairways) may incorporate thermoplastic lighting diffusers if the following provisions are observed:

- (a) Wall and ceiling surfaces exposed within the space above the suspended ceiling (other than the upper surfaces of the thermoplastic panels) should comply with the general provisions of [Subsection 2.2](#), according to the type of space below the suspended ceiling; and
- (b) If the diffusers are of classification TP (a) (rigid), there are no restrictions on their extent; and
- (c) If the diffusers are of classification TP (b), they should be limited in extent, as indicated in [Table 14](#) and [Diagram 44](#).

Thermoplastic materials which have a lesser performance than TP (b) should not be used for lighting diffusers which form part of a ceiling.

Section 2: Internal Fire Spread (Linings)

Diagram 43 Lighting Diffuser Locations in a Ceiling

Para 2.4.3

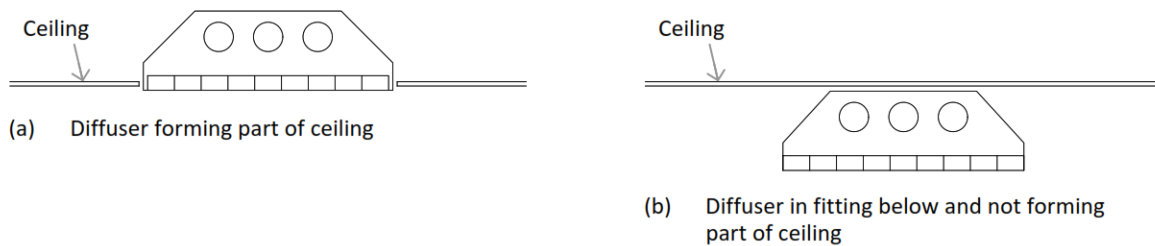
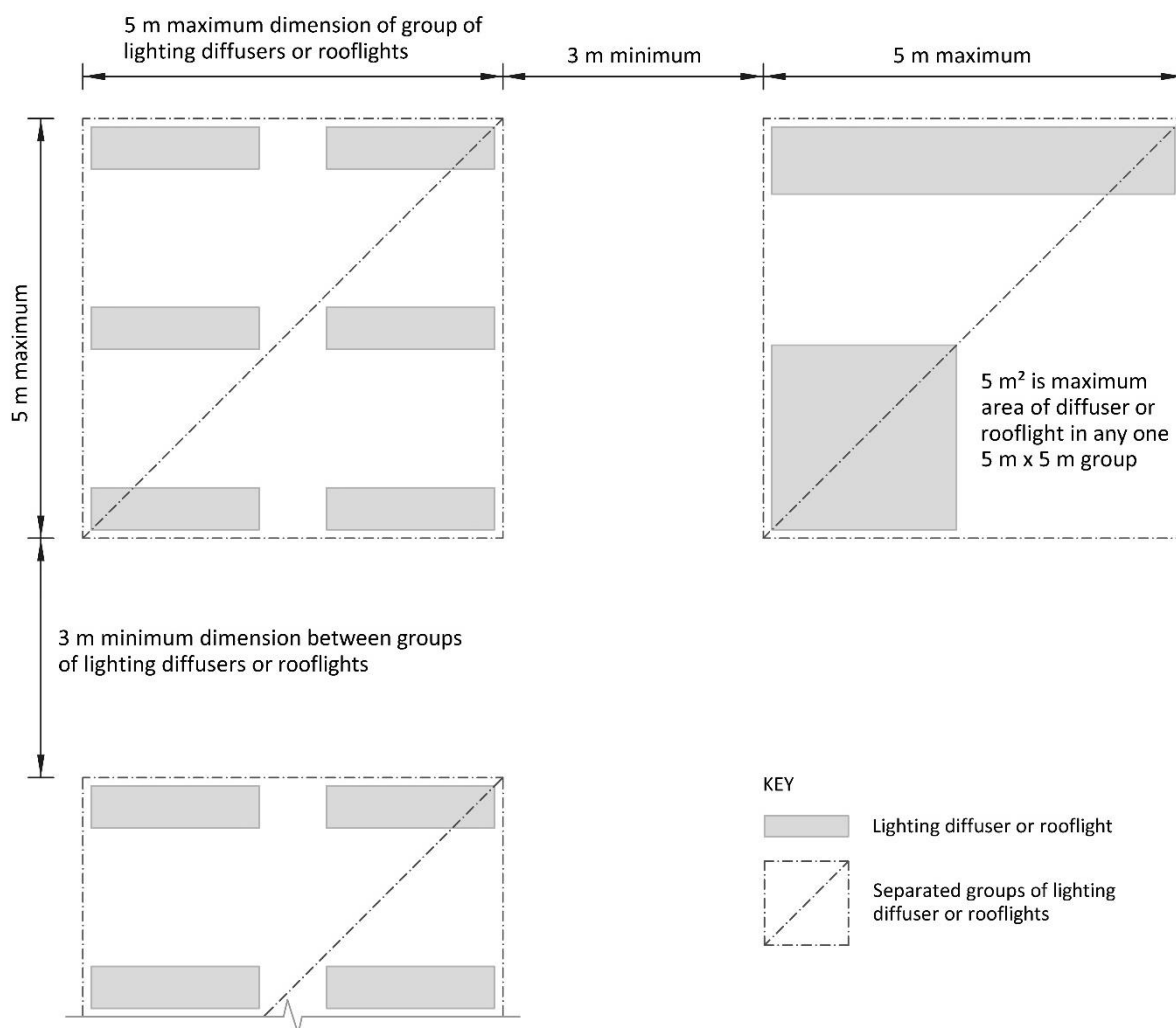

Diagram 44 Layout Restrictions on TP (b) Thermoplastic Lighting Diffusers and Rooflights



Notes:

- (1) Upper and lower surfaces of suspended ceilings between thermoplastic lighting diffusers or rooflights should comply with provisions outlined at Subsection 2.2.

Section 2: Internal Fire Spread (Linings)

Table 14 Limitations Applied to Thermoplastic Lighting Diffusers in Suspended Ceilings and Thermoplastic Roof Lights

Minimum Classification of lower surface	Use of space below the diffusers or roof lights	Maximum area of each diffuser panel or roof light ⁽¹⁾	Maximum total area of diffuser panels and roof lights (%) ⁽²⁾	Minimum distance between diffuser panels or roof lights ⁽¹⁾
TP (a) Rigid	Any ⁽³⁾	No Limit	No Limit	No Limit
TP (b)	Rooms,	5 m ²	50%	3 m
	Circulation spaces ⁽³⁾	5 m ²	15%	3 m

Notes:

- (1) Smaller panels can be grouped together, provided that the overall size of the group and the space between one group and any others satisfies the dimensions shown in [Diagram 44](#)
- (2) Percentage of floor area of the space in which the ceiling is located.
- (3) Except protected stairways.

Section 3 Internal Fire Spread (Structure)

3.1 General

The guidance in this section shows compliance with Part B of the Second Schedule to the Building Regulations, in particular Regulation B3 in order to reduce the risk of structural failure and the spread of fire, in so far as they pose a threat to the safety of people in and around the building.

Providing adequate compartmentation and inhibiting the unseen spread of fire and smoke in concealed spaces supports achieving the objectives of: adequate means of escape, outlined in [Section 1](#) (Means of Warning and Escape in Case of Fire); adequate separation between buildings and spread of fire on the face of the building, outlined in [Section 4](#) (External Fire Spread); and adequate access for firefighters, outlined in [Section 5](#) (Access and Facilities for the Fire Service).

These requirements may be achieved if:

- (a) the structural elements of the building are capable of withstanding the effects of fire for an appropriate period without loss of stability; and
- (b) the building is subdivided by elements of fire-resisting construction (which may or may not be load-bearing) into compartments; and
- (c) any openings in fire-separating elements are suitably protected in order to maintain the fire integrity of the element; and
- (d) any hidden voids in the construction are sealed and subdivided to inhibit the unseen spread of fire and products of combustion

The extent to which any of these measures are necessary is dependent on the use of the building, and in some cases on its size, and on the location of the element of construction.

3.2 Introduction to Provisions

The guidance in this section is divided into subsections related to the following:

[Subsection 3.3](#) - Provisions for Load-Bearing Elements of Structure.

[Subsection 3.4](#) - Provisions for the Subdivision of a Building into Compartments.

[Subsection 3.5](#) - Provisions for the Construction of Compartment Walls and Floors.

[Subsection 3.6](#) - Provisions for Concealed Spaces (or Cavities).

[Subsection 3.7](#) - Protection of Openings and Fire Stopping.

[Subsection 3.8](#) - Special Provisions, Which Apply to Certain Types of Buildings.

3.3 Load-Bearing Elements of Structure

3.3.1 Fire Resistance of Structural Elements

Structural elements (see [0.10 Definitions](#)) should have at least the fire resistance given in [Appendix A, Table 31](#) (see [Diagram 45](#)).

3.3.2 Application of Fire Resistance for Load-Bearing Elements

Where one element of structure supports or carries or gives stability to another, the fire resistance of the supporting element should be no less than the minimum period of fire resistance for the other element whether that other element is load-bearing or not (see [Appendix A, A4\(1\), Table 31](#) and [Table 32](#)).

There are circumstances where it may be reasonable to vary this principle, for example where:

- (a) an element of structure forms part of more than one building or compartment, in which case that element should be constructed to the standard of the greater of the relevant provisions; or
- (b) the supporting structure is in the open air and is not likely to be affected by the fire in the building.

A fire resistance will be needed if the element:

- (i) is not a load-bearing external wall (or doesn't support an external wall) but there is provision in Section 4 to limit the extent of openings and other unprotected areas in the wall; or
- (ii) is part of (or supports) a compartment wall, a separating wall; or
- (iii) supports a gallery.

For the purposes of this subsection, the ground storey of a building which has one or more basement storeys and no upper storey may be considered as single-storey. The fire resistance of the basement storeys should be that appropriate to basements.

Where (due to the slope of the ground) one side of a basement is open at ground level, giving an opportunity for smoke venting and access for firefighting, it may be appropriate to adopt, for elements of structure in that storey, the standard of fire resistance applicable to above-ground structures.

Where an element of structure is required to incorporate materials with a given reaction-to-fire classification, the supporting or stabilising element should incorporate materials with an equal or better reaction-to-fire classification while also ensuring adequate fire resistance of the element is achieved in accordance with [Appendix A, Table 31](#) (see [Diagram 45](#)).

Section 3: Internal Fire Spread (Structure)

3.3.3 Exclusions from the Provisions for Fire Resistance

The following are excluded from the requirements for fire resistance:

- (a) the roof structure that supports the roof weathering system, unless the roof performs the function of:
 - (i) a floor, e.g. for parking vehicles; or
 - (ii) a means of escape (see [Section 1](#)); or
 - (iii) or is essential for the stability of an external wall which is required to have fire resistance (see [Section 4](#)); or
- (b) the lowest floor of the building; or
- (c) a platform floor (access or raised floor); or
- (d) A loading gallery, fly gallery, stage grid, lighting bridge or any gallery provided for similar purposes or for maintenance and repair; or
- (e) External walls, such as curtain walls or other forms of cladding, which transmit only self-weight and wind loads and do not transmit floor load.

3.3.4 Additional Provisions for Load-Bearing Elements

Provisions for fire resistance — integrity and insulation as well as stability — are required if a load-bearing wall is also

- (a) a compartment wall (see [Subsection 3.4](#)); or
- (b) protecting a means of escape (see [Para 1.9.2](#)); or
- (c) an external wall (see [Subsection 4.3](#) and [Subsection 4.4](#)); or
- (d) enclosing a firefighting shaft (see [Subsection 5.5](#)).

If a floor is also a compartment floor, additional provisions of integrity and insulation etc. will apply (see [Subsection 3.4](#)).

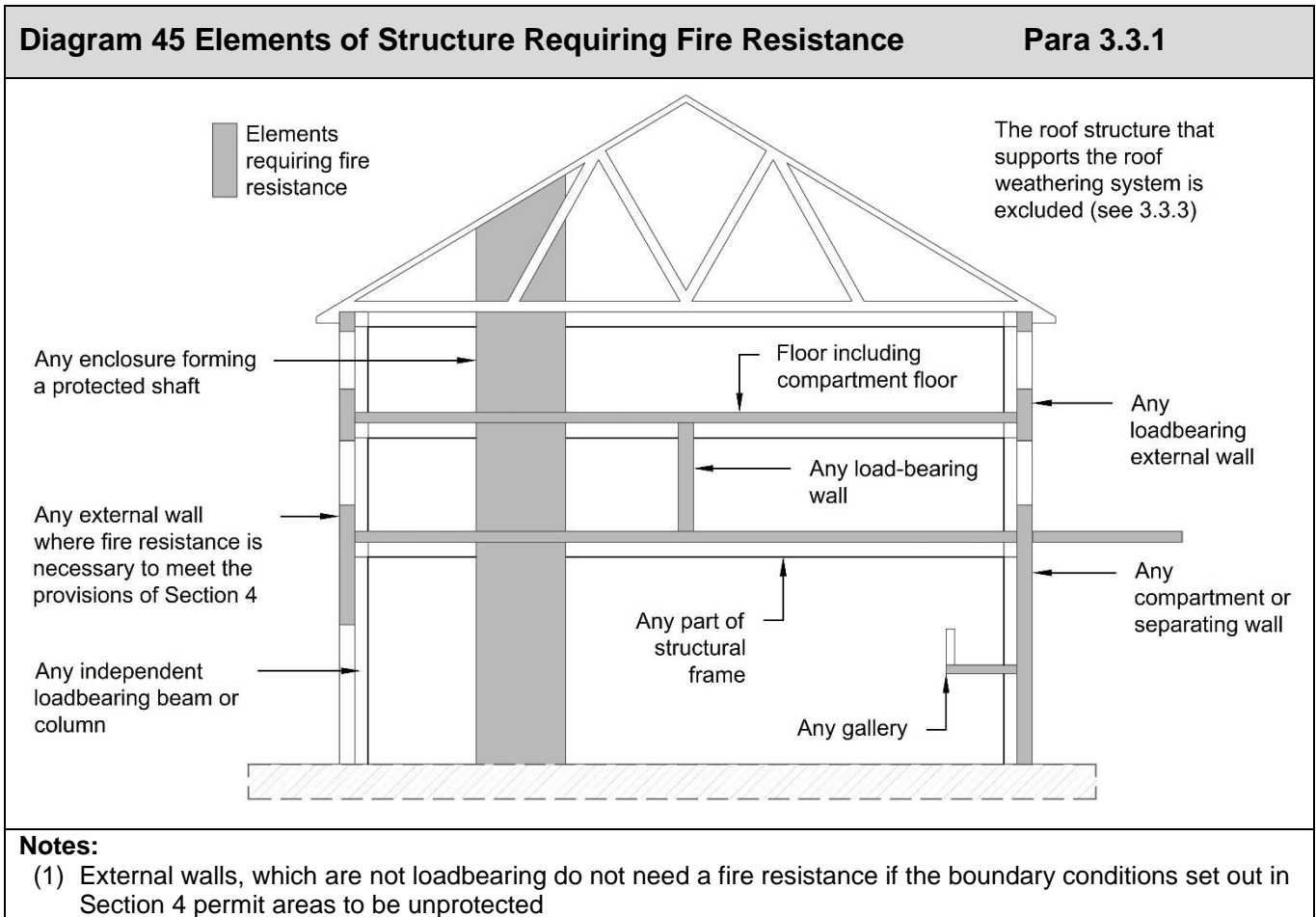

3.3.5 Raised Storage Areas in Industrial or Storage Buildings

Raised floors are frequently erected in single-storey industrial (Purpose Group 6(a) or (b)), or storage (Purpose Group 7(a) or (b)) buildings. Deepening on the purpose, and size of the gallery area, a fire resistance of the gallery floor and supporting structure may be required (see Para 3.3.5.1 or 3.3.5.2 as appropriate).

3.3.5.1 Gallery Areas Requiring Fire Resistance

Whether the area is considered as a gallery, or is of sufficient size that it is considered as a floor forming an additional storey, the structure forming the gallery should comply with the provisions for fire resistance of elements of structure as set out in [Appendix A, Table 31](#). For provision of compartmentation for ancillary uses, see 0.5 (d).

Section 3: Internal Fire Spread (Structure)

3.3.5.2 Gallery Storage or Plant Areas which do not need Fire Resistance

In certain circumstances, galleries used for storage, or for plant do not have to meet the provision of [Para 3.3.5.1](#) if they satisfy one of the following:

- (a) They are automated storage systems in which people do not normally go onto any of the raised storage tiers; or
- (b) The gallery contains plant only, which is not an area of high fire risk, and access is for servicing or maintenance purposes only; or
- (c) Where people can go onto the storage or plant tiers in the course of their normal use, fire resistance of the raised storage area is not required if all the following conditions are satisfied:
 - (i) the structure has only one tier and is used for storage purposes or access to plant or machinery only; and
 - (ii) the number of persons likely to be on the floor at any one time is low and does not include members of the public; and
 - (iii) at least one stairway serving the raised floor, platform or tier discharges within 3 m of an exit from the building; and
 - (iv) a fire detection and alarm system is provided (see [Para 1.9.13](#)); and
 - (v) the raised storage area does not exceed 20 m in either width or length.

For provision of compartmentation for ancillary uses, see [Subsection 0.5](#) (d).

3.4 Compartmentation

3.4.1 Introduction

The spread of fire between adjoining buildings or within a building can be restricted by subdividing the structure into compartments separated from one another by walls and/or floors of fire-resisting construction.

3.4.2 Forms of Compartmentation

Subdivision within a building is achieved using compartment walls and compartment floors. Certain walls can be designed to divide a building into separated parts (in which the parts can be assessed independently for the purpose of determining the appropriate standard of fire resistance).

Subdivision between adjoining buildings is achieved by the provision of a separating wall to which particular construction provisions apply.

3.4.3 Compartment Junctions

For compartmentation to be effective, there should be continuity at the junctions of the fire-resisting elements enclosing a compartment, and any openings from one compartment to another should not present a weakness.

3.4.4 Provision of Compartment Walls and Compartment Floors

Compartment walls and compartment floors should be provided in the circumstances described in Para's 3.4.4.1 to 3.4.4.6 below, with the provision that the lowest floor in a structure does not need to be constructed as a compartment floor.

[Diagram 46](#) illustrates schematically various forms of compartmentation and indicates the paragraph references for the relevant guidance.

3.4.4.1 All Purpose Groups

The following guidance applies to all buildings and all purpose groups (see [Table 1](#)):

- (a) A wall common to two or more buildings (separating wall) should be constructed as a compartment wall; and
- (b) Compartment walls and/or compartment floors should be provided to subdivide parts of a building that are occupied mainly for different uses (see [Subsection 0.5](#) and [Table 1](#)) from one another; and
- (c) Where part of a building is used for a purpose that is ancillary to another purpose (see [Subsection 0.5](#)), it need not be separated by compartment walls and/or floors, unless that part is a place of special fire risk (see [Subsection 0.10](#)); and
- (d) Compartment walls and/or floors should be provided to separate places of special fire risk (see [Subsection 0.10](#)) from other parts of a building.

Section 3: Internal Fire Spread (Structure)

Diagram 46 Compartment Walls and Compartment Floors

Para 3.4.4

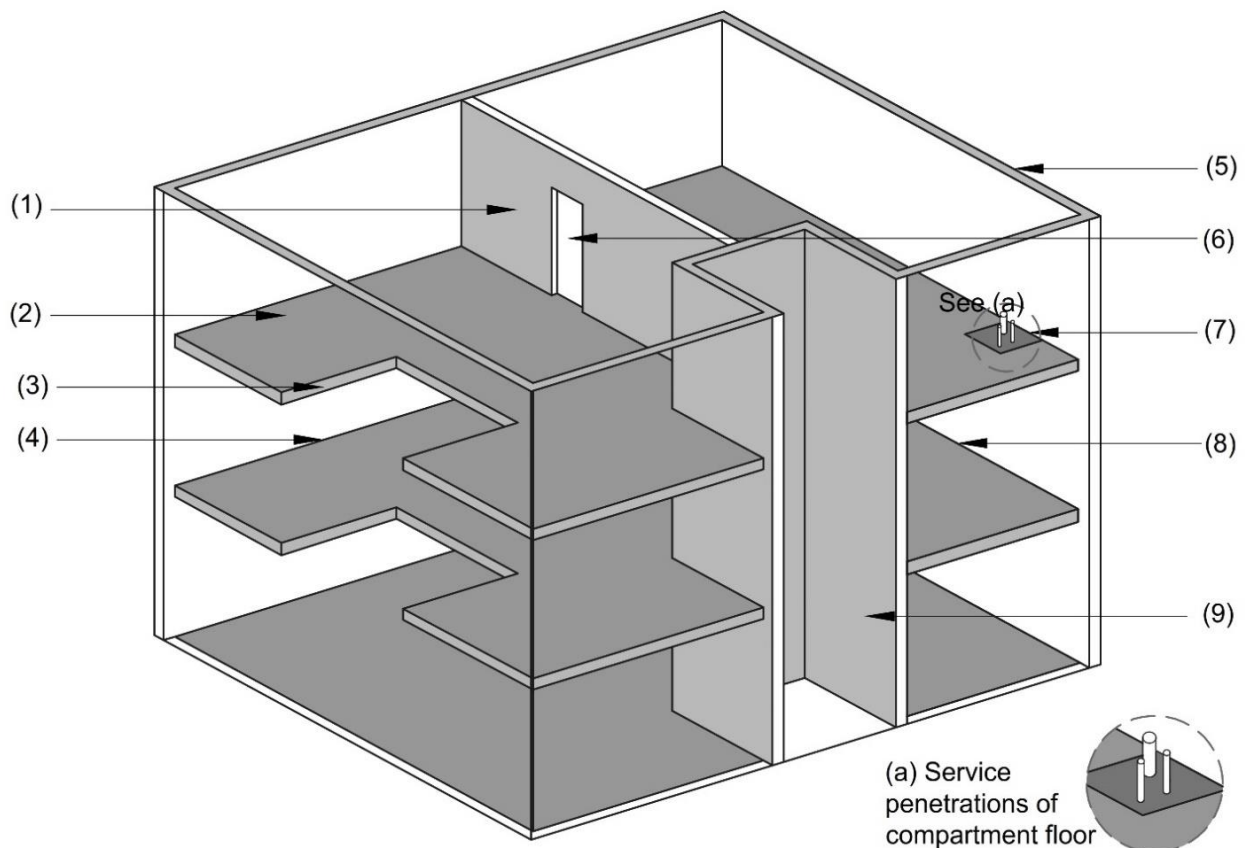

Notes:

- (1) Compartment walls (see [Subsection 3.5](#))
- (2) Compartment floors (see [Subsection 3.5](#))
- (3) Openings in compartment floors – atria (see [Para 3.5.15.3](#))
- (4) Junction of compartment floor and external wall (see [Diagram 45](#), [Para 3.5.10](#), [Diagram 48](#))
- (5) Junction of compartment wall with roof (see [Para 3.5.13](#))
- (6) Openings in compartment walls (see [Para 3.5.15](#))
- (7) Service penetrations (see [Subsection 3.7](#)). Subsection 3.7 also applies to fire-resisting construction
- (8) Junction of compartment wall and floor (see [Para 3.5.9](#))
- (9) Protected shafts (see [Para 3.5.16](#), [Diagram 51](#))

3.4.4.2 Flats and Maisonettes

In buildings containing flats (Purpose Group 1(c)), the following should be constructed as compartment walls or compartment floors:

- (a) any floor (unless it is within a maisonette, i.e. between one storey and another within one dwelling); or
- (b) any wall separating a flat from any other part of the building; or
- (c) any wall separating a refuse-storage chamber from any other part of the building; or
- (d) any wall separating ancillary accommodation from a common escape route serving flats.

Section 3: Internal Fire Spread (Structure)

3.4.4.3 Residential (Care facility) Buildings

In residential (care facility) buildings (Purpose Group 2(a)), the following should be constructed as compartment walls or compartment floors:

- (a) any floor, other than the floor of the lowest storey; or
- (b) any wall needed to subdivide a storey to observe the limits for compartment sizes outlined in [Table 15](#); or
- (c) any wall needed to subdivide a storey into at least two compartments for the purpose of progressive horizontal evacuation (see [Para 1.4.5](#)); or
- (d) the enclosure to a kitchen; or
- (e) the enclosure to any laundry room; or
- (f) the enclosure to any plant rooms.

In hospital buildings (Purpose Group 2(a) (i)), HTM 05-02 may identify specific areas of ancillary accommodation that are regarded as places of special fire risk. These areas should also be separated by way of compartmentation in accordance with the recommendations contained in that document.

3.4.4.4 Other Residential Buildings

In residential (other) (Purpose Group 2 (b)) buildings, the following should be constructed as compartment walls or compartment floors:

- (a) Any floor other than the floor of the lowest storey.
- (b) Any wall needed to subdivide a storey to observe the limits for compartment sizes outlined in [Table 15](#).
- (c) Any wall separating a unit of student accommodation ([Para 1.4.9](#)) from any other part of the building.

Section 3: Internal Fire Spread (Structure)

3.4.4.5 Non-Residential Buildings

In non-residential buildings (office, shop, shopping centre, assembly and recreation, industrial, storage and other non-residential) (Purpose Groups 3 to 8), the following should be constructed as compartment walls or compartment floors (see [Diagram 46](#)):

- (a) any wall/floor needed to subdivide the building to observe the size limits on compartments given in [Table 15](#); or
- (b) every floor; if the building, or separated part of the building, has a storey with a floor at a height of more than 30m above ground level (see [Diagram 47](#)); or
- (c) the floor of the ground storey if the building has one or more basements, excluding a ground floor in a small premises (see [Subsection 1.8](#)); or
- (d) any basement floor, if the building, or separated part, has a basement at a depth of more than 10m below ground level; or
- (e) any refuse storage areas in a shop or office building (Purpose Group 3 or 4(a)); or
- (f) in the case of a shopping centre building, any walls or floors required to comply with the provisions outlined in [Para 3.4.4.6](#).

Section 3: Internal Fire Spread (Structure)

Table 15 Maximum Area and Cubic Capacity of a Building or Compartment Para 3.4.4				
Use	Purpose Group	Building form	Maximum floor area ⁽¹⁾ of any one storey in the building or of any one storey in a compartment (m ²)	Maximum cubic capacity ⁽¹⁾ of building or compartment (m ³)
Residential (dwellings)	1(c)	Any	No limit	No limit
Residential (care facility) ⁽⁵⁾	2(a)	(a) single storey (b) > one storey	3,000 ⁽²⁾ 1,500 ⁽³⁾	No limit ⁽³⁾
Other residential	2(b)	(a) single storey (b) > one storey	No limit 2,000 ⁽³⁾	No limit No limit ⁽³⁾
Office	3	(a) single storey (b) > one storey	No limit 4,600	No limit 28,000
Shop	4(a)	Single storey (unsprinklered) Single storey (sprinklered) > one storey (unsprinklered) > one storey (sprinklered)	2,000 8,000 2,000 5,600	No Limit No Limit 7,100 14,200
Shopping Centre	4(b)	Any	See Para 3.4.4.6	No limit
Assembly and recreation, Day Centre, Other non-residential	5(a), 5(b), 8	(a) single storey (b) > one storey	No limit 1,900	No limit 21,000
Industrial ⁽⁶⁾	6(a) Normal Hazard	(a) single storey (b) > one storey	93,000 7,500	No limit No limit
	6(b) High Hazard	(a) single storey (b) > one storey	33,000 2,800	No limit 17,000
Storage ⁽⁶⁾⁽⁷⁾	7(a) Normal Hazard	(a) single storey (b) > one storey	14,000 2,800	No limit 21,000
	7(b) High Hazard	(a) single storey (b) > one storey	1,000 500	No Limit 4,200
	7(c)	Car park	No limit	No limit

Notes:

- (1) Other factors may also determine the provision of compartment walls and floors (see [Para 3.5.4](#)).
- (2) For buildings of any purpose groups, other than 2(a), 2(b), 4(a), and 7(b), these figures may be doubled if the building is provided throughout with an appropriate automatic sprinkler system (see [Para 8.4.4](#)).
- (3) In buildings of Purpose Groups 1(c), 2(a) 2(b), all floors other than the lowest floor should be constructed as compartment floors (see Para 3.4.4.2 – 3.4.4.4).
- (4) In the case of Purpose Groups 2(a) and 2(b), the maximum area of compartment is the limiting factor.
- (5) For Purpose Group 2(a), a minimum of 2 compartments per storey are required (see [Para 1.4.5](#)).
- (6) See [Appendix D](#) for guidance on assessment of hazard in industrial and storage buildings.
- (7) Where a Purpose Group 7(b) building is sprinklered, the compartment limits for an unsprinklered Purpose Group 7(a) building may be applied.

A. Above Ground

A.1 Tall Buildings

In a building, with a topmost floor level of < 30m, compartmentation is based on Purpose Group requirements and / or floor area / volume requirements.

In a building with a topmost floor level of >30m, all floors should be compartment floors

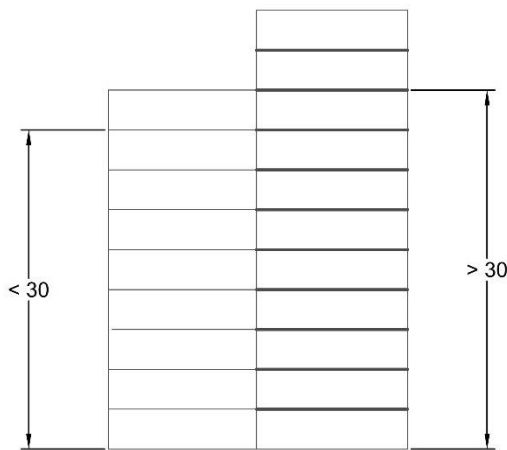

A.2 Compartment floor area / volume limits

Example of compartmentation in an unsprinklered shop.

Where a floor exceeds 2000m² it should be divided by compartment walls.

Where a volume exceeds 7100m³ compartment floors should be provided

Section A - A'

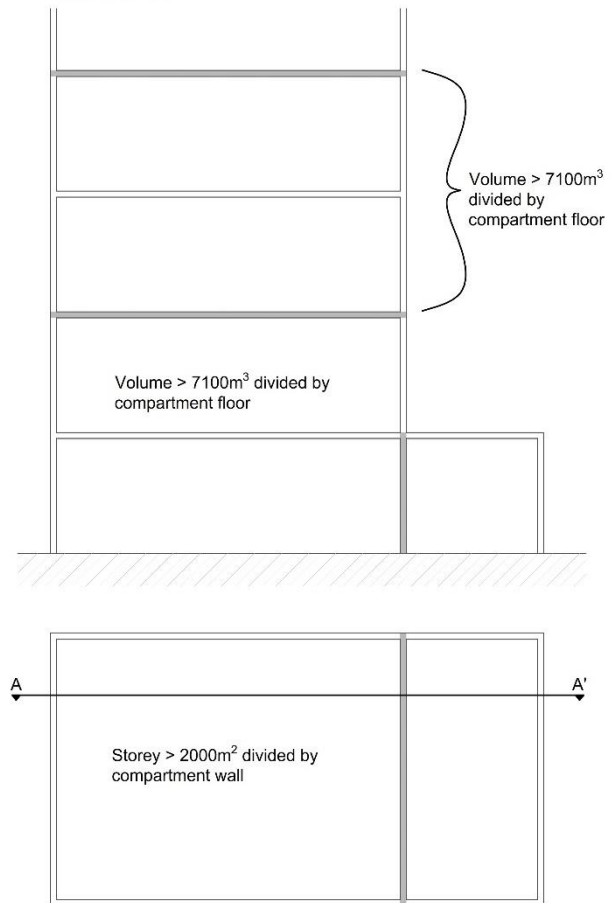

B. Below Ground

Only the floor of the ground storey should be a compartment floor if the depth of the basement is <10m

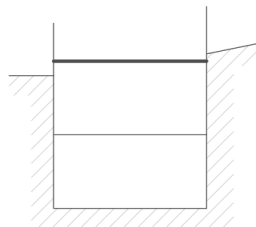

All basement floors should be compartment floors if the depth of the basement is >10m

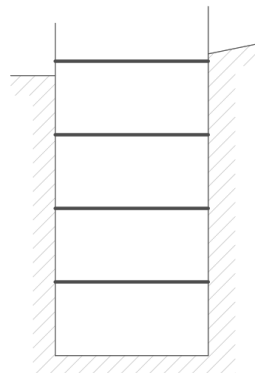

Section 3: Internal Fire Spread (Structure)

3.4.4.6 Shopping Centres (Purpose Group 4(b))

Shopping centres require special provisions in relation to compartmentation, due to the nature of the occupancies and the arrangement of individual units that make up these buildings, and because enclosed pedestrian mall areas are generally provided between individual units. While the majority of units comprise of individual shops of varying sizes, other uses such as assembly and recreation or offices may also be provided in these buildings.

In addition, certain types of ancillary accommodation, such as service areas, storage areas, and refuse storage areas, present particular high fire risk and require compartmentation.

In shopping centres, the following provisions apply:

- (a) The mall width between fascia of the units (see [Subsection 1.7](#)) should be:
 - (i) no less than 6 m in covered malls, or
 - (ii) no less than 5 m in uncovered malls; and
- (b) Compartment walls and/or floors should be provided between parts of the shopping centre which have different main uses; and
- (c) Compartment walls and/or floors should be provided:
 - (i) to meet the compartment sizes for individual units, based on their specific use (Purpose Groups) (see [Table 15](#));
 - (ii) between units; or
 - (iii) between units and service corridors; or
 - (iv) as floors covering (or partially covering) roads, or
 - (v) as walls separating covered fire service access roads and covered servicing areas from the remainder of the shopping centre; and
- (d) Compartmentation should also be provided between the mall and:
 - (i) any units with a floor area exceeding 3700 m² at any level; or
 - (ii) opposing units, where each has a floor area exceeding 2000 m² at a level; or
 - (iii) any upper storey of a unit which has open connections with a lower storey in that unit which also has access from the mall.

The compartmentation referred to in (d) above may be provided by fire shutters, or similar.

Smaller shop units would normally not be compartmented from a mall.

Section 3: Internal Fire Spread (Structure)

3.4.4.7 Provision of Fire-Resisting Walls

In addition to the requirements for compartment walls, there are a number of circumstances where areas in buildings have a higher level of fire risk, but are not deemed to be places of special fire risk. Such areas require separation from other parts of the building by fire-resisting walls. Such walls are not considered to be compartment walls.

The following rooms or areas should be enclosed by fire-resisting construction (see [Appendix A](#)), and any associated doors to the rooms should be fire doors (see [Appendix B](#)):

- (a) a kitchen, laboratory, workshop, cloakroom, any space with a fixed heat producing appliance, or any store-room in a non-residential school (Purpose Group 5(a)(ii)); or
- (b) a store room, laundry or kitchen in a pre-school, a crèche, a day nursery, or similar facilities (Purpose Group 5(b)(i)); or
- (c) a storage area (ancillary to the main use of the building – see [Subsection 0.5](#)), laboratory, kitchen, or engineering services installation room in an office or shop (Purpose Group 3 and 4(a)); or
- (d) a dressing room, kitchen, workshop, scene dock, or store room in a place of assembly with stages (Purpose Group 5(a)) (see [Para 1.4.8](#)).
- (e) Ancillary accommodation such as communal lounges, common amenity areas (areas such as communal kitchens, laundries, drying areas and occupiers' stores that are remote from individual dwellings) should be enclosed in fire-resisting construction (see Item 17 (b) [Appendix A](#), [Table 31](#)).

3.4.4.7.1 Ancillary accommodation in a Residential (Care facility) (Purpose Group 2(a)(ii))

Ancillary accommodation in a residential (care facility) building (Purpose Group 2(a)(ii)) should be enclosed by fire-resisting construction (see [Appendix A](#), [Table 31](#), Item 17a). Such ancillary accommodation may include the following

- (a) smoking rooms; or
- (b) linen stores; or
- (c) staff changing and locker rooms; or
- (d) all store rooms; or
- (e) rooms for the purpose of charging scooters or mobility apparatus; or
- (f) administrative areas (nurses' stations).

Where a sprinkler system (see [Para 8.4.2](#)) is provided throughout the building, walls between ancillary accommodation room do not need to be fire resisting.

Where a sprinkler system is provided, administrative areas (type (f) above) may be open to a protected corridor.

Section 3: Internal Fire Spread (Structure)

3.5 Construction of Compartment Floors and Compartment Walls

3.5.1 Performance Requirements for Compartment Walls and Compartment Floors

The performance requirements for fire-resisting elements of construction are indicated in [Appendix A, Subsection A4](#).

Every compartment wall and compartment floor should:

- (a) form a complete barrier to fire between the compartments they separate; and
- (b) have the appropriate fire resistance as indicated in [Appendix A, Table 31](#) and [Table 32](#); and
- (c) be constructed in accordance with the relevant guidance in Para's 3.5.2 to 3.5.17.

3.5.2 Compartment Floors in Residential (Care Facility) Buildings

In a residential (care facility) building (Purpose Group 2(a)), all compartment floors should be constructed of materials having a reaction-to-fire classification of Class A2 – s3, d2, or better (see [Appendix A](#)).

3.5.3 Compartment Floors in Shopping Centres

In a shopping centre building (Purpose Group 4(b)), any floor that covers (or partially covers) a fire-service-access roadway or a public roadway should be constructed of materials having a reaction-to-fire classification of Class A1 (see [Appendix A](#)).

3.5.4 Compartment Floors in Buildings > 11 m

In a building of any purpose group, where the height of the top storey is 11 m or more (see [Appendix C, Diagram 91](#)), any compartment floor which is required to have a fire resistance of 60 minutes or more should be constructed of materials having a reaction-to-fire classification of Class A2 – s3, d2, or better (see [Appendix A](#)), apart from any floor finish.

Section 3: Internal Fire Spread (Structure)

3.5.5 Compartment Walls

Compartment walls in the following buildings should be constructed of materials with a reaction-to-fire classification achieving A2 - s3, d2, or better (see [Appendix A](#)), (apart from any wall surface complying with the requirements for internal fire spread (linings)):

- (a) In a residential (care facility) building (Purpose Group 2(a)); or
- (b) In a building of any other purpose group, where
 - (i) the height of the topmost floor level is greater than 11m (see [Appendix C, Diagram 91](#)); and
 - (ii) there is a requirement to have a fire resistance of 60 minutes or more (see [Appendix A, Table 31](#)).

In a shopping centre building (Purpose Group 4(b)), compartment walls separating a covered roadway from the remainder of the shopping centre should be constructed of materials with a reaction-to-fire classification achieving A1 (see [Appendix A](#)).

3.5.6 Separating Walls

Compartment walls that are common to two or more buildings (separating walls) should be continuous, should run the full height of the building in a continuous vertical plane and should be constructed of materials having a reaction-to-fire classification Class A2 - s3,d2, or better (see [Appendix A](#)).

Adjoining buildings should only be separated by walls, not floors.

A compartment wall being used to divide a building into separate occupancies or uses is not a separating wall and would not be subject to this provision.

3.5.7 Accommodation of Services in Compartment Walls/Floors

The construction of compartment walls and floors, and of separating walls, may be such that the achievement of the required fire resistance performance (see [Para 3.5.1](#) and [Appendix A](#)) relies primarily on the integrity of the linings of such constructions. Typical examples of such constructions include framed structures with walls which incorporate plasterboard or similar fire-resistant linings and floor constructions with an enclosed void, with fire resistance provided by floor deck material and ceiling board.

The integrity of the linings of such constructions should not be breached to allow for the installation of services, e.g. pipes, wires, flues (including manufactured flues), except where necessary to allow services pass through these compartment walls or floors. A service void may be created on or under the unbreached linings of the fire-resistant compartment wall or floor to allow for services.

Section 3: Internal Fire Spread (Structure)

Where services pass through these compartment walls or floors, they should be contained in fire-resistant ducts, and the opening of such ducts should be protected and fire-stopped in accordance with [Subsection 3.7](#) of this document.

3.5.8 Separated Parts

Compartment walls used to form a separated part of a building (see [Diagram 89](#)) should run the full height of the building in a continuous vertical plane.

3.5.9 Compartment Junctions

Where a compartment wall or compartment floor meets another compartment wall or compartment floor, or an external wall, the junction should maintain the fire resistance of the compartmentation.

Where a compartment wall or floor meets an external wall, the compartmentation should be maintained to the inside surface of the outermost element, including external rendering and cladding systems, whether there is a void or not. Cavity barriers or fire breaks used for this purpose should extend across the full width of the compartmentation.

In ventilated cladding systems, it is necessary to maintain airflow in the cavity in non-fire conditions. Cavity barriers need not close the full width of the cavity if they are open state cavity barriers and have been appropriately tested.

Where an external system built wall requires a fire resistance due to a provision of Section 1, Section 3, or Section 4 it should be fixed to the structure in a manner that ensures the external wall will remain in place, for the required duration of fire resistance of the wall.

3.5.9.1 Junction of Compartment Walls with Floors

Compartment walls should be carried to meet the underside of the compartment floor above, or in the case of the topmost floor, be extended through the void to meet the underside of the roof (see [Para 3.5.13](#)).

Cavity barriers should not be used in place of compartment walls in roof voids, as they have a lesser fire resistance.

Section 3: Internal Fire Spread (Structure)

3.5.10 Junction of a Compartment Floor with an External Wall

For a building with a topmost floor > 15 m where a compartment floor meets an external wall, the compartmentation should be maintained by providing one of the following (see [Diagram 48](#)):

- (a) In all buildings, except residential (care facility) buildings (Purpose Group 2(a)), an appropriate sprinkler system, in accordance with [Section 8](#); or
- (b) At the wall/floor junction a 0.9 m fire-resisting zone having the same fire resistance as the floor (from each side); or
- (c) At compartment floor level an imperforate horizontal projection (which may incorporate a balcony) of not less than 0.5 m having the same fire resistance as the compartment floor (from the underside); or
- (d) At compartment floor level a recess of not less than 0.5 m having the same fire resistance as the compartment floor (from the underside).

Where a 0.9 m fire-resisting zone (see (a) above) meets a fire-resisting horizontal projection of > 0.5 m (b above), the fire-resisting zone shall overlap the projection for a distance of 0.45 m (see [Diagram 48](#)).

This provision does not apply to a building with an atrium, where the accommodation is open to the atrium (see [Para 3.8.3](#)).



Accommodation which projects outwards from the face of the building, above a compartment floor, does not meet the requirements of (c) above.

The junction of a basement compartment floor with an external wall should also meet these provisions.

The provisions of [Para 3.5.5](#) are not applicable to a non-loadbearing external wall forming the fire resisting zone at (a) above, however, any external wall should meet the provisions of [Section 4](#).

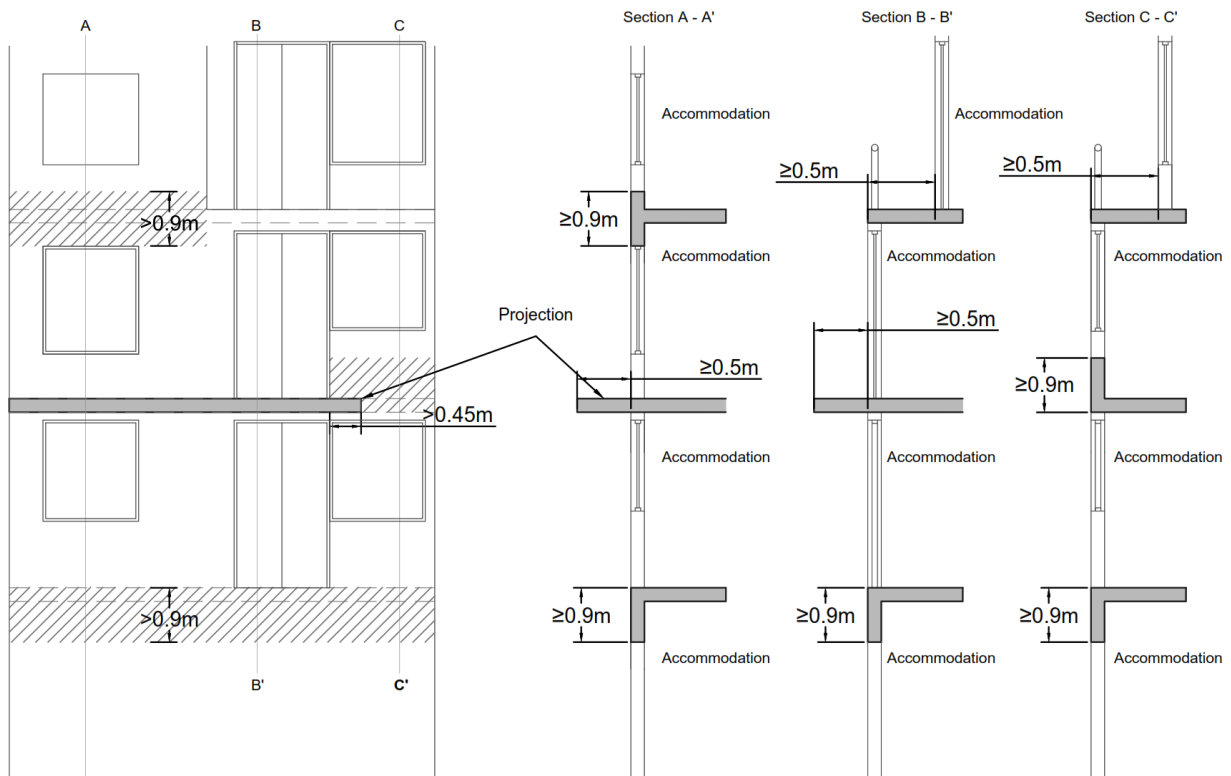
Diagram 48 Junction of a Compartment Floor With an External Wall Para 3.5.10



-  Area of elevation requiring fire resistance from both sides
-  Fire resisting construction equal to that of the compartment floor

Notes:

- (1) Where the fire-resisting zone is achieved, the projection does not need to be fire resisting.
- (2) In addition to these requirements, there may be additional requirements in relation to external fire spread (see [Subsection 4.4](#)).

Section 3: Internal Fire Spread (Structure)

3.5.11 Junction of a Compartment Wall with an External Wall

Where a compartment wall, separating wall or protected shaft wall meets an external wall, the junction should maintain the fire resistance of the compartmentation.

3.5.11.1 Buildings other than Residential (Care Facility) buildings

For all buildings, excluding residential (care facility) buildings (Purpose Group 2(a)), the external wall should have a fire resistance (from the inside) equal to that of the compartment wall for a distance (see [Diagram 49](#)) of:

- (a) 0.5 m, where the internal angle is between 90° and 135°; or
- (b) 1.0 m, where the internal angle is < 90°.

For angles > 135°, there is no requirement for the external wall to be fire resisting.

3.5.11.1.1 Exclusions

This provision does not apply to:

- (a) any building with an open atrium, i.e. where the accommodation is not separated from the atrium; or
- (b) buildings where a sprinkler system (see [Section 8](#)) has been installed throughout the building or compartment on each side of the compartment wall serving the accommodation.

3.5.11.2 Residential (care facility) buildings

For residential (care facility) (Purpose Group 2 (a)) buildings, the external wall should have a fire resistance (from the inside) equal to that of the compartment wall for a distance (see [Diagram 49](#)) of 1.0 m.

Where a compartment wall is enclosing a protected shaft containing a stairway, or a firefighting shaft, additional provisions (see [Section 1](#) and [Section 5](#)) may apply.

Diagram 49 Junction of a Compartment Wall With an External Wall

Para 3.5.11

(a) All buildings except residential (care facility) buildings (Purpose Group 2(a))

Angle $>90^\circ, <135^\circ$

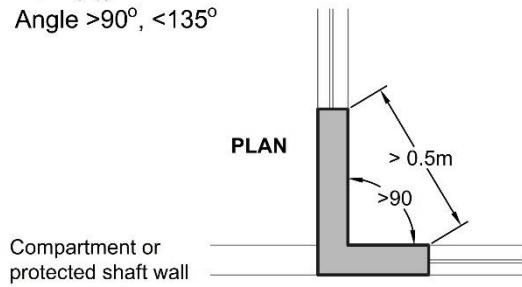

(b) Angle $<90^\circ$

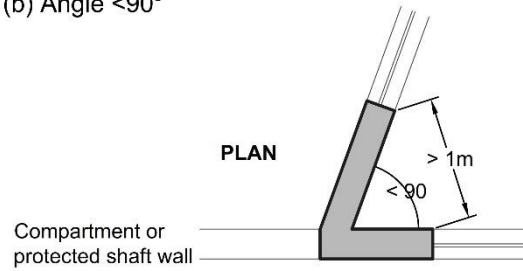

(b) Residential (care facility) buildings (Purpose Group 2(a))

Angle $<135^\circ$

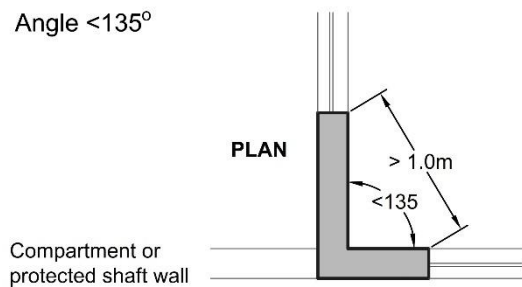

(b) Angle $>135^\circ$

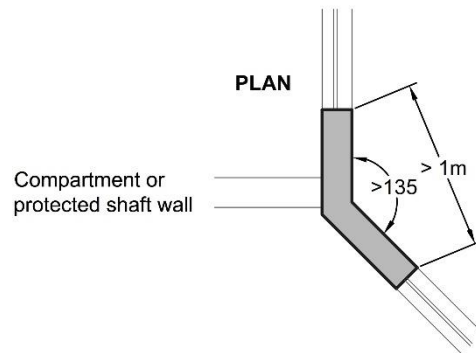

3.5.12 Opposite Elevations of the Same Building

To limit fire spread between different compartments, where opposing elevations of the same building form separate compartments, it is necessary to consider the space separation between opposing elevations.

External fire-spread calculations based on a notional boundary between opposing elevations should be carried out in accordance with [Section 4](#).

Section 3: Internal Fire Spread (Structure)

3.5.13 Junction of Compartment Wall and Roof

The junction between a compartment wall and the roof of a building should be capable of restricting fire spread between compartments. A compartment wall should be taken up to meet the underside of the roof covering or deck (including through any void space) and fire stopped where necessary at the wall/roof junction (see [Diagram 50](#)).

A compartment wall should not be stopped at ceiling level, but should extend through the void to meet the underside of the roof. Cavity barriers should not be used in place of compartment walls in roof voids, as they have a lesser fire resistance.

The construction of the wall, particularly between any ceiling and the roof, should not contain imperfections that would provide a route for fire penetration or premature failure of the fire-resistance performance of the wall.

The gap between the wall and the underside of the roof covering should be as small as practicable (generally not greater than 50mm) and be filled with suitable fire-stopping material over the full width of the wall.

Structural roof members should not be carried across a separating wall.

Where structural or non-structural roof elements are built into or carried across a compartment wall, any openings for them should be as small as practicable, and any gaps should be suitably protected on either side of the compartment wall and effectively fire stopped with an appropriate fire stopping material over the full width of the wall in order that failure of the member will not compromise the compartmentation.

Where a trussed rafter supporting a roof is carried across a compartment wall, the truss should be designed so that failure due to fire in one compartment will not cause failure of any part of the truss in another compartment.

The design and detailing of the junction between a compartment wall and any roof valley, gutter or other roof configuration should be carefully considered so as to ensure that a means of premature fire spread between compartments is not provided at the junction.

Section 3: Internal Fire Spread (Structure)

Diagram 50 Junction of Compartment Wall With Roof

Para 3.5.13

(a) All Purpose Groups

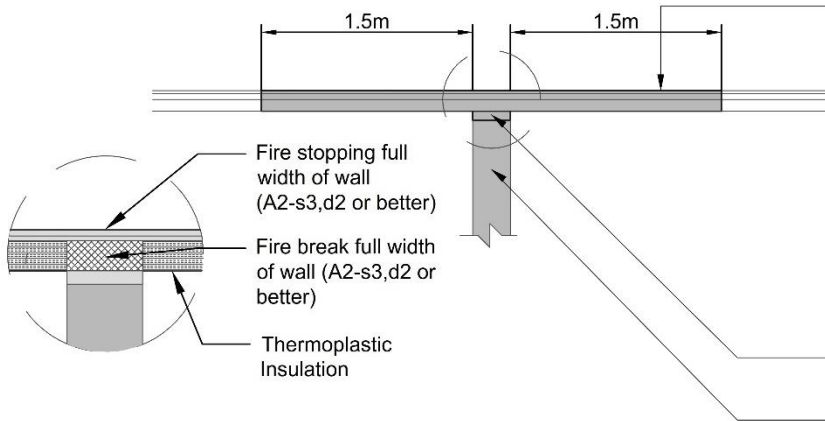

Roof covering to be of class $B_{ROOF}(t4)$ on a substrate or deck of material rated class A2-s3,d2 or better over at least this distance. Roof covering and deck could be composite structure, e.g. profiled steel cladding.

Double-skinned insulated roof sheeting should incorporate a band of material rated Class A2-s3,d2, or better at least 300mm wide centred over the wall.

Resilient firestopping between compartment wall and underside of roof deck.

Compartment wall carried up to underside of roof deck.

(b) Flats, residential (other), offices, or assembly (Purpose Group 1(c), 2(b), 3, or 5) building not more than 16.5m high

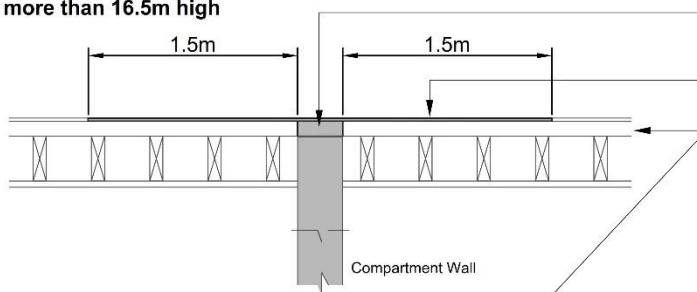

Firestopping to be carried up to underside of roof covering.

Roof covering to be of class $B_{ROOF}(t4)$ on deck of material, rated class A2-s3,d2 or better, over at least this distance.

Timber tiling battens or combustible boarding may be carried over the compartment wall, provided that they are fully bedded in mortar or other suitable fire stopping material for the full width of the wall.

Typical eaves / roof detail

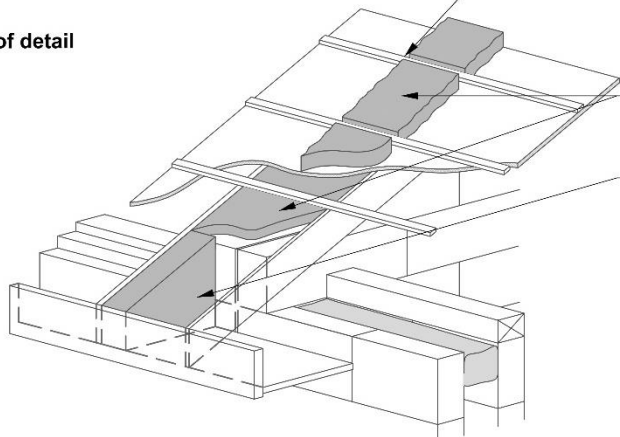

Mineral fibre quilt (or equivalent) above and below felt.

Fire-stopping material (e.g. 50mm wire reinforced mineral fibre quilt or equivalent) to fully fill eaves, in line with compartment / separating wall.

The compartment wall does not necessarily need to be of masonry construction.

(c) Parapet wall - any Purpose Group, any height

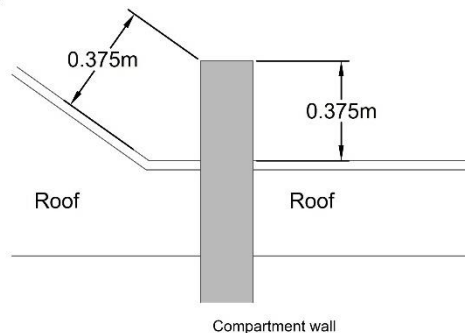

The wall should be extended up through the roof for a height of at least 0.375m (when measured perpendicular to the roof) above the top surface of the adjoining roof covering.

Section 3: Internal Fire Spread (Structure)

3.5.14 Roof Characteristics at Compartment Wall Junction

If a fire penetrates a roof near a compartment wall, there is a risk that it will spread over the roof to the adjoining compartment.

3.5.14.1 All purpose groups

To reduce that risk, the junction between a compartment wall and a roof should have a covering of class B_{ROOF}(t4) (see [Appendix A, Table 35](#)) on a substrate or deck of material rated class A2-s3, d2 or better for a 1.5 m wide zone of the roof on either side of the wall.

The compartment wall should be carried up to the underside of the roof deck and be fire stopped with suitable firestopping materials over the full width of the wall (see [Diagram 50 \(a\)](#)).

Where the roof deck or external wall comprises a double-skin insulated sheet, the insulating material directly above or adjacent to the compartment wall should be constructed of materials with a reaction-to-fire classification achieving A2-s3, d2, or better ([Appendix A, A7](#)) for a width of not less than 0.3 m which forms a fire-stopping seal to the cavity between the inner and outer skins. In the case of a non-insulated double-skin roof deck, similar fire stopping should also be provided.

3.5.14.2 Flats, Residential (Other), Office, or Assembly Buildings < 16.5m

In buildings not more than 16.5 m high (see [Appendix C, Diagram 90](#)) which are used as residential (except care facility), offices, or assembly (Purpose Group 1(c), 2(b), 3, or 5), timber tiling battens or boarding materials with a reaction-to-fire classification lower than Class A2-s3, d2 or worse may be carried over the compartment wall, provided that they are fully bedded in mortar or other suitable fire-stopping materials (see [Subsection 3.7](#)). The roof should achieve a B_{ROOF}(t4) requirement for a distance of 1.5m on both sides of the compartment wall.

Any cavities within the thickness of the roof, above and below the sarking felt or similar membrane along the line of the wall and at the eaves should be adequately fire-stopped (see [Diagram 50 \(b\)](#)).

3.5.14.3 Parapet Wall

For a building of any use (Purpose Group) protection of fire spread between compartments at the roof junction may be provided by extending the compartment wall above the line of the external roof surface by a height of not less than 0.375 m to form a parapet wall (see [Diagram 50 \(c\)](#)). The distance to the top of the parapet wall should be measured perpendicular to the plane of the roof.

Section 3: Internal Fire Spread (Structure)

3.5.14.4 Other proven systems

Any other system which has been shown by test to be equally effective in restricting the spread of fire at a compartment wall/roof junction may be used, provided that the system conforms to Part D of the Building Regulations.

3.5.15 Openings between Compartments

3.5.15.1 Openings in Compartment Walls

Any door openings in compartment walls should be protected by means of fire doors, in accordance with the provisions outlined in [Appendix B](#) and [Table 36](#).

Openings for the passage of pipes, ducts and other services should be protected in accordance with the provisions outlined in [Subsection 3.7](#).

3.5.15.2 Openings in Separating Walls

There should be no openings in a wall which is common to two or more buildings (a separating wall).

3.5.15.3 Openings in Compartment Floors

Openings in compartment floors should be limited to those for:

- (a) protected shafts which meet the relevant provisions below; or
- (b) the passage of pipes, ventilation ducts, chimneys, appliance ventilation ducts or ducts encasing one or more flue pipes, which meet the provisions in [Subsection 3.7](#); or
- (c) refuse chutes constructed of materials with a reaction-to-fire classification achieving A1; or
- (d) atria designed in accordance with the provisions of [Para 3.8.3](#).

3.5.16 Protected Shafts

Any stairway or other shaft connecting compartments should be enclosed so as to delay or prevent the spread of fire between compartments, and is termed “a protected shaft”.

If the protected shaft is a stairway, the provisions in Section 1 relating to protected stairways also apply.

If the protected shaft is in a building with a topmost level of 20 m, and is designed to provide access for firefighters, the provisions of Section 5 relating to firefighting shafts also apply.

Section 3: Internal Fire Spread (Structure)

Where a compartment wall also serves as the wall enclosing a protected stairway, the provisions in Section 1 in relation to the junction of an external wall and the enclosure to a protected stairway (see [Para 1.5.6.6](#)) should be met.

3.5.16.1 Construction of Protected Shafts

The construction enclosing a protected shaft (see [Diagram 51](#)) should:

- (a) form a complete barrier to fire between the different compartments which the shaft connects; and
- (b) have the appropriate fire resistance given in [Appendix A, Table 31](#), except for glazed screens which meet the provisions of [Para 3.5.16.3.1](#); and
- (c) meet the requirements of [Para 3.5.5](#) for the construction of compartment walls; and
- (d) satisfy the provisions about their use and ventilation, and the treatment of openings, in the paragraphs below.

3.5.16.2 Use for Protected Shafts

Protected shafts should only be used for:

- (a) stairways; or
- (b) lifts; or
- (c) escalators; or
- (d) chutes; or
- (e) ducts; or
- (f) pipes.

Protected shafts may also include sanitary accommodation and washrooms that are not changing facilities.

Section 3: Internal Fire Spread (Structure)

3.5.16.3 Protected Shafts Containing a Stairway

3.5.16.3.1 Glazed Screens

Where a protected shaft contains a stairway, but is not a firefighting shaft (see [Subsection 5.5](#)), and is entered from a protected corridor or lobby, the part of the enclosure between the shaft and the corridor or lobby may incorporate a glazed screen. The glazed screen (see [Diagram 52](#)) should conform to the following:

- (a) The protected shaft should have a fire resistance as specified in [Appendix A](#); and
- (b) The protected shaft should be accessed via a protected lobby or corridor with a fire resistance as specified in [Appendix A](#); and
- (c) The glazed screen should be located between the protected lobby / corridor and the protected shaft only; and
- (d) The glazed screen should achieve a minimum fire resistance as specified in [Appendix A, Table 31](#); and
- (e) The provisions of [Table 34](#) and [Table 37](#) of [Appendix A](#) should be met.

3.5.16.3.2 Pipes for Oil or Gas

Where a protected shaft contains a stairway and/or lift, the shaft should not contain:

- (a) a pipe conveying oil or gas (other than hydraulic oil in the mechanism of a hydraulic lift); or
- (b) a ventilating duct other than:
 - (i) a duct provided for the purposes of pressurising the stairway to keep it smoke free; or
 - (ii) a duct provided for the ventilation of the stairway (see [Section 6](#)); or
 - (iii) a duct provided for the sole purpose of the operation of the lift.

3.5.16.3.3 External Openings

An external wall of a protected shaft does not normally need to have fire resistance unless:

- (a) it is a fire-fighting shaft, (see [Subsection 5.5](#));
- (b) it is required to under the provisions of [Para 3.5.11](#)); or
- (c) it contains a stairway, and the layout is such that it may expose persons to risk (see [Para 1.5.6.6](#)).

Section 3: Internal Fire Spread (Structure)

3.5.16.4 Internal Openings into all Protected Shafts

Internal openings in parts of the enclosure to a protected shaft (other than an external wall opening) should be limited to the following:

- (a) Doors which have the appropriate fire resistance given in [Appendix B, Table 36](#), and are fitted in accordance with the provisions of [Appendix B](#); or
- (b) The passage of pipes which meet the provisions in [Subsection 3.7](#); or
- (c) The passage of other services including power, communications, etc. which meet the provisions of [Subsection 3.7](#); or
- (d) Inlets to, outlets from and openings for a ventilation duct, (if the shaft contains or serves as a ventilating duct) which meet the provisions in [Subsection 3.7](#).
- (e) The passage of lift cables into a lift motor room. (If the motor room is at the bottom of the shaft, the openings should be as small as practicable.)

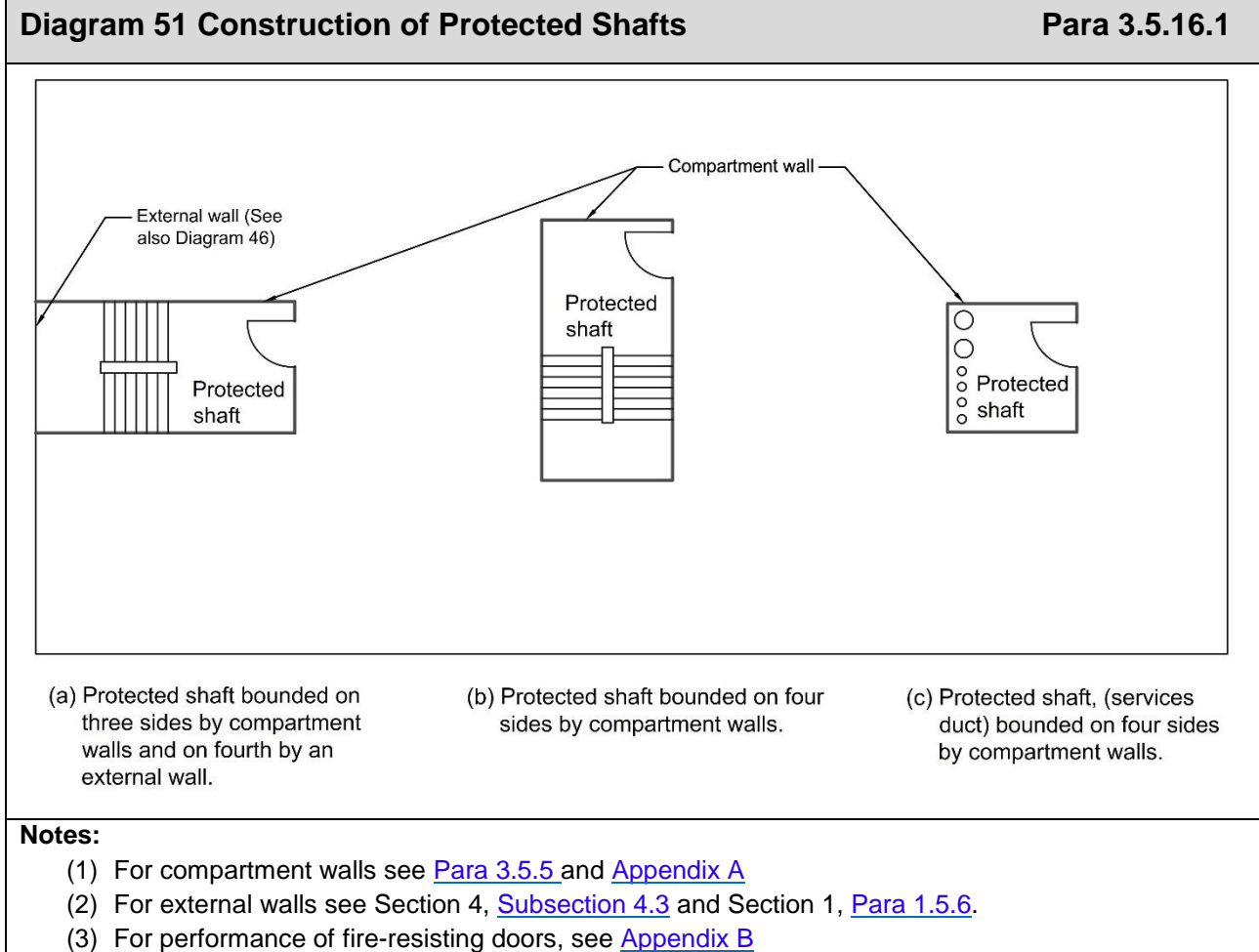

Section 3: Internal Fire Spread (Structure)

3.5.16.5 Ventilation of Protected Shafts Conveying Gas

A protected shaft conveying piped flammable gas should be adequately ventilated top and bottom, direct to the outside of the building.

Where the base of the shaft terminates inside the building, ventilation may be provided by a dedicated supply which is adequately fire protected.

Further guidance on such shafts, including guidance on sizing of ventilation openings, is contained in *I.S. 813 Domestic Gas Installations* and *I.S. 820 Non Domestic Gas Installations*.

Diagram 52 Glazed Screen Separating Protected Shaft From Lobby Para 3.5.16.3.1 or Corridor

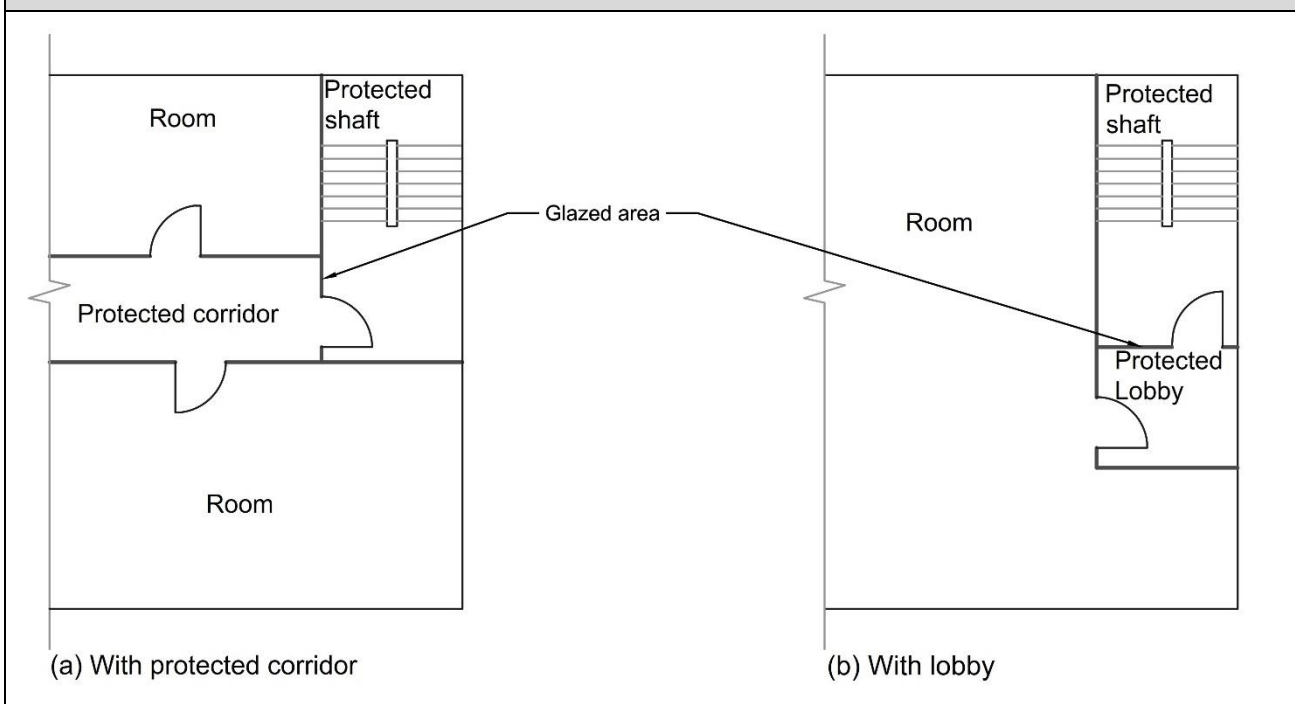

Notes:

- (1) For limitations on the use of uninsulated fire-resisting glazed elements in walls on escape routes, see [Appendix A, Table 34](#).
- (2) For limitations on the use of uninsulated fire-resisting glazed elements in doors on escape routes, see to [Appendix B, Table 37](#).
- (3) For provision of fire resisting construction, see [Appendix A](#).
- (4) For provision of compartmentation, see [Subsection 3.4](#) and [Appendix A](#).
- (5) For provision of fire doors, see [Appendix B](#).

Section 3: Internal Fire Spread (Structure)

3.6 Concealed Spaces (Cavities)

3.6.1 Introduction

Concealed spaces in the construction of a building provide a ready route for smoke and flame spread. This is particularly so in the case of voids above other spaces in a building, e.g. above a suspended ceiling or in a roof space. This presents a greater danger as the spread is concealed. Provisions are made to restrict this by using cavity barriers to interrupt concealed spaces (cavities) which could form a pathway around a barrier to fire. Cavity barriers should not be confused with fire stopping (see [Subsection 3.7](#)); the latter is used to close imperfections of fit.

3.6.2 Provision of Cavity Barriers

Cavity barriers should be provided in accordance with [Table 16](#) in specified locations for the different purpose groups.

The maximum dimensions of concealed spaces should be in accordance with the provisions outlined in [Para 3.6.3](#).

Table 16 Provision of Cavity Barriers				
		Purpose Group to which the provision applies		
Cavity barriers should be provided:		1(c)	2(a), 2(b)	3-8
1	At the top of an external cavity wall and at the junction of any such wall with a separating wall.	✓	✓	✓
2	At the junction between an external cavity wall, and every compartment floor and compartment wall.	✓	✓	✓
3	At the junction between an internal cavity wall and every compartment floor, compartment wall, or other wall or door assembly which forms a fire-resisting barrier.	✓	✓	✓
4	At the junction between any internal cavity compartment wall or cavity compartment floor and any other internal cavity compartment wall or cavity compartment floor.	✓	✓	✓
5	In a protected escape route, above or below any fire-resisting construction which is not carried full storey height, or (in the case of a top storey) to the underside of the roof covering. ⁽¹⁾	✓	✓	✓
6	Above or below any bedroom partitions which are not carried full storey height, or (in the case of a top storey) to the underside of the roof covering. ⁽¹⁾	X	✓	X
7	Where a corridor (which is not a protected corridor) should be subdivided to prevent fire or smoke from affecting the routes to two exits simultaneously (see Section 1, Subsection 1.4 and Diagram 9), above any corridor enclosures which are not carried full storey height, or (in the case of a top storey) to the underside of the roof covering. ⁽¹⁾⁽²⁾	X	✓	✓
8	Any cavity void, including any roof space that needs to be subdivided so that the distance between cavity barriers does not exceed the dimensions given in Table 17 .	X	✓	✓
✓ Denotes that provision of cavity barriers apply. X Denotes that provision of cavity barriers do not apply.				
(1) The provisions in items 5 and 6 of this table do not apply where the cavity above is enclosed on the lower side by a fire-resisting ceiling (as shown in Diagram 9) which extends throughout the building, compartment or separated part, which conforms to Para 3.6.3.1 .				
(2) The provision in item 6 of this table does not apply where the storey is subdivided by fire-resisting construction carried full storey height and passing through the line of sub-division of the corridor (see Diagram 9 (b)), or where the cavity above is enclosed on the lower side as described in Note (1).				

Section 3: Internal Fire Spread (Structure)

Diagram 53 Interrupting Concealed Spaces (Cavity Barriers)

Para 3.6.2

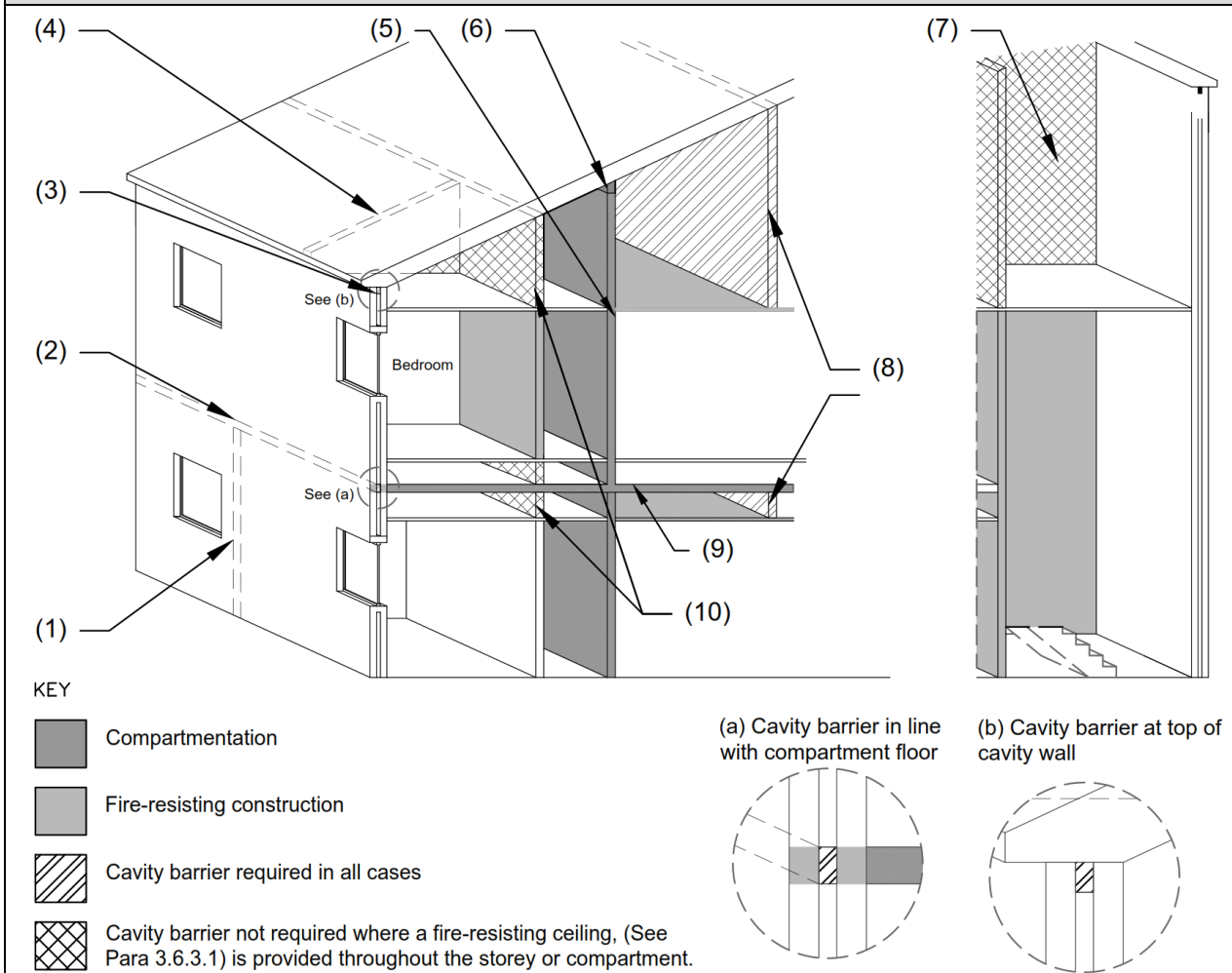

Notes:

- (1) Cavity barrier in line with compartment wall ([Table 16 \(2\)](#))
- (2) Cavity barrier in line with compartment floor ([Table 16 \(2\)](#))
- (3) Cavity barrier at top of cavity wall ([Table 16 \(1\)](#))
- (4) Cavity barrier above bedroom partitions ([Table 16 \(6\)](#))
- (5) Compartment wall
- (6) Compartment wall extended to underside of the roof and fire stopped
- (7) Cavity barrier in void above protected stairway (but not a protected shaft) ([Table 16 \(5\)](#))
- (8) Cavity barrier to divide extensive voids ([Table 16 \(8\)](#), [Para 3.6.3.1](#))
- (9) Compartment floor
- (10) Cavity barrier in void above protected corridor ([Table 16 \(5\)](#))

Table 17 Maximum Dimensions of Cavities

Location of cavity	Class of surface exposed in cavity (excluding surface of any pipe cable or conduit, or insulation to any pipe)	Maximum dimension in any direction (m)
Between a roof and a ceiling, or in a raised access floor	Any class	20
Any other cavity	Class C – s3, d2 (European) or better	20
	Any lower class	10

Section 3: Internal Fire Spread (Structure)

3.6.3 Maximum Dimensions of Concealed Spaces

The dimensions of cavities (i.e. the maximum undivided concealed space) should not exceed those specified in [Table 17](#). However, the provisions of [Table 17](#) do not apply to any cavity described at (a) to (g) below:

- (a) where any room with a ceiling cavity or raised access floor cavity exceeds the dimensions given, in which case cavity barriers need only be provided on the line of the enclosing walls/partitions of that room - subject to cavity barriers not being more than 40 m apart in any direction and the surface of the material/product exposed in the cavity being Class C-s3, d2 or better; or
- (b) where the cavity is over an undivided area and is used as a plenum and exceeds 40m (in both directions on plan), in which case there is no limit to the size of the cavity if
 - (i) the room and the cavity together are compartmented from the rest of the building; and
 - (ii) an automatic fire detection and alarm system is fitted in the building with smoke detectors in the cavity and in the return air ducting, and which stops circulation of the ventilation system and switches it to extract; and
 - (iii) the surface of the material or product used in the construction of the ceiling which is exposed in the cavity is Class B-s3, d2 or better and the supports and fixings of the suspended ceiling in the cavity are constructed of materials with a reaction to fire classification achieving Class A1; and
 - (iv) the reaction to fire classification of any pipe insulation system is Class C-s3, d2 or better; and
 - (v) any electrical wiring in the void is laid in metal trays or in metal conduits; and
 - (vi) any other materials in the cavity have a reaction to fire classification achieving A2 - s3, d2, or better.
- (c) in a wall which should be fire resisting only because it is load-bearing (see [Appendix A, Table 31](#), Item 2); or
- (d) in a floor or a roof space where the cavity is enclosed on the lower side by a fire-resisting ceiling (as shown in [Diagram 42](#) (b)) which extends throughout the building, compartment or separated part, subject to a limit of 30 m on the extent of any such cavity; or
- (e) below a floor next to the ground or oversite concrete, if the floor is imperforate and:
 - (i) the cavity is less than 1 m in height; and
 - (ii) the cavity is not normally accessible by persons; or
- (f) between double-skinned corrugated or profiled insulated roof and wall sheeting if the sheeting is a material with a reaction to fire classification achieving A2 - s3, d2, or better, and both surfaces of the insulating layer have a reaction to fire classification of at least Class C-s3, d2 or better (see [Appendix A](#)) and make contact with the inner and outer skins of cladding (see [Diagram 54](#)); or
- (g) Within the ceiling void over an operating theatre or endoscopy room in a Hospital (Purpose Group 2(a)(i)).

Section 3: Internal Fire Spread (Structure)

3.6.3.1 Cavity Barriers above Fire-Resisting Ceilings

The distance (referred to in [Table 17](#) above) between cavity barriers in concealed roof spaces can be increased to 30 m by the use of a fire-resisting ceiling below the cavity (see [Diagram 8](#), [Diagram 9](#), [Diagram 42\(b\)](#)). Such a ceiling should comply with all the following requirements. It should

- (a) have a fire resistance as specified in [Appendix A](#); and
- (b) be imperforate except for an opening allowed under [Para 3.6.5](#); and
- (c) extend throughout the building or compartment; and
- (d) not be demountable; and
- (e) have a reaction to fire classification of Class B - s3, d2 surface on the soffit, (and at least a Class C - s3, d2) surface facing the cavity (see [Diagram 42](#));

Thermoplastic lighting diffusers should not be used in a fire-resisting ceiling, unless they have been satisfactorily tested as part of the ceiling system that is to be used to provide the appropriate fire protection.

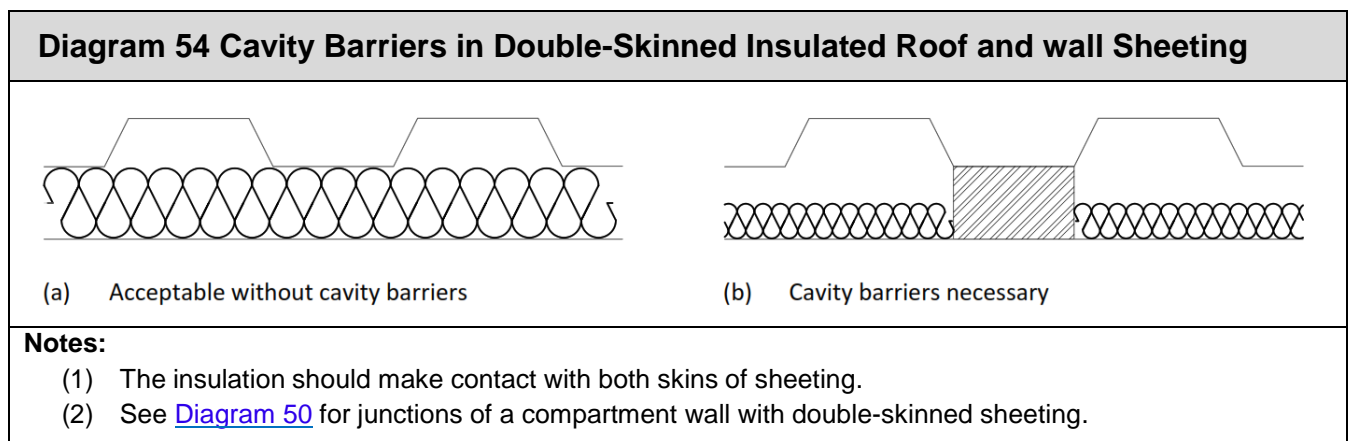

3.6.4 Performance of Cavity Barriers

3.6.4.1 Performance Requirements for Cavity Barriers

Every cavity barrier, when tested (from each side separately), should provide a minimum fire resistance (see [Appendix A](#), [Table 31](#), item 18) of the following:

- (a) 30 minutes' integrity (E 30), and
- (b) 15 minutes' insulation (I 15).

Cavity barriers may be formed by a construction provided for another purpose if it achieves the same performance.

Section 3: Internal Fire Spread (Structure)

3.6.4.2 Cavity Barriers in Stud Walls or Partitions

Any cavity barrier required in a stud wall or partition may be formed of:

- (a) steel at least 0.5 mm thick; or
- (b) timber at least 38 mm thick; or
- (c) polythene-sleeved mineral wool, or mineral-wool slab, in either case under compression when installed in the cavity; or
- (d) calcium silicate, or cement-based board being a minimum of 12 mm thick; or
- (e) gypsum-based board of 12 mm thick when used in an internal stud wall or partition; or
- (f) proprietary cavity barriers.

3.6.4.3 Construction and Fixing of Cavity Barriers

Cavity barriers should be tightly fitted to rigid construction and mechanically fixed in position wherever possible. Where this is not possible (for example, in the case of a junction with slates, tiles, corrugated sheeting or similar materials) the junction should be fire-stopped.

Cavity barriers should also be fixed so that their performance is unlikely to be made ineffective by:

- (a) movement of the building due to subsidence, shrinkage or thermal change and movement of the external envelope due to wind; or
- (b) collapse in a fire of any services penetrating them; or
- (c) failure in a fire of their fixings; or
- (d) failure in a fire of any material or construction which they abut.

3.6.5 Openings in Cavity Barriers

Any openings in a cavity barrier should be limited to those for any of the following:

- (a) Doors which have at least 30-minute fire resistance (see [Appendix B, Table 36](#), item 7) and are fitted in accordance with the provisions of [Appendix B](#); or
- (b) The passage of pipes which meet the provisions in [Subsection 3.7](#); or
- (c) The passage of cables or conduits containing one or more cables which meet the provisions in [Subsection 3.7](#); or
- (d) Openings fitted with a suitably mounted automatic fire shutter; or
- (e) Ducts which (unless they are fire resisting) are fitted with a suitably mounted automatic fire damper where they pass through the cavity barrier.

3.7 Protection of Openings

3.7.1 Introduction

Earlier sections of this document describe the provision of barriers to fire, and the circumstances in which there may be openings in them. This subsection deals with the protection of openings in such constructions.

If an element that is intended to provide fire separation (i.e. it has requirements for fire resistance in terms of integrity and insulation) is to be effective, then every joint, or imperfection of fit, or opening to allow services to pass through the element, should be adequately protected. This may be achieved by measures such as sealing or fire-stopping so that the fire resistance of the element is not impaired.

Provisions for door openings and fire doors are given in [Appendix B](#).

The measures are intended to delay the passage of fire. They generally have the additional benefit of retarding smoke-spread, but the test specified in [Appendix A](#) for integrity does not stipulate criteria for the passage of smoke as such.

Provisions for the adequate protection of pipes (excluding ventilation pipes and flue pipes) are specified under [Para 3.7.2](#).

Provisions for the adequate protection of pipes forming part of a ventilation system are specified under [Para 3.7.3](#). A natural ventilation pipe set in an external wall only, does not need to meet the provisions of [Para 3.7.3](#) where the external wall is constructed of solid or twin-leaf masonry, or of concrete.

Provisions for the adequate protection of flue pipes are specified under [Para 3.7.4](#).

3.7.2 Openings for Pipes

Pipes which pass through a compartment wall, compartment floor, protected corridor or cavity barrier should meet the appropriate provisions as specified in A, B or C below. An exception to this is where the pipe is in a protected shaft.

A: Proprietary Seals (Any Pipe Diameter)

A proprietary sealing system which has been shown by test to maintain the fire resistance of the wall, floor or cavity barrier should be provided.

B: Pipes with a Restricted Diameter

Where a proprietary sealing system is not used, fire-stopping may be used around the pipe, keeping the opening as small as possible. The nominal internal diameter of the pipe should not be more than the dimension given in [Table 18](#) for the relevant pipe material.

Section 3: Internal Fire Spread (Structure)

C: Pipe Sleeving

Where a pipe of lead, aluminium, aluminium alloy or PVC-u, with a maximum nominal internal diameter of 160mm, is used, pipe sleeving of materials with a reaction-to-fire classification achieving A1 as shown in [Diagram 55](#) should be provided. Specifications for pipes composed of materials with a reaction-to-fire classification achieving A1 and PVC-u pipes are given in the notes to [Table 18](#).

Table 18 Maximum Nominal Internal Diameter of Pipes			Para 3.7.2(B)
Purpose	(a)	(b)	(c)
	Material achieving RtF of A1 (mm) ⁽¹⁾	Lead, aluminium or aluminium alloy, fibre-cement or PVC-u (mm) ⁽²⁾	Any other material (mm)
Structure (not a separating wall) enclosing a protected shaft which is not a stairway or lift shaft	160	110	40
Any other situation	160	40	40

Notes:

(1) A material with a reaction-to-fire classification achieving A1 (such as cast iron or steel) which, if exposed to a temperature of 800°C will neither soften nor fracture to the extent that flame or hot gases will pass through the wall of the pipe.

(2) PVC-u pipes complying with BS 4514: 2001, BS 5255: 1989, or I.S. EN 1329-1.

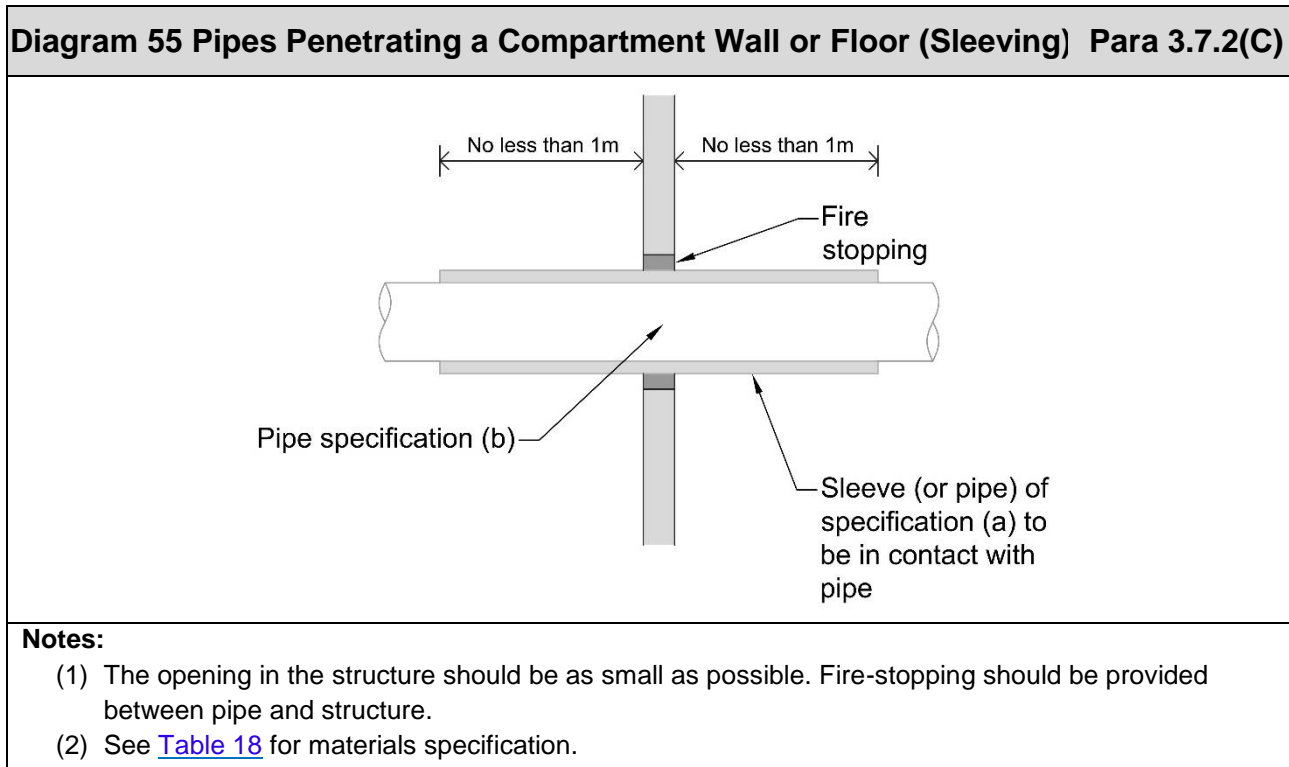

Section 3: Internal Fire Spread (Structure)

3.7.3 Ventilation Systems

Modern building design includes the installation of specific purpose ventilation, by natural or mechanical means. Certain uses of building, e.g. commercial kitchens, also require ventilation systems for the extraction of pollutants, excess water vapour, etc.

3.7.3.1 Ventilation Ductwork

Ventilation ductwork may provide a route for the spread of smoke within the building, through fire-resisting barriers. The dangers posed by the perforation of fire compartment enclosures are exacerbated in the case of mechanical ventilation and air conditioning systems by, firstly, the size of both the ductwork and the holes needed for it to go through and, secondly, the need for ventilation ductwork, by design, to ensure the efficient circulation of air throughout the system.

Guidance on the installation of mechanical ventilation and air conditioning plant is given in I.S. EN 15423.

3.7.3.2 General Provisions

Where the method of ventilation in a building is through a mechanical ventilation and air conditioning system, it should be designed and installed to inhibit the spread of smoke via the ductwork.

Any mechanical ventilation system should be designed to ensure that, in a fire, the air movement is directed away from protected escape routes and exits.

Under fire conditions, ventilation and air-conditioning systems should be compatible with smoke control systems and need to be considered in their respective design.

Where a pressurisation system is installed, any ventilation and air conditioning systems should be compatible with it.

Terminals of exhaust points should be sited away from:

- (a) final exits; or
- (b) cladding or roofing materials achieving Class B - s3, d2 or worse; or
- (c) any openings into the building.

Non-domestic kitchens, car parks and plant rooms should have separate and independent extraction systems. Extracted air should not be recirculated.

Section 3: Internal Fire Spread (Structure)

3.7.3.2.1 Recirculating air Systems

In a system that recirculates air, smoke detectors should be fitted in the extract ductwork before both of the following:

- (a) the point where recirculated air is separated from air to be discharged to the outside; and
- (b) any filters or other air cleaning equipment.

When smoke is detected by detectors, the fire detection and alarm system should be designed to do one of the following

- (i) cause the ventilation system to immediately shut down; or
- (ii) switch the ventilation system from recirculating mode to extraction in order to divert smoke outside the building.

The provisions of this section do not apply to an independent domestic recirculating air system installed within an individual flat.

3.7.3.3 Buildings Containing Flats

Generally, mechanical ventilation systems, including heat recovery and/or demand control systems in individual dwellings units (flats or maisonettes) are self-contained systems.

Ventilation systems serving more than one unit are not appropriate in buildings containing flats and should not penetrate compartment walls separating individual units.

In individual flats self-contained ventilation systems, where practicable, should be designed such that they do not penetrate a protected entrance hallway. However, where any ventilation system ducts penetrate a protected entrance hallway, Methods 2, 3, or 4, (see [Para 3.7.3.7](#)) may be used.

3.7.3.4 Residential (care facility) Buildings and Residential (Other) Buildings

Ductwork passing through compartment walls or compartment floors of a Residential (care facility) (Purpose Group 2(a), or a Residential (Other) (Purpose Group 2(b) building should be protected in accordance with Method 2 (see [Para 3.7.3.7.2](#)).

3.7.3.5 Ventilation Ducts Passing Between Compartments in Buildings Other Than Residential Buildings or Buildings Containing Flats

Fire protection of ventilation ductwork is needed as an integral part of compartmentation, and to ensure that means of escape from the building are not prejudiced.

Ventilation and air conditioning ducts which pass from one compartment to another should be protected in accordance with Methods 1 to 4 (see [Para 3.7.3.7](#)).

The methods are not mutually exclusive, and it will be found that in most ductwork systems a combination of methods will best combat the potential fire dangers.

Section 3: Internal Fire Spread (Structure)

3.7.3.6 Ventilation Ducts Passing Through Protected Escape Routes

Ventilation and air conditioning ducts which pass through protected escape routes should be protected in accordance with methods 2, 3, or 4 (see [Para 3.7.3.7](#), [Diagram 56](#)).

In single-stairway buildings, the ductwork enclosure should be imperforate (excluding a suitably designed and located maintenance access hatch, which meets the performance of the ductwork protection method) where it passes through the stairway or any protected lobby or protected corridor.

In multi-stairway buildings, ductwork-access panels within protected escape routes should not reduce the fire resistance of the ductwork enclosure from the inside.

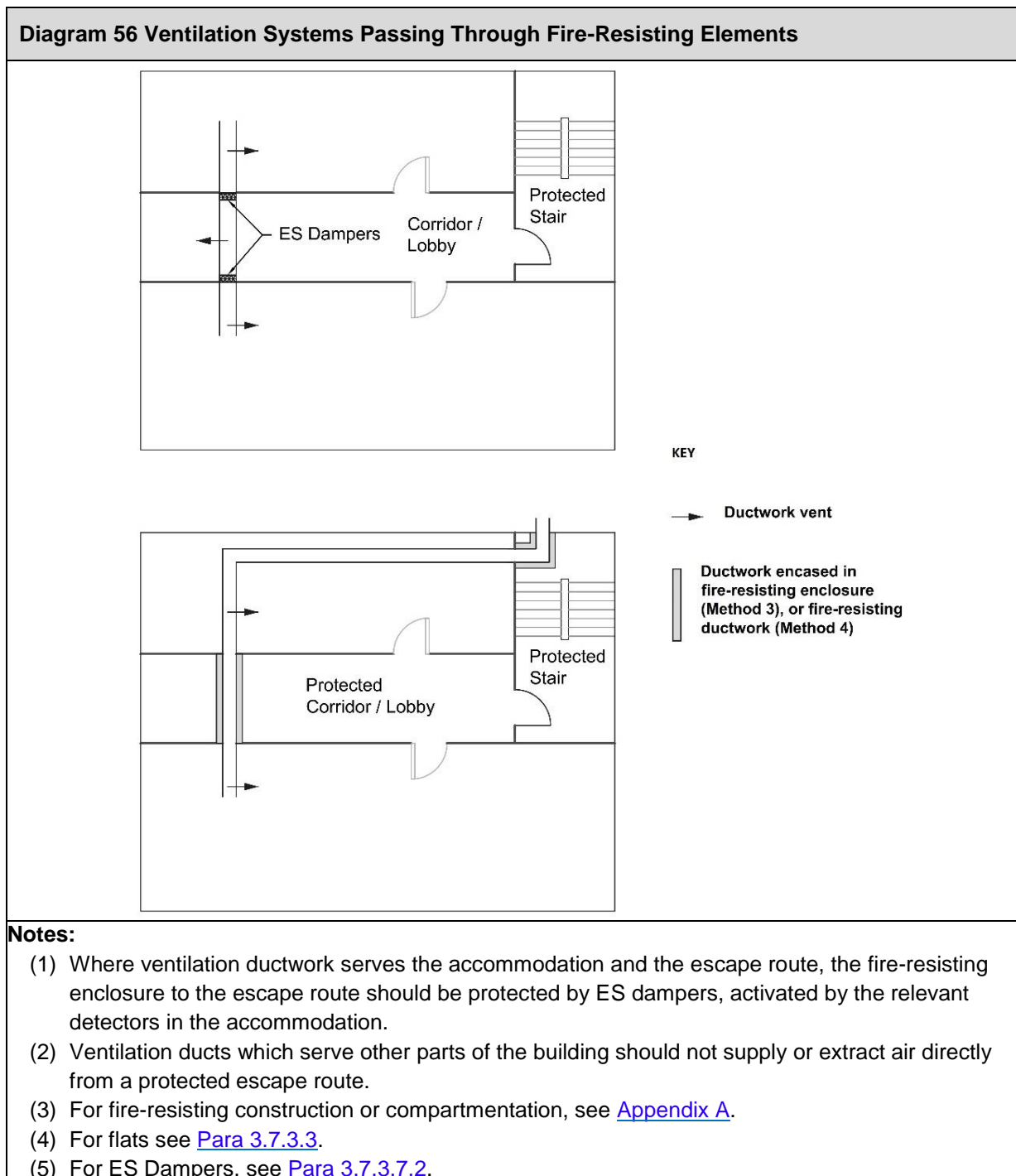

Section 3: Internal Fire Spread (Structure)

3.7.3.7 Methods of Protecting Ventilation Systems Passing Through Fire-Resisting Elements

The methods of protecting ductwork are as follows:

Method 1: Protection using thermally activated fire dampers.

Method 2: Protection using fire and smoke activated fire dampers.

Method 3: Protection using fire-resisting enclosures.

Method 4: Protection using fire-resisting ductwork.

3.7.3.7.1 Method 1: Protection Using Thermally Activated Fire Dampers

Fire dampers should be situated within the thickness of the fire-separating element. To ensure that the damper will not be displaced by movement or collapse of the duct, dampers should be securely fixed and provided with breakaway joints. The damper should be suitably located, and provided with an inspection hatch to facilitate inspection, testing and maintenance of both the fire damper and its actuating mechanism.

Fire dampers should conform to I.S. EN 15650. They should have an E classification equal to the integrity rating of the fire-resisting elements that they are passing through.

Dampers should not be used for extract ductwork serving kitchens as the likely build-up of grease within the duct can adversely affect their operation.

3.7.3.7.2 Method 2: Protection Using Fire and Smoke Activated Fire Dampers

Fire dampers should be situated within the thickness of the fire-separating element. To ensure that the damper will not be displaced by movement or collapse of the duct, dampers should be securely fixed and provided with breakaway joints. The damper should be suitably located, and provided with an inspection hatch to facilitate inspection, testing and maintenance of both the fire damper and its actuating mechanism.

Fire and smoke dampers should conform to I.S. EN 15650. They should have an ES classification equal to the integrity rating of the fire-resisting elements they are passing through.

Fire and smoke dampers should be triggered by smoke detectors.

Dampers should not be used for extract ductwork serving kitchens as the likely build-up of grease within the duct can adversely affect their operation.

Section 3: Internal Fire Spread (Structure)

3.7.3.7.3 Method 3: Protection Using Fire-Resisting Enclosures

The provisions of fire resisting enclosures to ductwork should meet one of the following:

- (a) The fire resistance of the ductwork enclosure when tested from each side should be not less than the fire resistance required for the elements of construction in the area through which it passes.
- (b) The fire resistance of the ductwork enclosure when tested from each side should be not less than half of the fire resistance required for elements of construction in the area through which it passes, and in no case should be less than 30 minutes, if the following is satisfied:
 - (i) there are no materials with a reaction to fire classification worse than A2-s3, d2, such as insulation, between the ductwork and the enclosure; and
 - (ii) the enclosure facings are constructed from materials with a reaction-to-fire classification achieving A2-s3, d2, or better.
- (c) The fire resistance of the ductwork enclosure when tested from the outside should be not less than the fire resistance required for the elements of construction in the area through which it passes, if the following is satisfied:
 - (i) the junction between the floor and the ductwork at every storey level is fire-stopped; and
 - (ii) there are no materials with a reaction to fire classification worse than A2 - s3, d2, such as insulation, between the ductwork and the enclosure; and
 - (iii) the enclosure facings are constructed from materials with a reaction-to-fire classification achieving A2-s3, d2, or better.

3.7.3.7.4 Method 4: Protection Using Fire-Resisting Ductwork

The ductwork system should have a fire resistance (EI), when tested in accordance with I.S. EN 13501-3 from each side, and should be not less than the highest fire resistance required for any element of construction through which it passes.

Where the ductwork serves a commercial kitchen, it should achieve an EI rating. The fire resistance should be from each side and should be not less than the highest fire resistance required for any element of construction through which it passes (see [Appendix A, Table 31](#)).

Where fire-resisting ductwork is provided, the ductwork, along with any associated fixings or support structure of the ductwork should have the necessary fire resistance to ensure its performance.

Section 3: Internal Fire Spread (Structure)

3.7.4 Flue Walls, Ducts Containing Flues, Appliance Ventilation Ducts

Where a flue, or duct containing flues or appliance ventilation duct(s), passes through a compartment wall or compartment floor, or is built into a compartment wall, the wall of the flue or duct should have a fire resistance of at least half that of the wall or floor in order to prevent the bypassing of the compartmentation (see [Diagram 57](#)).

The walls enclosing the flue or duct should be of solid construction composed of materials with a reaction-to-fire classification achieving Class A1. Such walls should not be formed of framed construction.

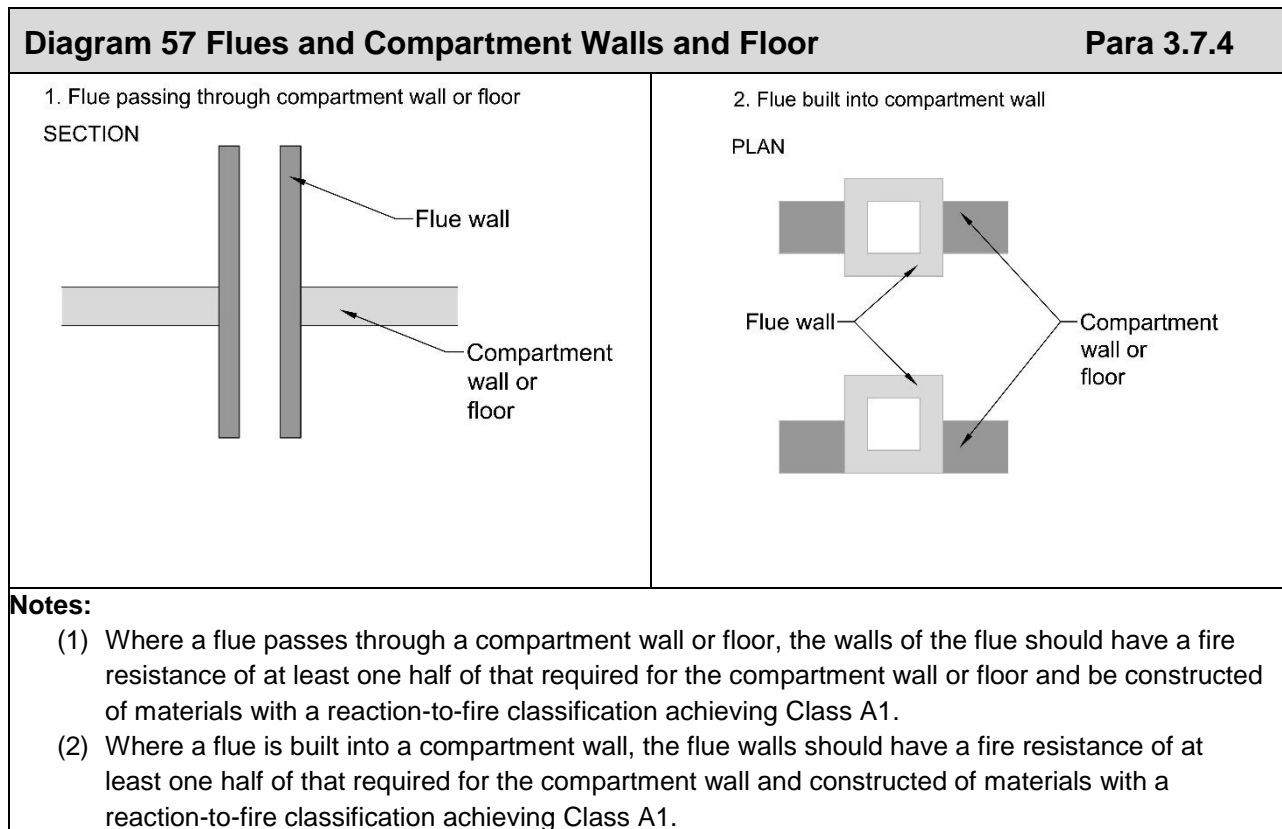

Section 3: Internal Fire Spread (Structure)

3.7.5 Fire-Stopping

In addition to any other provisions in this document for fire-stopping:

- (a) joints between elements which serve as a barrier to the passage of fire should be fire-stopped, allowing for movement where appropriate; and
- (b) all openings for pipes, ducts, conduits or cables to pass through any part of an element which serves as a barrier to the passage of fire should be:
 - (i) kept as few in number as possible; and
 - (ii) kept as small as practicable; and
 - (iii) fire-stopped (which in the case of a pipe or ducts, should allow thermal movement).

3.7.5.1 Displacement

To prevent displacement, materials used for fire-stopping should be reinforced with (or supported by) materials with a reaction-to-fire classification achieving Class A2 - s3, d2, or better, in the following circumstances:

- (a) in all cases where the unsupported span is greater than 100 mm; and
- (b) in any other case where non-rigid materials are used (unless they have been shown to be satisfactory by test).

3.7.5.2 Fire-Stopping Materials

Proprietary sealing systems (including those designed for service penetrations) which have been shown by test to maintain the fire resistance of the wall or other element are also acceptable.

Generic materials suitable for fire-stopping may include the following:

- cement or lime mortar; or
- gypsum-based plaster; or
- cement or gypsum-based vermiculite/perlite mixes; or
- mineral wool, crushed rock, blast furnace slag, ceramic based products (with or without resin binders); or
- intumescent mastics.

These may be used only in situations which are suitable for the particular fire-stopping materials.

Section 3: Internal Fire Spread (Structure)

3.8 Special Provisions

3.8.1 Introduction

This subsection specifies additional provisions, which apply to the design and construction of

- car parks; and
- buildings containing an atrium.

3.8.2 Car Parks

Car parks can be categorised depending on the configuration and manner of ventilation. They may be referred to as being

- 'open-sided' (see Subsection [0.10 Definitions](#)); or
- 'non-open-sided' (see Subsection [0.10 Definitions](#)).

All car parks should comply with [Para 3.8.2.1](#), and:

- (a) For open-sided car parks - [Para 3.8.2.2](#) and the ventilation provisions set out in [Para 6.8.2](#); or
- (b) For non-open-sided car parks - [Para 3.8.2.3](#) and the ventilation provisions set out in [Para 6.8.3](#).

3.8.2.1 Provisions Common to all Car Park Buildings

All materials used in the construction of the building, compartment or separated part forming the car park should be composed of materials with a reaction-to-fire classification achieving Class A1, except for:

- (a) Any surface finish applied to the floor or roof of the car park, however the finish should meet any relevant performance set out in [Section 2](#) or [Section 4](#); or
- (b) Any fire door; or
- (c) Any attendant's kiosk not exceeding 15 m² in area.

3.8.2.2 Open-Sided Car Parks

Where a car park is considered as an open-sided car park, the appropriate periods of fire resistance, specified in [Appendix A, Table 32](#) for an open sided car park should be used.

For the purposes of space separation in [Section 4, Table 21](#) an open-sided car park building may be regarded as a small building or compartment.

3.8.2.3 Car Parks which are not Open-Sided

Where a car park is considered not open-sided, the appropriate periods of fire resistance, for a non-open sided car park specified in [Appendix A, Table 32](#) should be used.

Such a non-open sided car park should be ventilated by natural or mechanical means (see Section 6 - [Para 6.8.3.1](#), or [Para 6.8.3.2](#)).

Section 3: Internal Fire Spread (Structure)

3.8.3 Buildings Containing an Atrium

Many large modern buildings contain an atrium, which is a large undivided space penetrating a compartment floor within a building (see Subsection [0.10 Definitions](#)). Storeys in the building may be open to the atrium, or they may be separated by fire-resisting construction. In the absence of any contrary provisions, fire resistance of elements separating the atrium from associated floor areas should be taken as being tested from each side.

The provision of an atrium, will therefore impact on compartmentation, with the possibility of fire spread. The provisions outlined in Para's 3.8.3.2 to 3.8.3.6 will apply only where an atrium passes through such a compartment floor.

Where there is an open connection between floors, and where the open connection does not penetrate any compartment floor, the provisions of [Para 1.4.3.4](#) are applicable.

Where smoke retarding construction has been provided to enclose the atrium, to address escape close to the void edge, in addition to the relevant provisions set out in the following paragraphs, the provisions of [Para 1.4.3.4](#) with respect to escape away from the void edge do not apply.

The accumulation of smoke which enters the atrium will also impact on the means of escape provisions (see [Section 1](#)).

Provisions relating to smoke control systems are contained in [Section 6](#).

3.8.3.1 Smoke-Retarding Construction

In many instances, it is not necessary to enclose the atrium with fire-resisting construction.

However, a smoke-retarding enclosure may be required to prevent the early ingress of smoke to those levels that are not directly affected by fire. Some forms of construction which are fire-resisting (e.g. traditional roller shutters) would not be sufficiently impervious to smoke to be considered as smoke-retarding.

Where the maximum possible smoke temperature is no more than 200 °C then laminated or toughened glazed systems using glazing sealants may be used to form a smoke-retarding enclosure, provided that there is no risk of fire and flame exposure from either side of the glazing. Where higher smoke temperatures are likely then either a classified fire-resisting glazed system tested in accordance with I.S. EN 1364-1 should be used, or an assembly conforming to I.S. EN 12101-1.

Where smoke curtains are used, they should be in accordance with I.S. EN 12101-1. In the absence of an appropriate method of test and performance criteria, such construction should not contain unsealed joints and permanently open or openable areas. Joints between such construction and any abutting element should be tight and sealed with a filler conforming to I.S. EN 1366-3 or I.S. EN 1366-4 (e.g. plaster), a mastic, or a flexible strip (e.g. neoprene), as appropriate.

Section 3: Internal Fire Spread (Structure)

Any doors set in smoke retarding construction, should conform to [Appendix B, Table 36](#).

If the glazed construction is required to carry out a fire-separation function, when directly affected by fire, then it should be fire resisting, for either fire-integrity or fire-insulation performances, as appropriate.

3.8.3.2 Atria in Buildings Containing Flats

For atria in buildings containing flats (Purpose Group 1(c)), with a height of up to 18 m, all the following provisions apply:

- (a) The building should be designed for simultaneous evacuation.
- (b) The means of escape from each flat should be designed as per the equivalent non-atrium building (see [Subsection 1.6](#)).
- (c) Escape routes from individual flats should be independent from the atrium.
- (d) The fire-detection and alarm system should be a Category L3X system, installed throughout the building in accordance with [Para 1.9.13](#).
- (e) The accommodation should be separated from the atrium by 60-minute (EI) fire-resisting construction, which should be smoke-retarding.
- (f) A smoke clearance system (see [Para 6.4.2](#)) should be provided within the atrium.
- (g) Private balconies may be unenclosed.
- (h) The wall between units and the atrium should be constructed in accordance with the relevant provisions for an external wall (see [Section 3, Section 4](#)).

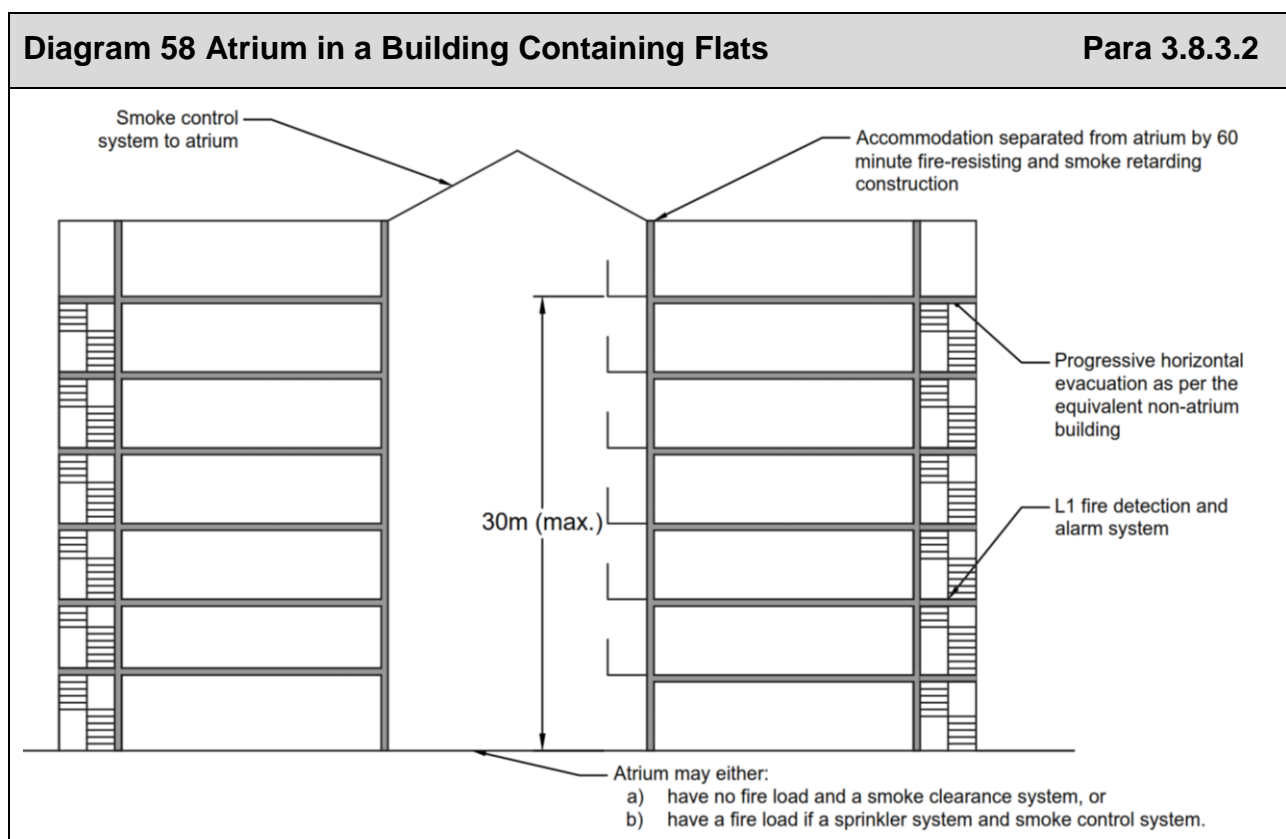

Section 3: Internal Fire Spread (Structure)

3.8.3.3 Atria in Residential (Care Facility) Buildings

For atria in residential (care facility) building (Purpose Group 2(a)) with a height of up to 30 m, all the following provisions apply:

- (a) The evacuation strategy should be designed for progressive horizontal evacuation, equivalent to a non-atrium building.
- (b) The fire-detection and alarm system should be a Category L1 system, installed throughout the building in accordance with [Para 1.9.13](#).
- (c) The atrium should be enclosed in 60-minute (EI) fire-resisting construction, which should be smoke-retarding (see [Para 3.8.3.1](#)).
- (d) Either
 - (i) the atrium base should have no fire load, and a smoke-clearance system should be provided (see [Para 6.4.2](#)); or
 - (ii) a sprinkler system (see [Para 8.4.2](#)) should be provided to the atrium base, and a smoke-control system should be provided to the atrium (see [Para 6.4.3](#)).

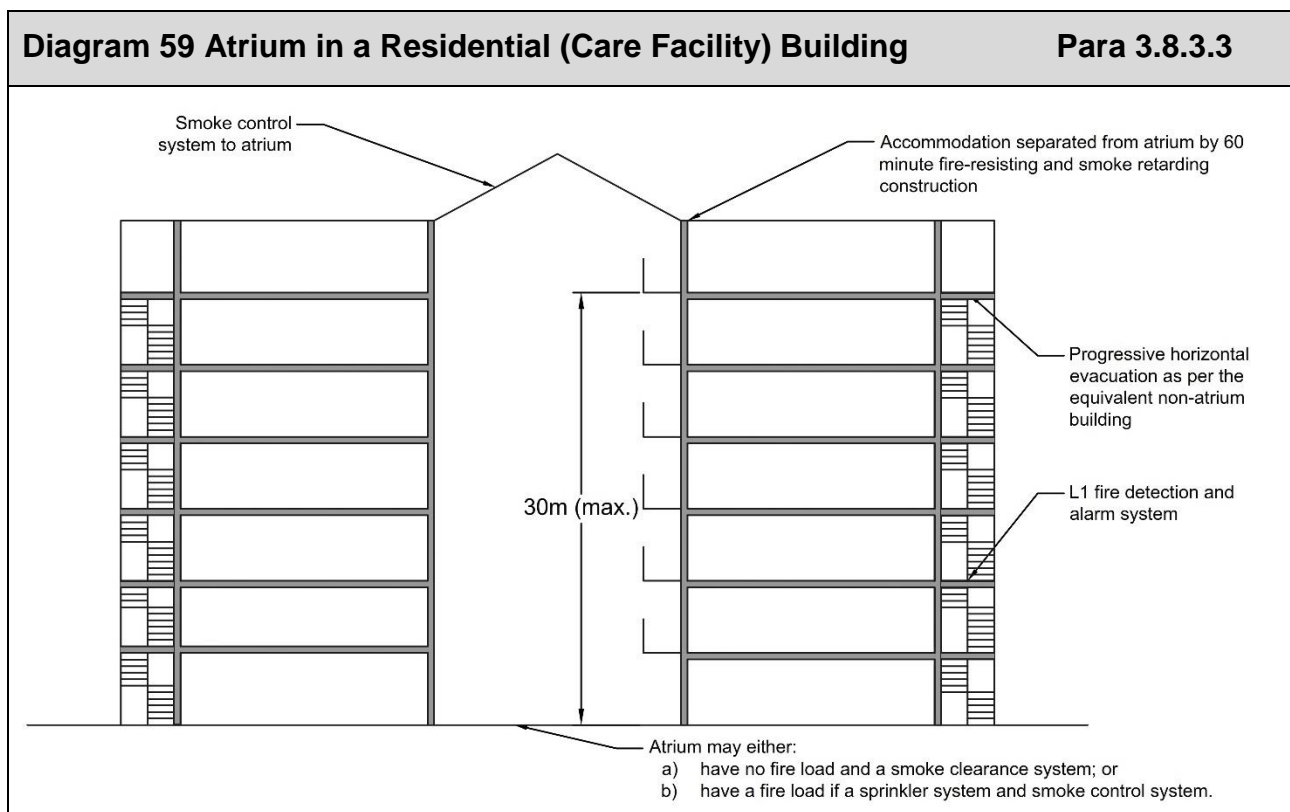

Section 3: Internal Fire Spread (Structure)

3.8.3.4 Atria in Residential (Other) Buildings

For atria in a residential (other) building (Purpose Group 2(b)) with a height of up to 60 m, all the following provisions apply:

- (a) Escape should be independent of the atrium.
- (b) The building should be designed for simultaneous evacuation.
- (c) Travel distances to storey exits should conform to [Subsection 1.4](#).
- (d) The fire-detection and alarm system should be a Category L1 system with voice alarm, installed throughout the building in accordance with [Para 1.9.13](#).
- (e) The accommodation should be separated from the atrium by 30 minutes (EI) fire-resisting construction, which should be smoke-retarding (see [Para 3.8.3.1](#)).
- (f) A natural or mechanical smoke-clearance system should be provided within the atrium, where the atrium height is < 30 m (see [Para 6.4.2](#)).
- (g) A mechanical smoke clearance system should be provided within the atrium, where the atrium height is > 30 m (see [Para 6.4.2](#)).
- (h) A fire load may be within the atrium, provided that it is controlled by means of a sprinkler system (see [Para 8.4.3](#)).

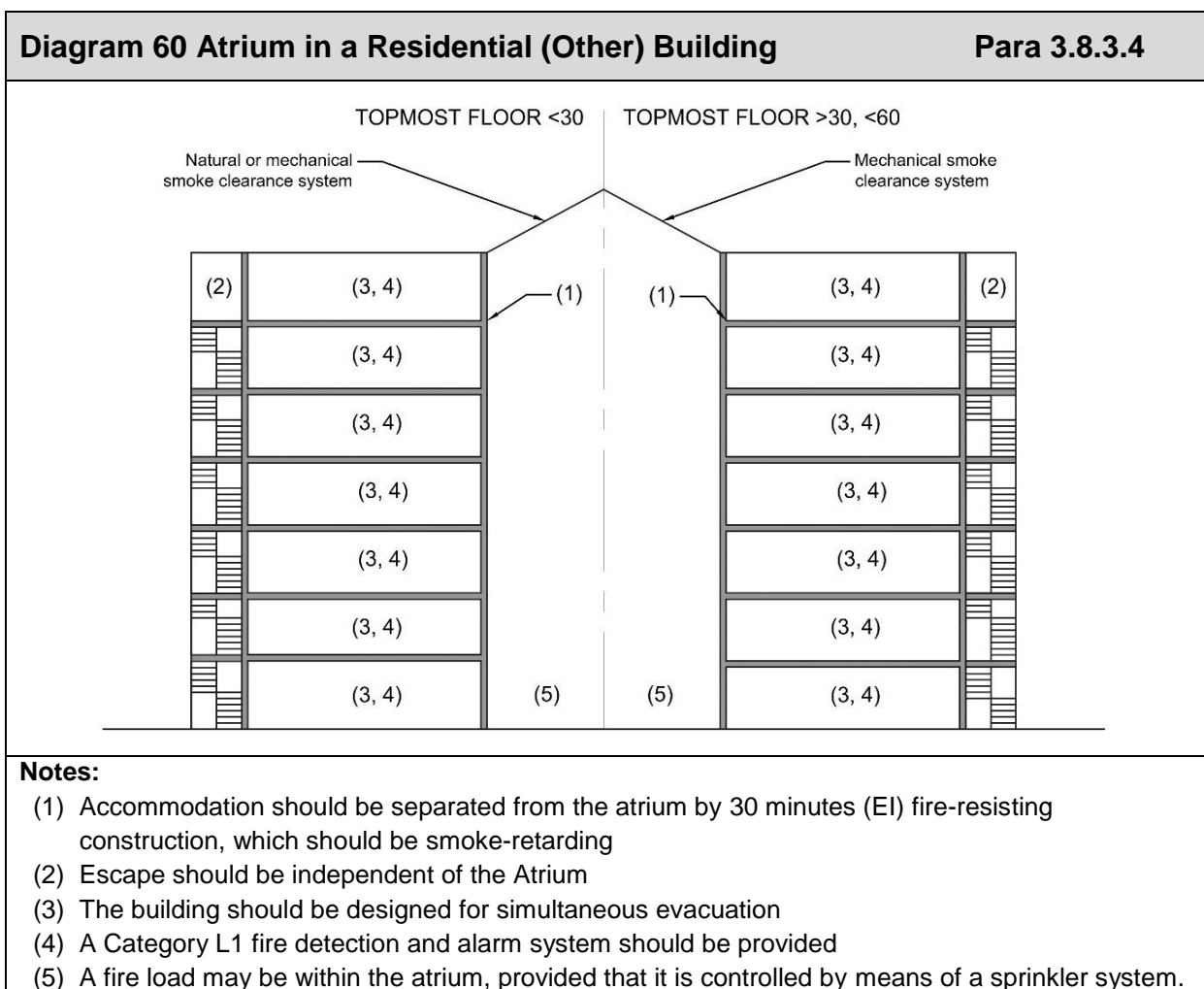

Section 3: Internal Fire Spread (Structure)

3.8.3.5 Atria in Shops, Assembly and Recreation Buildings, and Other Non-Residential Buildings

The specific performance requirements for atria in shops, assembly and recreation buildings, and other non-residential buildings (Purpose Groups 4(a), 5, 8) depend on the height of the atrium, and whether the atrium is open, or partially open.

3.8.3.5.1 Atria Which Are < 18 m in Height, and are Open

All the following provisions apply:

- (a) Escape routes should not pass within 5m of the atrium (see [Para 1.4.3.5](#), [Diagram 5](#)).
- (b) The fire-detection and alarm system should be a Category L3/L2 system, with voice alarm installed throughout the building in accordance with [Para 1.9.13](#).
- (c) The building should be designed for simultaneous evacuation.
- (d) A smoke control system should be provided within the atrium (see [Para 6.4.3](#)).
- (e) A sprinkler system (see [Para 8.4.4](#)) should be provided in associated floor areas of the atrium.
- (f) A fire load may be within the atrium base, provided that it is controlled by means of a sprinkler system (see [Para 8.4.4](#)).

3.8.3.5.2 Atria Which Are < 18 m, and Are Partially Open

For atria with a height of less than 18m in shops, assembly and recreation buildings, and other non-residential buildings (Purpose Groups 4(a), 5, 8), where upper atrium storeys are enclosed to form a reservoir, the atrium is described as “partially open”.

The upper enclosed storeys should be separated from the atrium by 30-minute fire-resisting construction (EI) which should be smoke-retarding. All the requirements of [Para 3.8.3.5.1](#) (b) – (f) above also apply to such an atrium, and requirement (a) applies to all floors which are not fully separated from the atrium by the required fire-resisting construction.

Section 3: Internal Fire Spread (Structure)

3.8.3.5.3 Atria Which Are > 18 m in Height, and Open

All the following provisions apply:

- (a) Escape routes should not pass within 5 m of the atrium (see [Para 1.4.3.5](#), [Diagram 5](#)).
- (b) The fire-detection and alarm system should be a Category L3/L2 system, with voice alarm installed throughout the building in accordance with [Para 1.9.13](#).
- (c) The building should be designed for simultaneous evacuation.
- (d) Smoke removal should be provided from each floor.
- (e) A sprinkler system (see [Para 8.4.4](#)) should be provided in associated floor areas of the atrium.
- (f) The atrium base should have no fire load.

3.8.3.5.4 Atria Which Are > 18 m in Height, Not Open

All the following provisions apply:

- (a) The enclosure should be of smoke retarding construction.
- (b) The fire-detection and alarm system should be a Category L3/L2 system, with voice alarm installed throughout the building in accordance with [Para 1.9.13](#).
- (c) The building should be designed for simultaneous evacuation.
- (d) A natural or mechanical smoke-clearance system should be provided within the atrium, where the atrium height is < 30 m (see [Para 6.4.2](#)).
- (e) A mechanical smoke clearance system should be provided to an atrium should be provided within the atrium, where the atrium height is > 30 m (see [Para 6.4.2](#)).
- (f) Construction separating associated floor areas from the atrium located above 30 m should achieve 60-minute fire resistance.
- (g) Construction separating associated floor areas from the atrium located below 30 m should achieve 30-minute fire resistance.
- (h) A sprinkler system should be provided in associated floor areas of the atrium.
- (i) A fire load may be within the atrium base, provided that it is controlled by means of a sprinkler system (see [Para 8.4.4](#)).

Section 3: Internal Fire Spread (Structure)

Diagram 61 Atrium in a Shop, Assembly and Recreation or Other Non-residential Building

Para 3.8.3.5

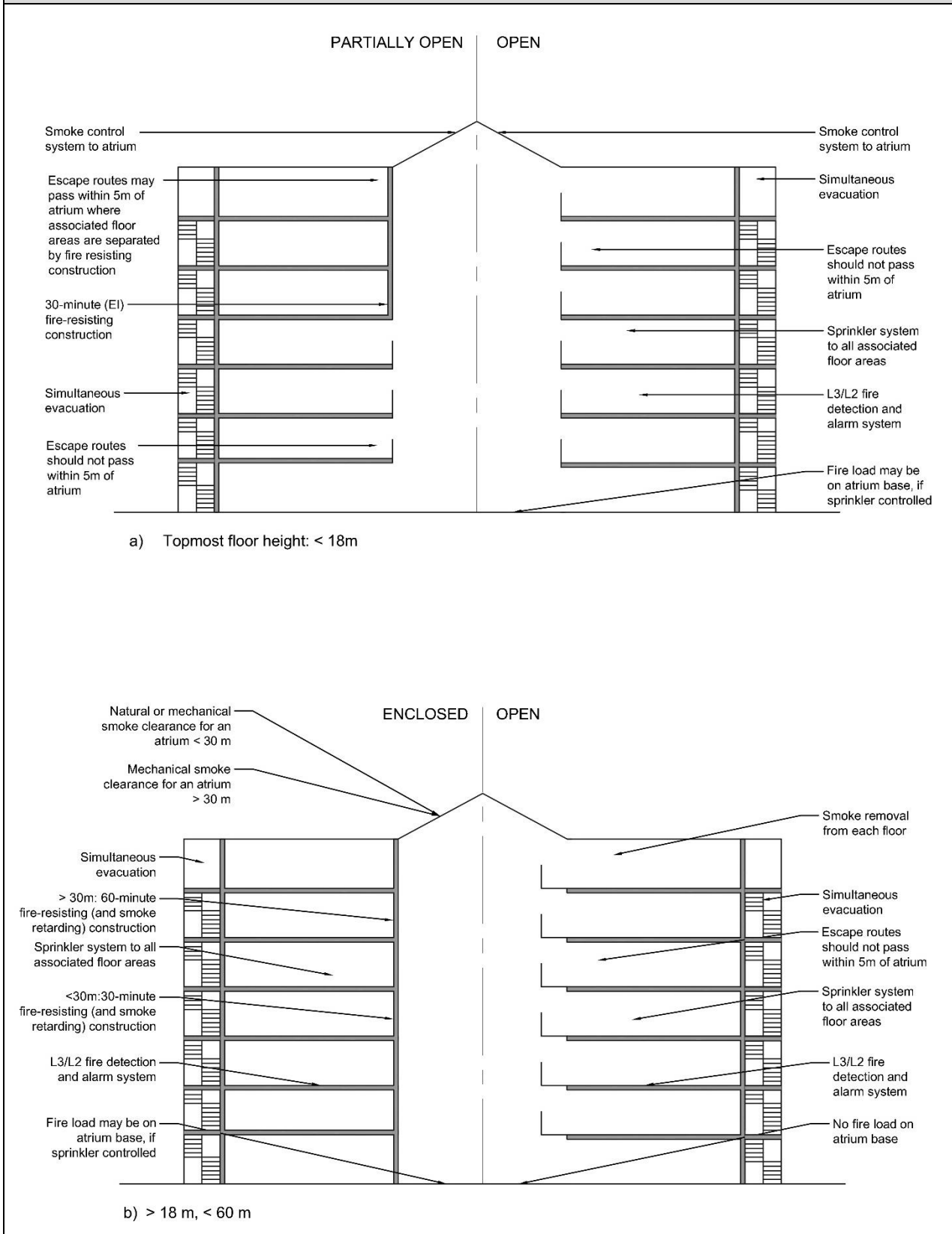

Section 3: Internal Fire Spread (Structure)

3.8.3.6 Atria in Offices

The specific performance requirements for atria in offices (Purpose Group 3) depend on the height of the atrium, and whether the atrium is open, or partially open.

3.8.3.6.1 Atria <30m in Height

For office buildings (Purpose Group 3) where the atrium is open, or partially open, all the following provisions apply:

- (a) Escape routes should not pass within 5m of the atrium (see [Para 1.4.3.5](#), [Diagram 5](#)).
- (b) The fire-detection and alarm system should be a Category L3/L2 system, installed in accordance with [Para 1.9.13](#), with alarm throughout the building.
- (c) The building should be designed for simultaneous evacuation.
- (d) For atria <18m, the atrium should be enclosed at the top storey smoke retarding construction (see [Para 3.8.3.1](#)), or a reservoir of equivalent volume should be formed at the top of the atrium.
- (e) For atria >18m, but not exceeding 30m, the atrium should be enclosed at the top two storeys by smoke retarding construction (see [Para 3.8.3.1](#)), or a reservoir of equivalent volume should be formed at the top of the atrium.
- (f) A smoke-clearance system should be provided within the atrium (see [Para 6.4.2](#)).
- (g) The fire load in the atrium base may be comparable to the use and contents of the floor areas adjoining the atrium.

Requirement (a) above applies to all floors which are not fully separated from the atrium by the required fire-resisting construction.

3.8.3.6.2 Atria >30m in Height

For office buildings (Purpose Group 3), the following provisions apply:

- (a) The atrium may be open or enclosed. Where enclosed the construction should be 30-minute fire-resisting construction (EI) which should be smoke-retarding (see [Para 3.8.3.1](#)).
- (b) For atria that are open, escape routes should not pass within 5m of the atrium (see [Para 1.4.3.5](#), [Diagram 5](#)).
- (c) The fire-detection and alarm system should be a Category L3/L2 system, installed in accordance with [Para 1.9.13](#), with alarm throughout the building.
- (d) The building should be designed for simultaneous evacuation.
- (e) For atria which are open, provide atrium pressurisation or smoke removal from each floor
- (f) For atria that are enclosed, provide mechanical smoke clearance from the atrium.
- (g) The fire load in the atrium base may be comparable to the use and contents of the associated floor areas adjoining the atrium.

Section 3: Internal Fire Spread (Structure)

- (h) A sprinkler system (see [Para 8.4.4](#)) should be provided in associated floor areas of the atrium.

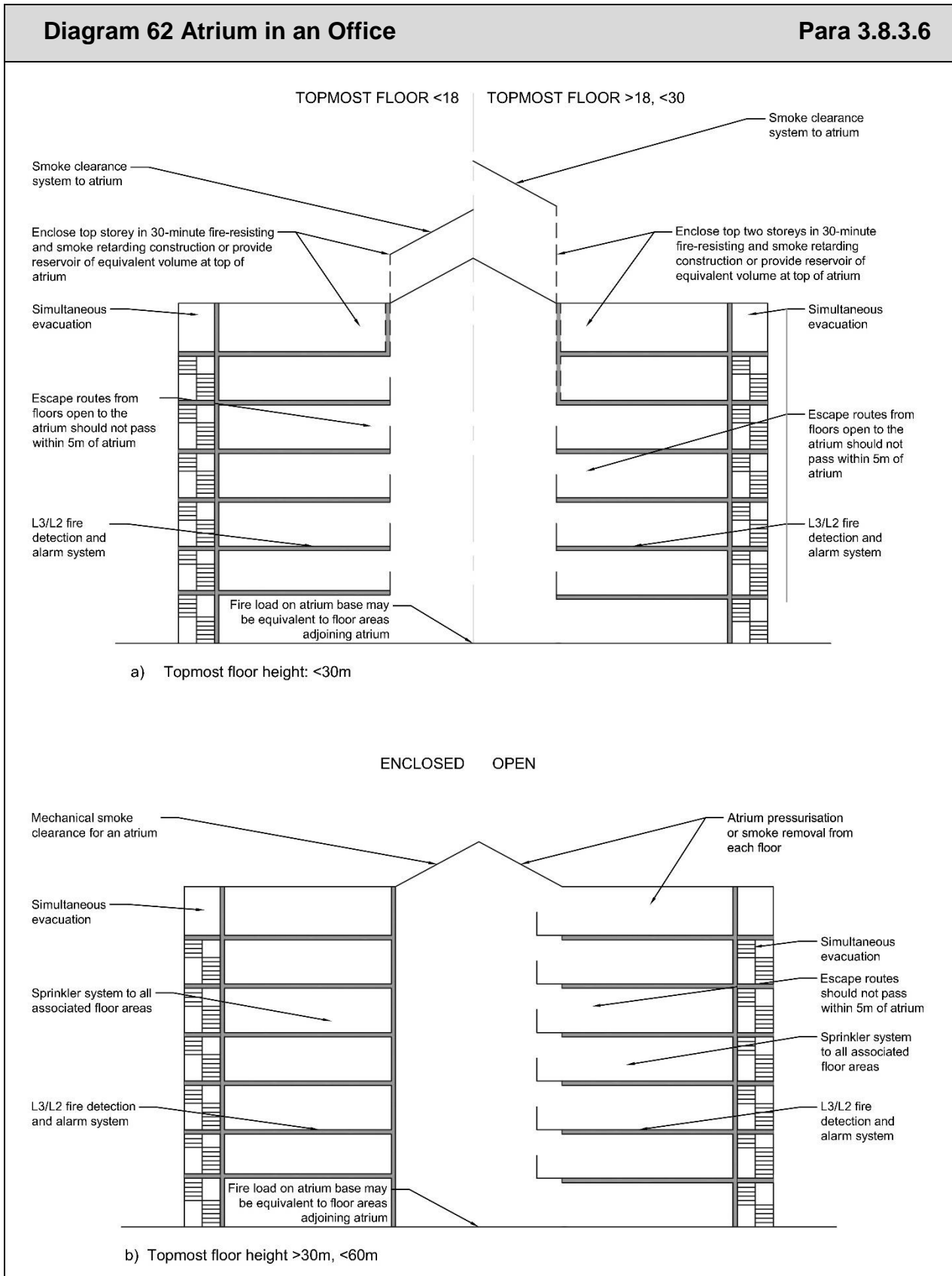

Section 4 External Fire Spread

4.1 General

The guidance in this section shows compliance with Part B of the Second Schedule to the Building Regulations, in particular Regulation B4. Limiting fire spread on the surface of the building also assists in maintaining adequate compartmentation, as outlined in [Section 3](#).

These requirements may be achieved:

- (a) if the external walls and elements attached to external walls are constructed so that they inhibit fire spread from one part of a building to another part of the same building; and
- (b) if the external walls are constructed so that the risk of ignition from an external source and the spread of fire over their surfaces, is restricted by making provision for them to have low rates of spread of flame, and in some cases low rates of heat release; and
- (c) if the amount of unprotected area in the side of the building is restricted so as to limit the amount of thermal radiation that can pass through the wall, taking the distance between the wall and the boundary into account; and
- (d) if the roof is constructed so that the risk of spread of flame and/or fire penetration from an external fire source is restricted.

In each case so as to limit the risk of a fire spreading from the building to other parts of the same building or to a building beyond the boundary, or vice versa.

The extent to which this is necessary is dependent on the use of the building, on the distance from the boundary and, in some cases, on its height.

4.2 Introduction to Provisions

The construction of external walls and the separation between buildings to prevent external fire spread are closely related.

The chances of fire spreading from one part of a building to another part of the same building and across an open space between buildings is dependent on:

- (a) the size and intensity of the fire in the building concerned; and
- (b) the distance between the buildings; and
- (c) the fire resistance of the external wall construction; and
- (d) the fire characteristics of the materials from which the external wall is constructed, such as reaction to fire.

Subsections 4.3 to 4.5 specify the minimum provisions for the building to meet these requirements.

Section 4: External Fire Spread

4.3 External Walls

4.3.1 Introduction

Provisions are made in this Section for the external walls (see [Diagram 63](#)) of the building to have sufficient fire resistance from the inside, including integrity and insulation as well as stability to prevent fire spread between parts of the building and across the relevant boundary (see [Diagram 65](#)).

The provisions are closely linked with those for space separation in [Subsection 4.4](#) which sets out limits on the amount of wall area that need not be fire resisting (This is termed “unprotected area”). As the limits depend on the distance of the wall from the relevant boundary, it is possible for some, or all, of the walls to be permitted to have no fire resistance except for any parts which are load-bearing or any parts that contribute to compartmentation (see [Para 3.5.10](#)).

However, the total amount of combustible material may be limited in practice by the provisions for space separation in [Subsection 4.4](#) (see [Para 4.4.3.1](#)).

Fire resistance from the outside is dependent on space separation and the relevant boundary, and on whether the wall is within 1 m of the relevant boundary.

Provisions are also made to restrict the amount of combustible surfaces on buildings. This is in order to reduce the susceptibility to ignition of the surface of the building and to reduce the possibility of fire spread on the external face of the building.

Under Section 3, provisions are made in [Subsection 3.3](#) for internal and external load-bearing walls to maintain their load-bearing function in the event of fire. This is a requirement for stability only.

4.3.2 Fire Resistance of External Walls

The external walls of the building should have the appropriate fire resistance given in [Appendix A, Table 31](#), unless they are permitted to form an unprotected area under [Subsection 4.4](#).

However, where there is a fire-resistance requirement specified for compartmentation (see [Para 3.5.10](#), [Para 3.5.11](#), [Diagram 48](#), [Diagram 49](#)), this should be maintained.

Section 4: External Fire Spread

4.3.3 Restriction of Fire Spread on External Walls

The external wall of the building or elements external to the building should not provide a medium for fire spread. The use of combustible materials for cladding framework, or of combustible thermal insulation as an over-cladding, may present a risk in buildings.

As an overarching requirement, for buildings of any height or use, appropriate consideration should be given in the selection of materials or systems used for the external wall, or elements fixed to the external wall, to reduce the risk of fire spread over the face of the wall. This may be proven by full-scale test to BS 8414, achieving the performance as specified in BR 135.

Where a building contains separate purpose groups, the most onerous requirements apply. However, where buildings are separated by separating walls, or form separated parts, the requirements of the individual purpose groups apply to that building.

4.3.3.1 Buildings with a Topmost Floor Height of less than 15 m

For buildings with a topmost floor height of less than 15 m (see [Diagram 91](#)), when measured in accordance with Appendix C, the reaction to fire performance of the external surface of the walls (the outermost material forming the wall) should meet the provisions specified in [Table 19](#).

4.3.3.2 Buildings with a Topmost Floor Height of more than 15m

For buildings with a topmost floor height of more than 15 m (see [Diagram 91](#)), when measured in accordance with Appendix C, the external walls, with the exception of materials specified in [Para 4.3.3.3](#), should meet the provisions as specified [Table 19](#) (see [Diagram 64](#)).

Elements fixed to the external wall (excluding a roof with a pitch at more than 70° to the horizontal, adjoining a habitable room) of the building (such as an open balcony, a device for reducing heat gain, a solar panel or materials which support and contain growing media in a green wall) should also meet the provisions as specified in [Table 19](#).

Where the products of the wall construction do not achieve the fire characteristics as specified in [Table 19](#) and [Diagram 64](#), compliance should be proven by full-scale test to BS 8414, achieving the performance as specified in BR 135. Where such a system is being used, it must conform to the specific construction that was tested to BS 8414, and be certified as such by a competent person.

Section 4: External Fire Spread

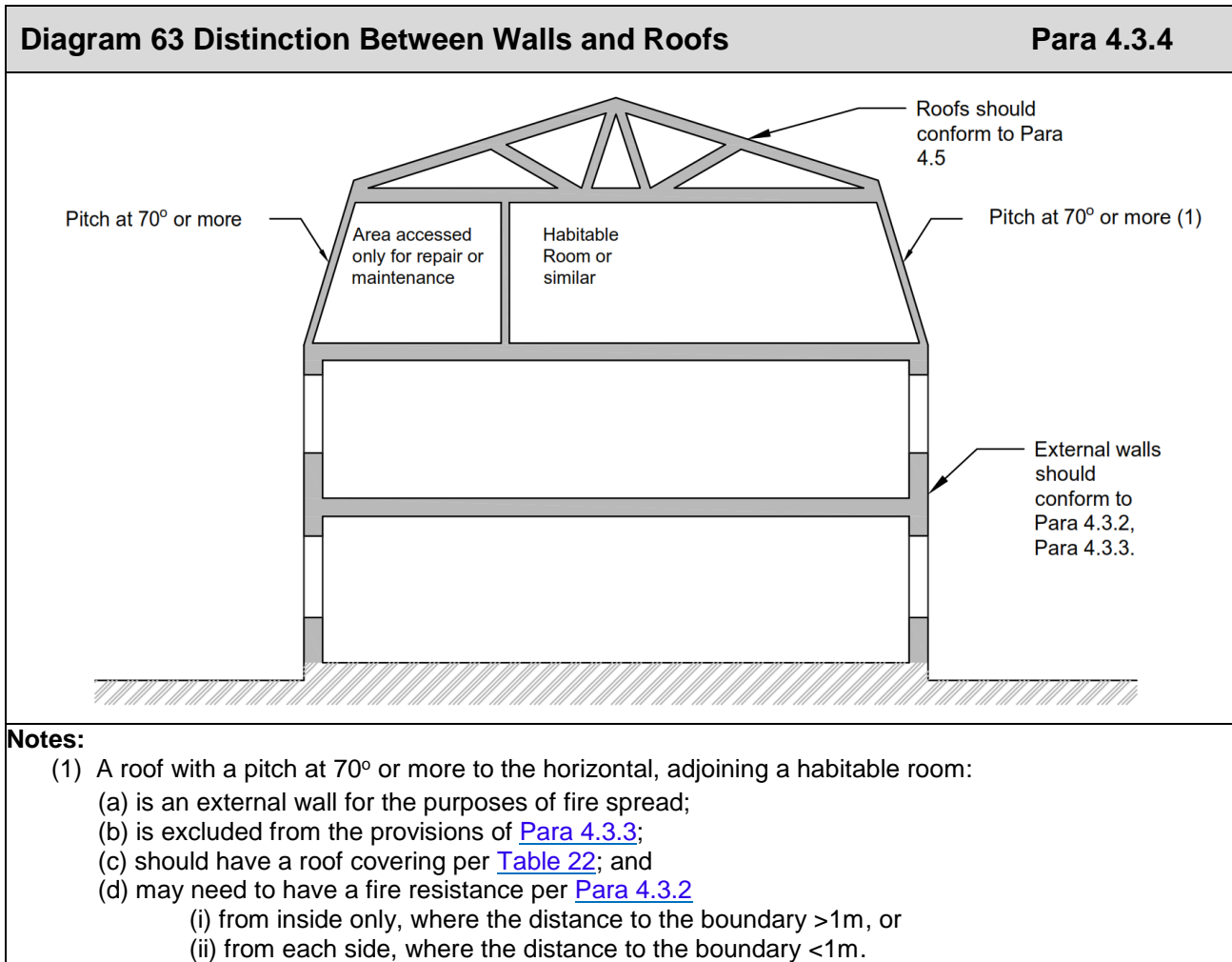
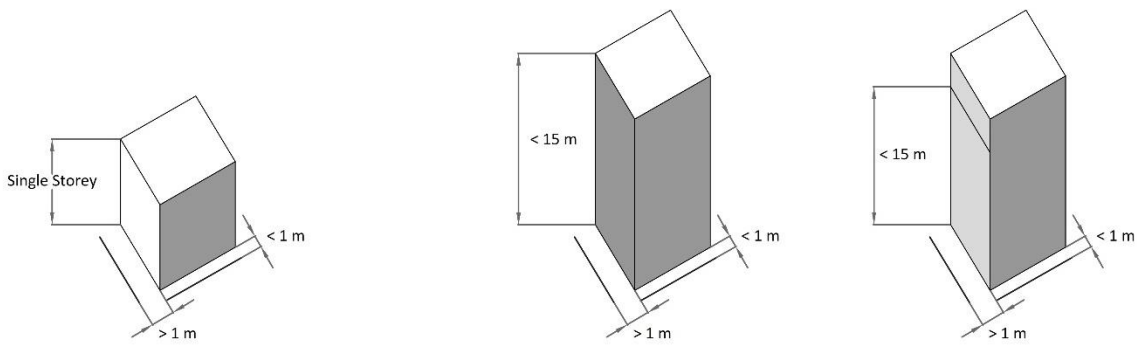

Table 19 Reaction-to-fire Classification for External Walls			
Purpose Group	Height of topmost storey	Less than 1m to relevant boundary ⁽⁵⁾	More than 1m to relevant boundary ⁽⁵⁾
2a, 2b, 3, 4, 5, 6, 7, 8	Single storey	Class B-s3, d2 ⁽²⁾	No requirement
2a	More than one storey, < 15 m	Class B-s3, d2 ⁽²⁾	Class B-s3, d2 ⁽¹⁾⁽²⁾
3, 4, 6, 7, 8	More than one storey, < 15 m	Class B-s3, d2 ⁽²⁾	Class C-s3, d2 ⁽¹⁾⁽²⁾
3, 4, 6, 7, 8	More than one storey, > 15 m	Class B-s3, d2 ⁽³⁾⁽⁴⁾⁽⁶⁾	Class B-s3, d2 ⁽³⁾⁽⁴⁾⁽⁶⁾
1c, 2b, 5	More than one storey, < 15 m	Class B-s3, d2 ⁽²⁾	Class C-s3, d2 ⁽¹⁾⁽²⁾
1c, 2a, 2b, 5	More than one storey, > 15 m	Class A2-s3, d2 ⁽³⁾⁽⁴⁾	Class A2-s3, d2 ⁽³⁾⁽⁴⁾
<p>Notes:</p> <p>(1) Timber cladding at least 9mm thick is also appropriate where fixed directly to a substrate composed of materials with a reaction-to-fire classification achieving A1.</p> <p>(2) Applicable only to the outermost wall element.</p> <p>(3) Applicable to the whole wall build-up, and to elements fixed to the external wall</p> <p>(4) Balcony floors should achieve a 'fl' classification under I.S. EN 13501-1.</p> <p>(5) In a building with a topmost floor > 15 m high, (see Diagram 91) insulation material used in drained and/or ventilated cavities in the external wall construction should have a reaction to fire classification of Class A2-s3, d2 or better.</p>			

Section 4: External Fire Spread

Diagram 64 Provision for External Surfaces of Walls

Para 4.3.3



(a) All uses - single-storey throughout

(b) Residential (Institutional) - <math>< 15\text{ m}</math>

(d) Office, shop, shopping centre, industrial, storage, other non-residential - multi-storey (<math>< 15\text{ m}</math>)

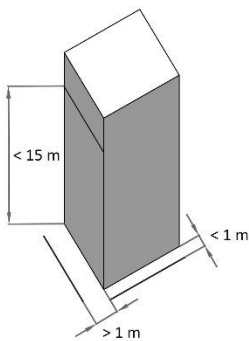

(d) Office, shop, shopping centre, industrial, storage, other non-residential - multi-storey (> 15m)

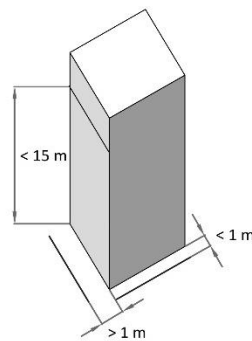

(e) building containing flats, Residential (Other), Assembly and Recreation, Day centre <math>< 15\text{ m}</math>

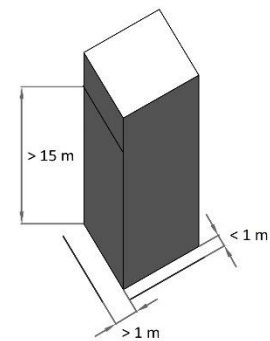

(e) building containing flats, Residential (Institutional), Residential (Other), Assembly and Recreation, Day centre > 15m

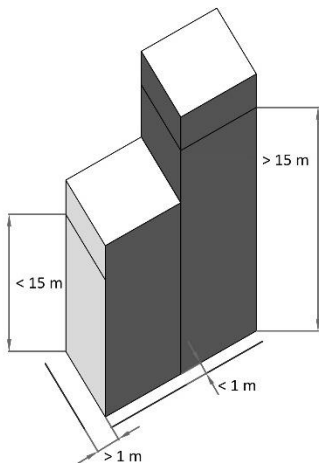

Example 1: Building containing flats (PG 1(c)) of differing heights, not divided by separating walls / not forming separated parts

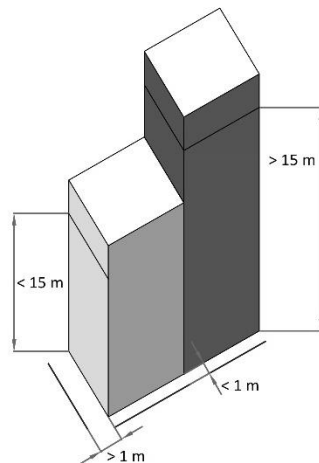

Example 2: Buildings containing flats (PG 1(c)) of differing heights, divided by separating walls / forming separated parts

KEY

- Relevant boundary
- No provision in respect of the boundaries indicated.
- Class C or better
- Class B or better
- Class A2 or better

For smoke production and flaming droplet production classification - see Table 4.1

Notes:

- (1) Where a building is comprised of parts with differing requirements, e.g. single-storey and multi-storey, different purpose groups, and where the parts are separated by compartment walls only, then the most onerous requirements apply to the whole building. Where a building of differing requirements is separated by separating walls, then the requirements should be applied to the individual parts.
- (2) For buildings with a topmost floor height of > 15 m, all relevant materials which make-up the external wall, including cladding systems, should achieve the required performance set out in [Table 19](#).
- (3) Compliance may also be proven by test to BS 8414 demonstrating that the external wall build-up would achieve the performance specified in BR 135.

Section 4: External Fire Spread

4.3.3.3 Materials Excluded from the Provisions

The following materials are excluded from the provisions of [Para 4.3.3.2](#):

- (a) The element facing a habitable room that forms the innermost surface of an external wall, provided that the lining conforms to [Section 2](#). This provision applies to the lining element, e.g. plasterboard, and not to any combination of elements e.g. combined plasterboard and insulation. For such a product, where the topmost floor height of the building is > 15 m, the insulation layer should meet the provisions of [Para 4.3.3.2](#); or
- (b) Cavity trays, or insulating material, when used between two leaves of masonry or concrete of at least 75mm; or
- (c) Any part of a roof that is pitched at an angle of 70° or more to the horizontal adjoining an area to which people have access (excluding access solely for the purposes of repair and maintenance); or
- (d) Door frames and doors; or
- (e) Paint applied to the outermost face of the wall; or
- (f) Pipes and cables used to distribute power or services; or
- (g) Insulation and water-proofing materials used at or below DPC level; or
- (h) Roof flashings and any roof membranes designed to prevent water ingress to the roof; or
- (i) Intumescent and fire-stopping materials where the inclusion of the materials is necessary to meet the requirements of Part B; or
- (j) Membranes; or
- (k) Seals, gaskets, fixings, sealants and backer rods; or
- (l) Thermal break materials where the inclusion of the materials is necessary to meet the thermal bridging requirements of Part L; or
- (m) Window frames and glass (including laminated glass); or
- (n) Vents penetrating the external wall; or
- (o) Thermal insulation applied to the inner face of parapet walls on flat roofs.

Section 4: External Fire Spread

4.3.4 Roofs with a pitch at 70° or more to the horizontal

4.3.4.1 Adjoining Habitable Rooms

A roof with a pitch at 70° or more to the horizontal (see [Diagram 63](#)), adjoining a habitable room:

- (a) is excluded from the provisions of [Para 4.3.3](#); and
- (b) Should conform to the provisions of [Section 4.4](#) and may need to have a fire resistance:
 - (i) from inside only, where the distance to the boundary > 1 m, or
 - (ii) from each side, where the distance to the boundary <1 m; and
- (c) should have a roof covering as per the provisions of [Subsection 4.5](#).

Provisions with respect to elements fixed to the external wall do not apply to such a roof.

4.3.4.2 Adjoining Non-habitable spaces

A roof with a pitch at 70° or more to the horizontal, adjoining a non-habitable space:

- (a) is excluded from the provisions of [Para 4.3.3](#); and
- (b) should have a roof covering as per the provisions of [Subsection 4.5](#).

Provisions with respect to elements fixed to the external wall do not apply to such a roof.

4.3.5 Portal Frames

Portal frames are often used in single-storey industrial and commercial buildings where there may be no requirement for fire resistance of the structure. However, where the building is near a relevant boundary, then the provisions in [Para 4.3.2](#) require the external wall and any structural elements supporting the wall to be fire resisting.

It is generally accepted that a portal frame acts as a single element because of the moment-resisting connections used, especially the column/rafter joints. Thus the rafter members of the frame, as well as the column members may need to be fire-protected in cases where the external wall of the building cannot be wholly unprotected.

Where a portal frame supports an external wall that requires fire resistance, it must either

- (a) have a fire resistance as set out under Appendix A, or
- (b) be designed such that the collapse of part of the portal frame will not result in the collapse of any part of the portal frame supporting the wall.

Further guidance can be found in *Single Storey Steel Framed Buildings in Fire Boundary Conditions*, published by the Steel Construction Institute.

Section 4: External Fire Spread

4.4 Space Separation

4.4.1 Introduction

The provisions in this section limit the extent of openings and other unprotected areas in the sides of the building (including areas with a combustibile surface) which will not give adequate protection against the spread of fire to another building. The provisions assume:

- (a) that the size of the fire will depend on the compartmentation of the building, so that the fire will involve a complete compartment, but will not spread across lines of compartmentation; and
- (b) that the intensity of the fire is related to the use of the building (i.e. its purpose group), but that it can be moderated by a sprinkler system; and
- (c) that residential (Purpose Groups 1(c), 2(a), 2(b)) and assembly and recreation uses (Purpose Group 5) represent a greater life risk than other uses; and
- (d) that the building on the adjoining site has an identical elevation to the one in question, and is at the same distance from the common boundary; and
- (e) that no significant radiation will pass through any parts of the external wall that have fire resistance.

It may sometimes be advantageous to construct compartments of a smaller size than indicated by [Section 3](#), or to provide compartments where none would otherwise be necessary, in order to reduce the separation distance (or to increase the amount of unprotected area in the wall without increasing the separation distance).

4.4.2 Boundaries

The boundary which the wall of a building faces is called the relevant boundary (see [Diagram 65](#)). The relevant boundary may be one of the following:

- (a) the boundary of the site onto which the building is to be built; or
- (b) the centre line of a space where further development is unlikely, such as a road, railway, canal, river, or similar; or
- (c) a notional boundary, which is a theoretical division between two or more buildings occupying the same site, which are intended to be operated or occupied by the same organisation; or
- (d) a notional boundary, which is a theoretical division between opposing elevations of the same building, where the opposing elevations are divided into separate compartments.

The use of the distance to a boundary, rather than to another building, in measuring the separation distance makes it possible to calculate the allowable proportion of unprotected areas (see Paras 4.4.4 to 4.4.6), even where another building does not exist but may exist at some future point.

Where there are external attachments on the wall (see [Para 4.3.3](#)), the distance to the boundary should be measured from the wall.

Section 4: External Fire Spread

A wall of a building should be treated as facing a boundary if it makes an angle with it of 80° or less (see [Diagram 65](#)).

4.4.2.1 Notional Boundaries

The concept of a notional boundary between two buildings on the same site is illustrated in [Diagram 65](#).

The adequate separation distance between buildings on the same site should be calculated, where either of the following conditions apply:

- (a) The use of any building is residential (Purpose Groups 1(c), 2(a), 2(b)) or assembly and recreation (Purpose Group 5), whether a building is new or existing.
- (b) Where buildings are not residential, or assembly and recreation use, but occupy the same site and are intended to be occupied by different organisations.

Where buildings of the same purpose group occupy the same site, and are under the control of a single organisation, space separation between the buildings does not have to be considered, provided that the total floor area of all the buildings does not exceed the compartmentation requirements set out under [Table 15](#) for the specific building use (Purpose Group).

The notional boundary should be set in the area between two buildings on the same site, having regard to the following provisions:

- (i) The notional boundary is assumed to exist in the space between the buildings and is positioned so that one of the buildings would comply with the provisions for space separation, having regard to the amount of its unprotected area. In practice, if one of the buildings is existing, the position of the boundary will be set by the space separation factors for that building (see Dimensions X and Y in [Diagram 65](#)).
- (ii) The siting of the new building, or the second building, if both are new, can then be checked to see that it also complies, using the notional boundary as the relevant boundary for the second building.

Space separation between opposing elevations of the same building (see [Para 3.5.12](#)) may also need to be considered. The principles contained in this section are also relevant to these situations.

Section 4: External Fire Spread

Diagram 65 Relevant & Notional Boundary

Para 4.4.2

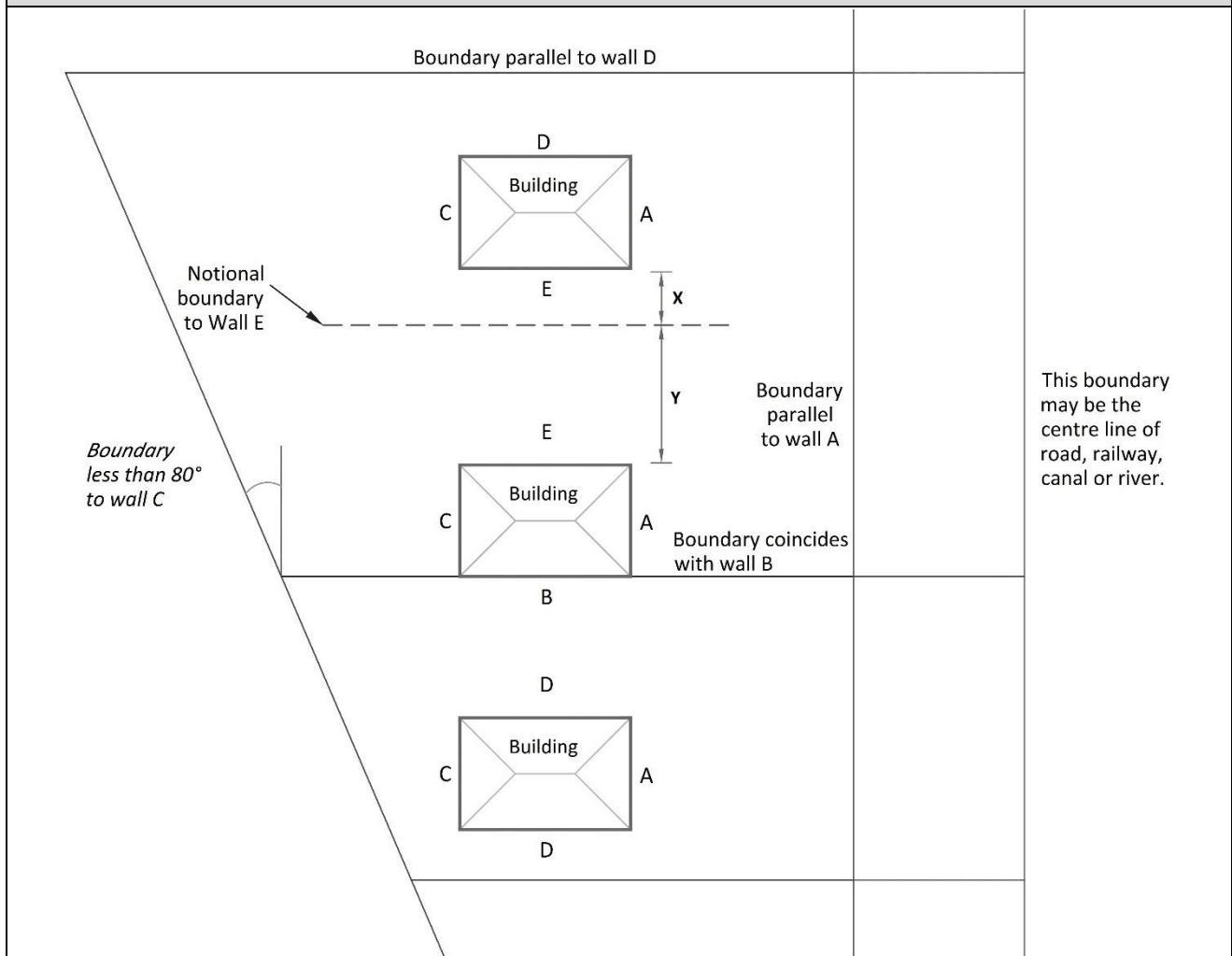

Notes:

- (1) For a boundary to be relevant it should:
 - (a) coincide with; or
 - (b) be parallel to, or;
 - (c) be at an angle of less than 80° to the external wall.
- (2) The notional boundary should be set in the area between the two buildings according to the following provisions:
 - (a) These provisions only apply when two or more buildings are on the same site and when one of the buildings (new or existing) is of residential or assembly use.
 - (b) A notional boundary should be set between a building of a use given in provision (a) and another building of any use.
 - (c) An existing building should be taken as if it were a new building of the same use but having the existing unprotected area and fire-resistance on the outside wall facing the notional boundary.
 - (d) The notional boundary should be so situated that all buildings comply with the provisions for space separation, having regard to the amount of unprotected areas.
 - (e) When set, the notional boundary becomes the relevant boundary.

Dimension X: Compliance with the provisions for space separation in respect of Building A (in accordance with [Para 4.4.4](#), [Para 4.4.5](#), and [Para 4.4.6](#))

Dimension Y: Compliance with the provisions for space separation in respect of Building B (in accordance with [Para 4.4.4](#), [Para 4.4.5](#), and [Para 4.4.6](#))

Section 4: External Fire Spread

4.4.3. Unprotected Areas and Fire Resistance

Any part of an external wall which has less fire resistance than the appropriate amount indicated in [Table 31](#), item 6 and [Table 32](#) of [Appendix A](#) is considered to be an unprotected area.

4.4.3.1 Outermost Wall Elements Contributing to Unprotected Areas

Where a building has a wall with the appropriate fire resistance, with an external surface material that does not achieve a reaction to fire classification of Class A – s3, d2, then half that part of the wall should be classified as unprotected area (see [Diagram 66](#)).

Where a building has a wall with the appropriate fire resistance, but where a material that does not achieve a reaction to fire classification of Class A – s3, d2 is fixed on the external wall of the building (such as a solar panel, etc.), then half the area of the element should be taken as unprotected area (see [Diagram 66](#)).

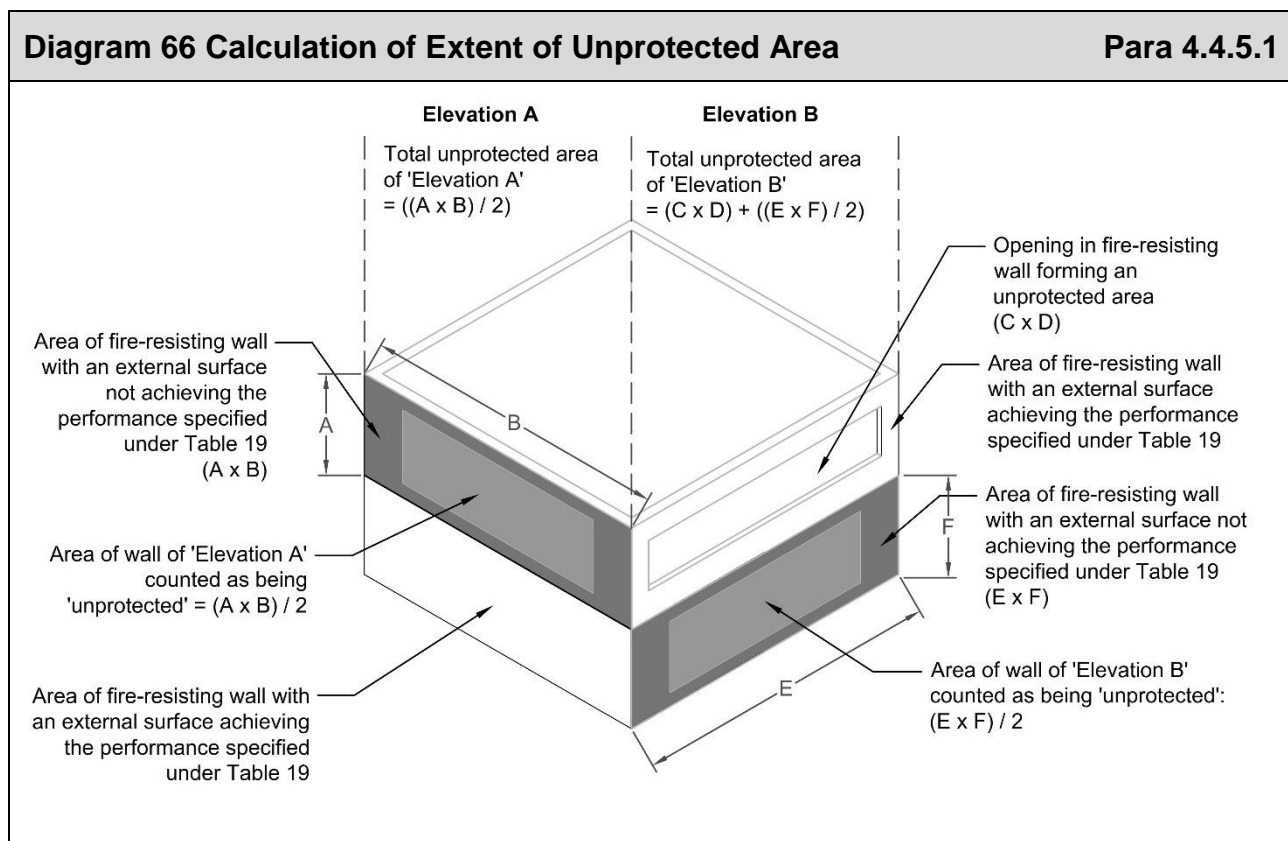

Section 4: External Fire Spread

4.4.4 External Walls within 0.5 m of a Boundary

A wall situated within 0.5m of the boundary should have no unprotected area, other than any wall-head fascia, soffit or barge board, or any cavity vents or solem vents.

4.4.5 External Walls between 0.5 m and 1 m of the Relevant Boundary

A wall situated within 1m from any point on the relevant boundary will meet the provisions for space separation if:

- (a) The only unprotected areas conform to (i), (ii), or (iii) below, and clause (b) (see [Diagram 67](#)):
 - (i) for unprotected areas of $\leq 0.1 \text{ m}^2$, such areas are separated from any other such unprotected area of $\leq 0.1 \text{ m}^2$ by a distance of $\geq 1.5 \text{ m}$, including where the areas are separated by a compartment wall or floor; or
 - (ii) for unprotected areas of $\leq 1.0 \text{ m}^2$, or a group of unprotected areas within an area of $1.0 \text{ m} \times 1.0 \text{ m}$, such areas are separated from any other such unprotected area of $\leq 1 \text{ m}^2$ by a distance of $\geq 4.0 \text{ m}$. Where the areas are separated by a compartment wall or floor this distance may be reduced to $\geq 1.5 \text{ m}$; or
 - (iii) an unprotected area as at (i) above may be separated from an unprotected area as at (ii) above by a distance of $\geq 1.5 \text{ m}$.
- (b) The rest of the wall is fire resisting from both sides.

The wall should comply with the provisions of [Table 19](#).

4.4.6 External Walls 1 m or More from the Relevant Boundary

A wall situated at least 1 m from any point on the relevant boundary will meet the provisions for space separation if:

- (a) the extent of unprotected area does not exceed that given by one of the methods referred to in [Para 4.4.6.1](#) below; and
- (b) the rest of the wall (if any) is fire resisting from the inside.

Diagram 67 Unprotected Areas Which may be Disregarded for Space-Separation Purposes

Para 4.4.5

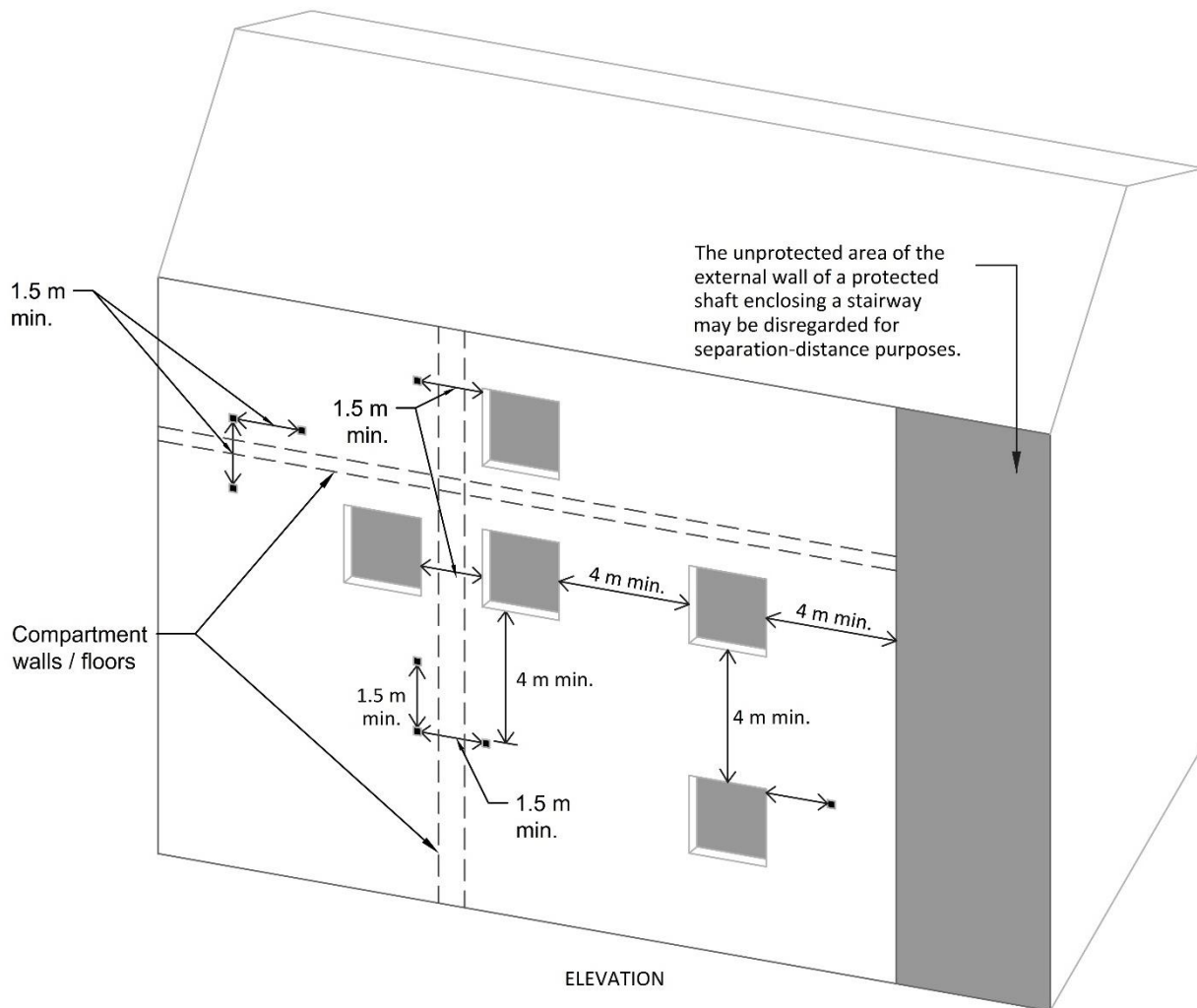



ELEVATION



PLAN

KEY

-  Unprotected area of 1.0m² maximum; or group of unprotected areas within an area of 1m x 1m.
-  Unprotected area of 0.1m² maximum.

Notes:

- (1) The unprotected area of the enclosure to a protected stairway may be disregarded for the purpose of space separation.
- (2) There are restrictions in Section 1 (see [Para 1.5.6.6](#) and [Diagram 15](#)) on the unprotected areas of external enclosures to a building adjacent to any unprotected area in the enclosure to a protected stairway.
- (3) There are also restrictions in Section 1 (see [Para 1.5.9](#) and [Diagram 17](#)) on unprotected areas adjacent to external escape stairways.
- (4) Dimensions shown are minimum separation distances between unprotected areas of elevation.
- (5) External walls are required to be fire resisting from each side

Section 4: External Fire Spread

4.4.6.1 Methods for Calculating Acceptable Unprotected Area

Two methods are given in this document for calculating the acceptable amount of unprotected area in an external wall that is at least 1 m from any point on the relevant boundary (For walls within 1m of the boundary, see [Para 4.4.4](#) and [Para 4.4.5](#) above).

Method 1 (See [Para 4.4.6.2](#)) is only suitable for small residential buildings which do not belong to Purpose Group 2(a): Residential (care facility).

Method 2 (see [Para 4.4.6.3](#)) may be used for buildings or compartments for which Method 1 is not appropriate.

For the buildings outlined above, either Methods 1 or 2 as appropriate, or the enclosing rectangle (geometric) method, or protractor method specified in BR 187 External Fire Spread: Building Separation and Boundary Distances may be used.

For buildings or compartments not meeting the criteria as specified in Methods 1 or 2 (including buildings higher than 10 m or compartments more than 10 m in height,) the enclosing rectangle (geometric) method specified in BR 187 External Fire Spread: Building Separation and Boundary Distances should be used.

For buildings or compartments which are fitted throughout with an appropriate automatic sprinkler system (see [Section 8](#)), the values in columns (a) or (b) of [Table 21](#) may be halved. Similarly, where BR 187 is used, the provisions of Para 2.1.7 of that document are appropriate where buildings or compartments are fitted throughout with an appropriate automatic sprinkler system (see [Section 8](#)).

4.4.6.2 Method 1 - Small Residential Buildings

This method applies only to a building containing flats (Purpose Group 1(c)) or residential (other) building (Purpose Group 2(b)) which is not less than 1 m from any point on the relevant boundary.

The following rules for determining the maximum permitted unprotected area should be read with [Diagram 68](#) and [Table 20](#):

- (a) The building should not exceed 3 storeys in height (basements not counted) or be more than 24 m in length.
- (b) Each side of the building will meet the provisions for space separation if
 - (i) the distance of the side of the building from the relevant boundary, and
 - (ii) the extent of unprotected area, are within the limits given in [Table 20](#).
- (c) Any parts of the side of the building in excess of the maximum permitted unprotected area should be fire resisting.
- (d) In calculating the maximum permitted unprotected area, any unprotected areas meeting the size and separation-distance requirements shown in [Diagram 67](#) can be disregarded.

Section 4: External Fire Spread

Table 20 Permitted Unprotected Areas in Small Residential Buildings		Para 4.4.6.2
Minimum distance (A) between side of building and relevant boundary (m)		Maximum total area of unprotected areas (m ²)
1.0		5.6
2.0		12.0
3.0		18.0
4.0		24.0
5.0		30.0
6.0		no limit

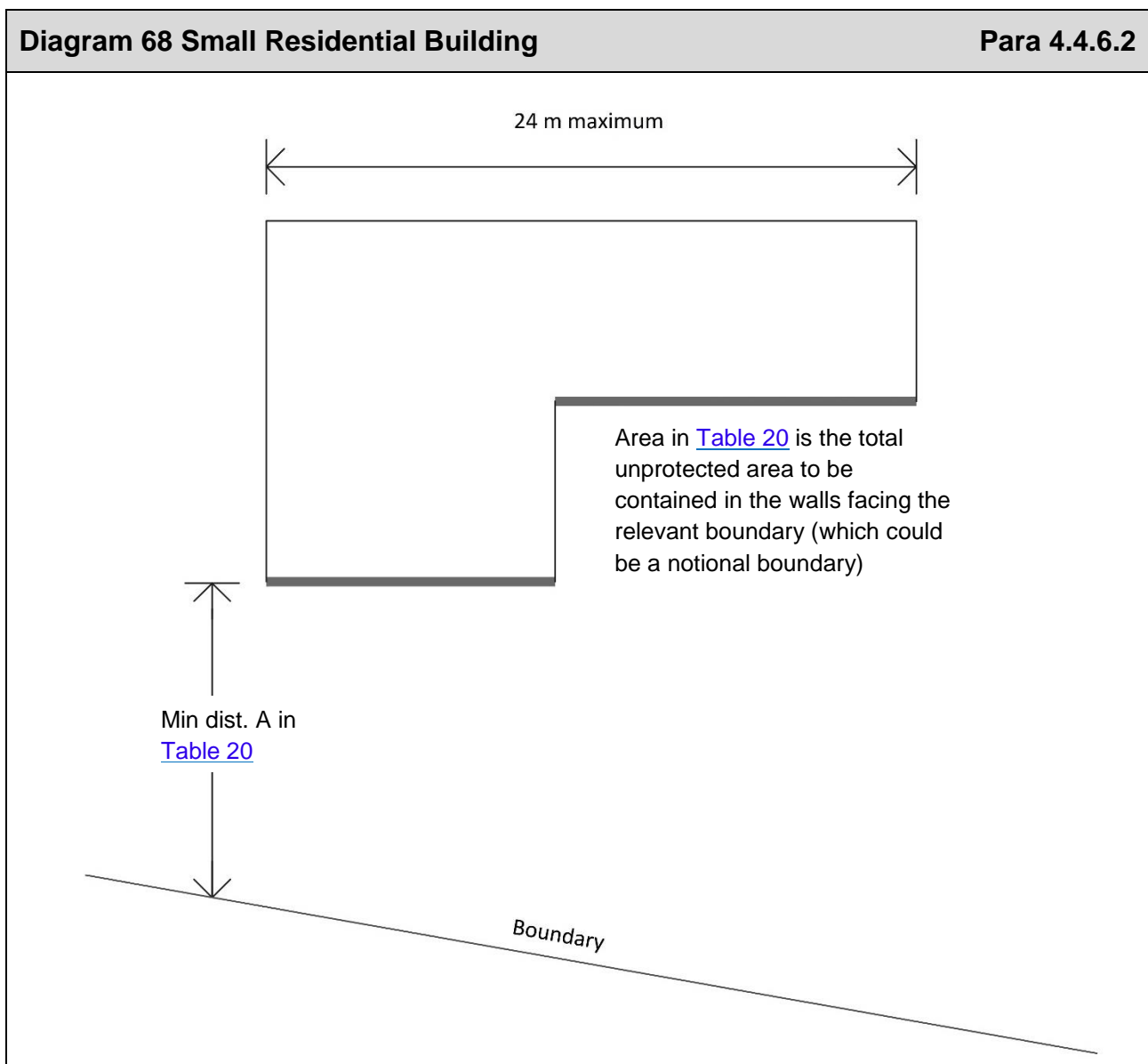

Section 4: External Fire Spread

Table 21 Permitted Unprotected Areas in Other Buildings or Compartments Para 4.4.6.3		
Minimum distance between side of building and relevant boundary (m)		Maximum unprotected area as a percentage of total wall area (%) of building or compartment
Purpose Group		
Column (a)	Column (b)	
Residential, office, assembly and recreation (Purpose Groups 1(c), 2(a), 2(b), 3 and 5, 6(a) and 7(a))	Shop, shopping centre, industrial, storage & other non-residential (Purpose Group 4, 4(a), 6(b), 7(b) and 8)	
0	0	0
2.5	5	20
5.0	10	40
7.5	15	60
10.0	20	80
12.5	25	100

Notes:

- (1) Intermediate values may be obtained by interpolation.
- (2) For buildings or compartments which are fitted throughout with an appropriate automatic sprinkler system (see [Section 8](#)), the values in columns (a) or (b) may be halved.
- (3) In the case of open-sided car parks in Purpose Group 7(c), the distances set out in Column (a) maybe used instead of those in Column (b).

4.4.6.3 Method 2 - Other Buildings or Compartments

This method applies to a building or compartment intended for any use and not less than 1 m from any point on the relevant boundary. The following rules for determining the maximum permitted unprotected area should be read with [Table 21](#).

- (a) The building height (see [Diagram 90](#)) or the height of each individual compartment within a building should not exceed 10m in height, except for open-sided car parks in Purpose Group 7(c).
- (b) Each side of the building will meet the provisions for space separation if:
 - (i) the distance of the side of the building from the relevant boundary, and
 - (ii) the extent of unprotected area are within the percentage limits of unprotected area specified in [Table 21](#).

In calculating the maximum permitted unprotected area, any unprotected areas meeting the size and separation-distance requirements shown in [Diagram 67](#) can be disregarded.

Any parts of the side of the building in excess of the maximum permitted unprotected area should be fire resisting from the inside.

Section 4: External Fire Spread

4.4.7 Buildings Containing Atria

In the case of a building containing one or more atria (see [Diagram 69](#)):

- (a) where the building is not provided with a sprinkler system throughout, the method for calculating acceptable unprotected area needs to be on the basis that all storeys not separated from the atrium by a minimum of 30 min fire-resisting construction could be involved in the fire (The elevation should be regarded as single compartment for the purpose of calculating the distance to the boundary); or
- (b) where the building is provided with a sprinkler system throughout, (see [Section 8](#)) the method for calculating acceptable unprotected area should be on the basis that all storeys are separated by compartment floors.

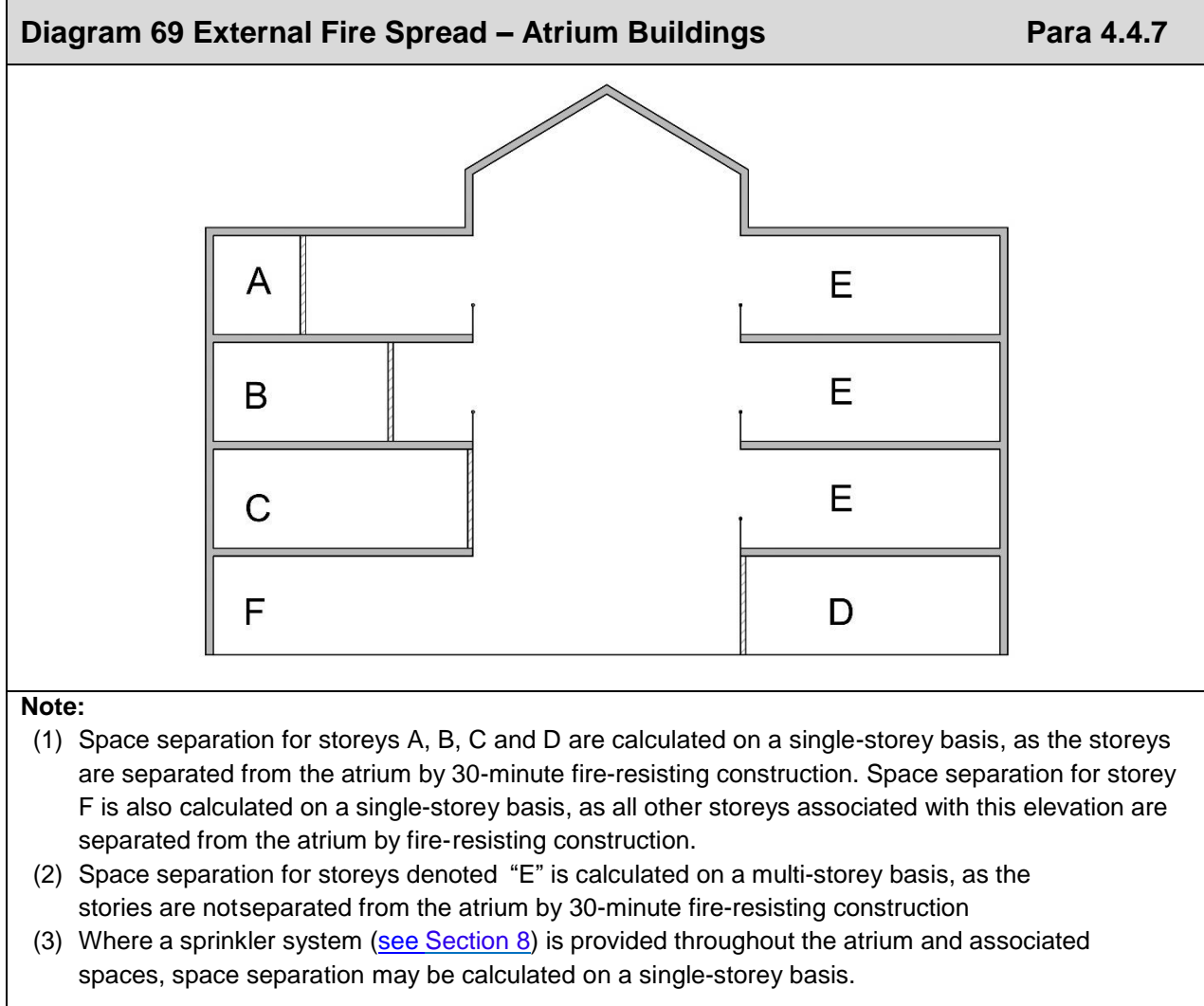

Section 4: External Fire Spread

4.5 Roof Coverings

4.5.1 Introduction

The provisions in this subsection limit the proximity to the boundary of those types of roof covering which will not give adequate protection against the spread of fire.

4.5.2 Other Controls on Roofs

There are provisions concerning the fire properties of roofs elsewhere. In Section 3, there are provisions in [Subsection 3.5](#) for roofs that pass over the top of a compartment wall or separating wall. In [Subsection 2.3](#), there are provisions for the internal surfaces of roof lights as part of the internal lining of a room or circulation space.

4.5.3 Classification of Performance

The performance of roof coverings is determined in accordance with I.S. EN 13501-5. The notional performance of some common roof coverings is given in [Table 35](#) of [Appendix A](#).

Rooflights are controlled on a similar basis, although there is a different method of classification for plastic rooflights.

4.5.4 Separation Distances

The separation distance is the minimum distance from the roof (or part of the roof) in question to the nearest boundary, which may be a notional boundary.

[Table 22](#) sets out separation distances according to the type of roof covering and the size and use of the building. However, there are no restrictions on the use of roof coverings designated class B_{ROOF}(t4)

In addition, roof covering products (and/or materials) as defined in Commission Decision 2000/553/EC of 6th September 2000 implementing Council Directive 89/106/EEC as regards the external fire performance of roof coverings can be considered to fulfil all of the requirements for performance characteristic “external fire performance” without the need for testing, provided that any national provisions on the design and execution of works are fulfilled. That is, the roof covering products (and/or materials) defined in this Commission Decision can be used without restriction.

4.5.5 Plastic Rooflights

[Table 23](#) sets out the limitations on the use of plastic rooflights (see also [Diagram 70](#)) which do not meet the basic provisions described in [Table 22](#) but which have a lower surface of thermoplastic material with a TP (a) rigid or TP(b) classification (see [A8](#) of [Appendix A](#)).

When used in rooflights, a rigid thermoplastic sheet product, which is made from polycarbonate or from unplasticised PVC and which achieves a Class C–s3, d2 can be regarded as having B_{ROOF}(t4).

Section 4: External Fire Spread

4.5.6 Glass in Rooflights

When used in rooflights, unwired glass at least 4mm thick can be regarded as having B_{ROOF}(t4) designation. Thinner glass should only be used where the separation distance is 6 m or more.

4.5.7 Solar Panels on Roofs

When a solar panel is placed on a roof, the roof beneath the panel, and the area of roof within 1m of the panel, measured in line with the pitch of the roof, should achieve a Class B_{ROOF}(t4) designation, irrespective of the distance to the relevant boundary.

Table 22 Limitations on Roof Coverings*				
Reaction-to-fire classification	Minimum distance from any point on relevant boundary ⁽³⁾			
	< 6 m	≥ 6 m	≥ 12 m	≥ 20 m
B _{ROOF} (t4)	✓	✓	✓	✓
C _{ROOF} (t4)	x	✓	✓	✓
D _{ROOF} (t4)	x	✓(1)	✓(2)	✓
E _{ROOF} (t4)	x	✓(1)	✓(2)	✓(2)
F _{ROOF} (t4)	x	x	x	✓(1)

Notes:

* See Para 4.5.6 for limitation on glass, and [Table 23](#) for limitation on plastic rooflights.

✓ Acceptable

X Not acceptable

(1) Not acceptable on any building listed below:

- industrial, storage or other non-residential purpose group buildings of any size; and
- any other buildings with a cubic capacity of more than 1500 m³,
- only acceptable on other buildings if the part of the roof is no more than 3 m² in area and is at least 1.5 m from any similar part, with the roof between the parts covered with a material with a reaction-to-fire classification achieving Class A2-s3, d2, or better.

(2) Not acceptable on any of the buildings listed at (a), or (b) in (1) above.

(3) Roof at a pitch greater than 70° to the horizontal should comply with this table

Section 4: External Fire Spread

Table 23 Limitations on Plastic Rooflights		Para 4.5.5		
Classification on lower surface ⁽¹⁾	Space which rooflights can serve:	Minimum distance from any point on relevant boundary to a rooflight with an external surface classification ⁽²⁾ of:		
		TP(a)	TP(b)	F _{ROOF} (t ₄)
TP(a) rigid	any space except a protected stairway	6 m	6 m ⁽⁴⁾	20 m
TP(b)	any circulation space ⁽³⁾ (except a protected stairway)	6 m ⁽⁴⁾	6 m ⁽⁴⁾	20 m ⁽⁴⁾

Notes:

- (1) See also the guidance in [Section 2](#).
- (2) The classification of external roof surfaces is explained in [Appendix A](#).
- (3) Single-skin rooflights only, in the case of non-thermoplastic material.
- (4) The rooflights should also meet the provisions of [Diagram 70](#).

None of the above designations are suitable for protected stairways - (see [Para 2.3.2](#)). Products may have upper and lower surfaces with different properties if they have double skins or are laminates of different materials.

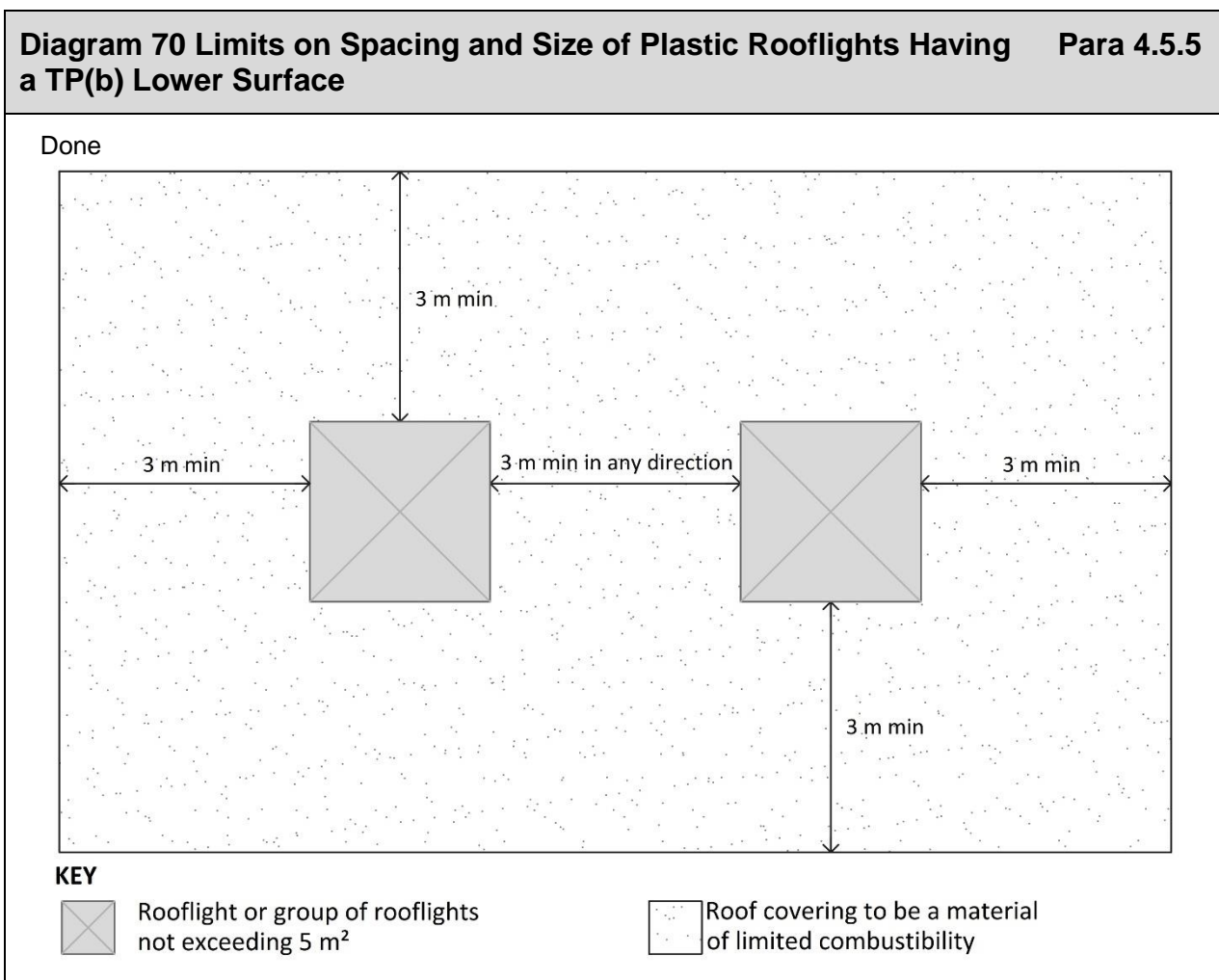

Section 5 Access and Facilities for the Fire Service

5.1 General

The guidance in this section shows compliance with Part B of the Second Schedule to the Building Regulations, in particular Regulation B5. However access and facilities for the fire service are also aided by the provisions outlined in [Section 1](#), [Section 3](#) and [Section 6](#).

These requirements may be achieved, to an extent dependant on the use and size of the building if:

- (a) there is sufficient means of external access to enable fire appliances to be brought near enough to the building for effective use; and
- (b) there is sufficient means of access into, and within, the building for firefighting personnel to effect rescue and fight fire; and
- (c) the building is provided with sufficient fire mains and other facilities to assist firefighters in their tasks.

5.2 Introduction to Provisions

This section provides for the provision of access and facilities for the fire service within and around buildings for the purpose of facilitating firefighting to protect life.

The requirements of the Building Regulations relate primarily to a building, and the site it is contained on, but do not extend beyond the curtilage of the site.

Adequacy of public access roads to enable fire appliances to get to the site, as distinct to onto or around the site, and adequacy of public water supplies for firefighting purposes, cannot be dealt with under the Building Regulations. These have to be dealt with under other legislation.

To assist the fire service, some or all of the following facilities may be necessary, depending mainly on the size of the building:

- fire mains around and within buildings, including the provision of hydrants (see [Subsection 5.3](#));
- vehicle access to the building (on a site) for fire appliances (see [Subsection 5.4](#));
- access to and within the building for firefighting personnel (see [Subsection 5.5](#));
- other facilities such as electrical isolation switches and foam inlets to basement boiler-houses or fuel storage spaces (see [Subsection 5.6](#)); and
- provisions for venting of heat and smoke from basement areas and other spaces (see [Section 6](#)).

Section 5: Access and Facilities for the Fire Service

5.3 Fire Mains

5.3.1 Introduction

Fire mains are pipes installed in and around a building, and equipped so that the fire service may connect hoses to receive a supply of water to fight fires. Fire mains are divided into two types as follows

- internal fire mains (see [Para 5.3.2](#)), and
- external fire mains and hydrants (see [Para 5.3.3](#)).

5.3.2 Internal Fire Mains

Internal fire mains should be provided in any of the following situations:

- (a) In a building with a topmost floor at more than 11 m and less than 20 m (in a protected stairway) of a building containing flats; Residential (care facility), Residential (other), or Shopping Centre building (Purpose Groups 1(c), 2(a), 2(b), or 4(b)) (see [Para 5.5.4](#)).
- (b) In a firefighting shaft in buildings with a floor at more than 20 m above ground level (in the lobby to the firefighting shaft) (see [Para 5.5.5](#)).
- (c) In basements at not more than 10 m below ground, with two or more floors with a floor area > 900 m² per floor (in a protected stairway) (see [Para 5.5.2.2](#)).
- (d) In a firefighting shaft in buildings with a basement at more than 10m below ground level (in the lobby to the firefighting shaft), (see [Para 5.5.2.3](#)).

5.3.2.1 Types of Internal Mains

Internal fire mains may be of two types:

- rising mains, serving floors above ground or access level; or
- falling mains, serving levels below ground or access level.

These internal fire mains may be of two types:

- the "dry" type, normally empty and supplied through hose from a fire-service pumping appliance, or
- the "wet" type, kept full of water and supplied from tanks and pumps in the building.

In any building with a topmost floor level up to 50 m above ground level, the internal main should be of the "dry type".

In any building with any floor at more than 50 m above ground level, the internal main should be of the "wet" type.

5.3.2.2 Outlets to Fire Mains

Where an internal main is installed, there should be an outlet at each floor level. These fire mains should be located in:

- (a) a protected stairway; or
- (b) a common access balcony or walkway in the open air; or
- (c) the lobby to a firefighting shaft.

5.3.2.3 Design and Construction of Internal Fire Mains

The design and construction of internal fire mains should be in accordance with the relevant sections of I.S. 391.

5.3.3 External Fire Mains and Hydrants

Most urban areas are supplied with water through public water mains. Where such mains are provided, it is normal to have hydrants provided for the fire brigade to obtain a ready supply of water for firefighting.

The siting of these hydrants is important with regard to both accessibility for fire brigade use and proximity to buildings for quick and effective firefighting.

The provision of water mains, and suitably located hydrants, outside of the site of a building does not come within the scope of the Building Regulations.

In many cases, especially for smaller developments in urban areas, hydrants on public water mains will be adequate.

However, for larger buildings, requiring a greater number of hydrants, additional hydrants on a private main may be required.

Where public water mains are not available, the provision of external fire mains and hydrants is not required, but the provision of an alternative source of water is necessary.

5.3.3.1 External Fire Mains

In any given case the necessity of a fire main is dependent on:

- (a) the number of hydrants required for the building; and
- (b) the need for the hydrants to be distributed around the building, having regard to the requirements for perimeter access; and
- (c) the availability of hydrants on public mains and their proximity to the building.

Where fire mains are provided, they should be designed in accordance with I.S. 391.

Section 5: Access and Facilities for the Fire Service

5.3.3.2 Number and Location of Hydrants

The number of external fire hydrants for a building should be provided in accordance with [Para 5.3.3.2.1](#) or [Para 5.3.3.2.2](#). Such hydrants should be located in accordance with [Para 5.3.3.2.3](#).

The number of hydrants required may be made up by a combination of public hydrants and private hydrants.

5.3.3.2.1 Buildings without an Internal Fire Main

For buildings without an internal fire main, where a public water main is available, the following requirements apply:

- A hydrant should be provided where the building has a floor area, on any storey, of more than 1000 m²; and
- For a building exceeding 1000 m², at least one hydrant should be provided for every 1000 m² of area of the largest storey.

For a building, exceeding 1000 m², where no public water main is available, an adequate alternative water source should be provided, as follows:

- (a) a static water tank; or,
- (b) an inexhaustible open source, such as a river, canal, lake or pond; or
- (c) an equivalent alternative source.

The volume of water required should be calculated on the basis of:

- the use of the building,
- the size of the largest compartment in the building, and
- the availability of a suppression system,

but it should be no less than 45,000 litres.

5.3.3.2.2 Buildings with an Internal Fire Main

For buildings provided with internal fire mains (wet or dry), at least one fire hydrant should be provided.

Section 5: Access and Facilities for the Fire Service

5.3.3.2.3 Location of Hydrants

For public hydrants to be considered, they should be located within 46 m of the building.

Where private hydrants are provided, they should be located as shown in [Diagram 71](#) and such that:

- (a) a hydrant should be no less than 6 m and not more than 46 m from the building; and
- (b) the distance from a hydrant to a vehicle access roadway or hard-standing area for fire appliances (see [Subsection 5.4](#)) should not be more than 30 m; and
- (c) hydrants should be distributed around the perimeter of the building, having regard to the provision of access for fire appliances (see [Subsection 5.4](#)); and
- (d) hydrants should be located on the same site as the building; and
- (e) private hydrants should be conspicuously marked in accordance with BS 3251.

For buildings fitted with an internal fire main (wet or dry), the location of the hydrant should conform to [Para 5.4.3](#).

Diagram 71 External Fire Mains and Hydrants

Para 5.3.3.2.3

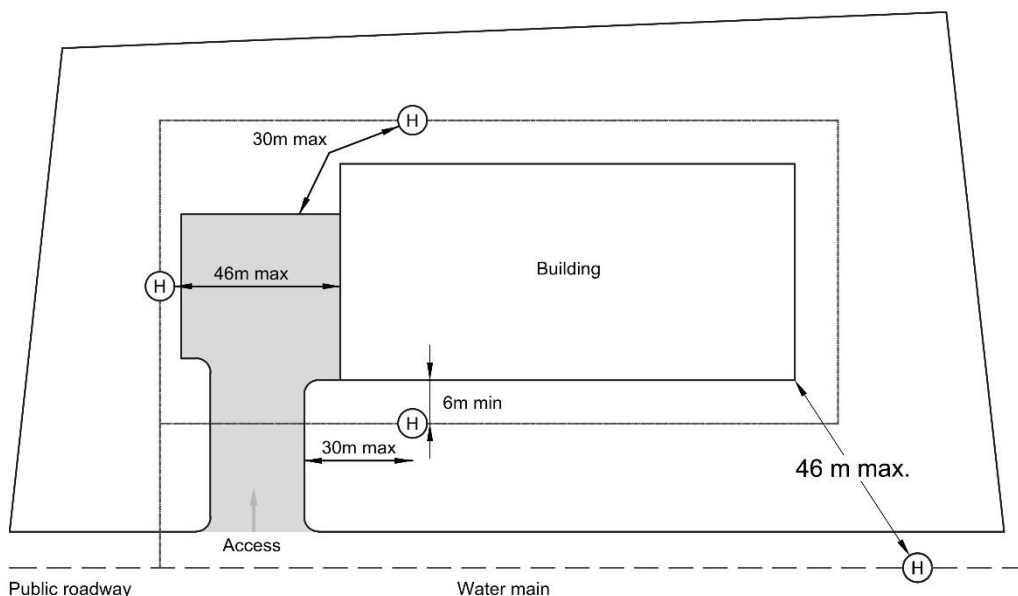

- KEY
- Water main (public)
 - Fire main
 - ⊕ Hydrant
 - Hardstanding

(a) Building with no internal fire main

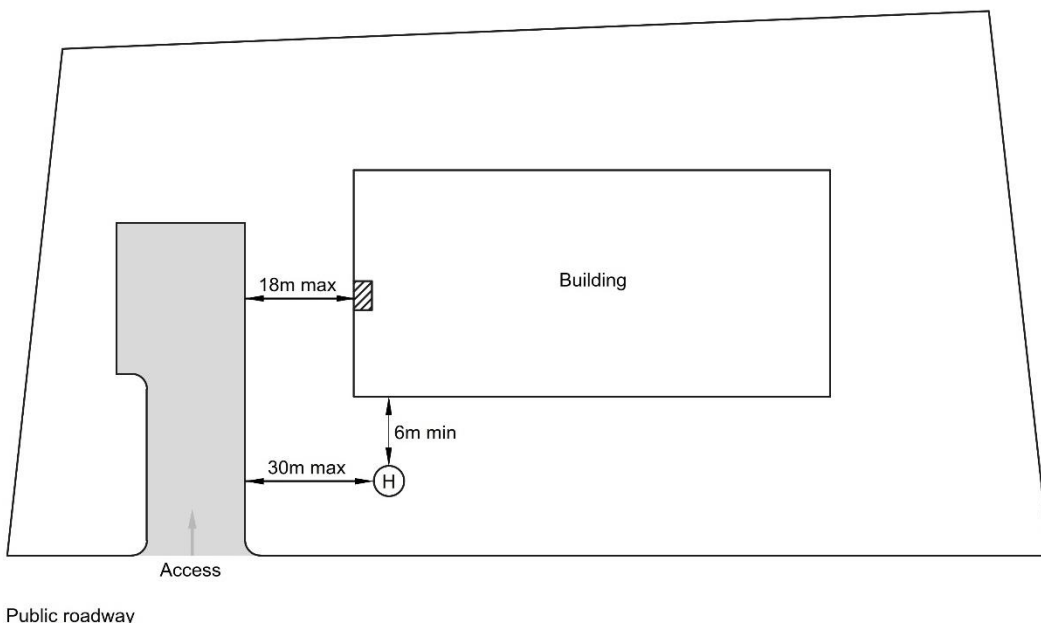

- KEY
- ▨ Dry Riser Inlet
 - ⊕ Hydrant
 - Hardstanding

(b) Building with an internal fire main

Notes:

- (1) Refer to [Para 5.3.3](#) for external mains.
- (2) Refer to [Para 5.3.3.2](#) for provision of hydrants.
- (3) Refer to [Subsection 5.4](#) for provision of vehicle access.

Section 5: Access and Facilities for the Fire Service

5.4 Vehicle Access

5.4.1 Introduction

Fire brigade vehicle access to the exterior of a building is required to enable firefighting operations.

In any particular case the type of vehicle access is dependent on whether or not the building is provided with internal means of firefighting, e.g. a firefighting shaft or an enhanced stairway with fire main.

For buildings not fitted with an internal fire main, vehicular access should be provided in accordance with the provisions of [Para 5.4.2](#).

For buildings fitted with an internal fire main (see [Para 5.3.2](#)), vehicular access should be provided in accordance with the provisions of [Para 5.4.3](#).

Vehicle access routes and hardstandings should meet the criteria described in [Para 5.4.4](#).

Minimum performance for the purposes of fire service access on roads within the site boundary, are set out in this subsection. Adequacy of public access roads to enable fire appliances to get to the site is outside the scope of the Building Regulations and has to be dealt with by other legislation.

In the provision of access for fire appliances, consideration should also be given to the position of any hydrants required by reason of the criteria outlined in [Subsection 5.3](#).

5.4.2 Buildings not Fitted with an Internal Fire Main

For buildings not fitted with an internal fire main, fire brigade vehicle access to the exterior of a building is required to enable pumping appliances to supply water and equipment for firefighting and, depending on the height of the building, to enable high-reach appliances, such as turntable ladders and hydraulic platforms, to be deployed.

Vehicle access should be provided in accordance with the criteria indicated in [Table 24](#). Any elevation to which vehicle access is provided in accordance with [Table 24](#) should contain a door giving access to the interior of the building.

In the case of a building which has adjoining buildings on one or more sides, the perimeter (see [Subsection 0.10](#) for the definition, and [Diagram 72](#) for the measurement of “perimeter”) which is available to provide access is less than that for a free-standing building.

Section 5: Access and Facilities for the Fire Service

Diagram 72 Building Perimeter

Para 5.4.2

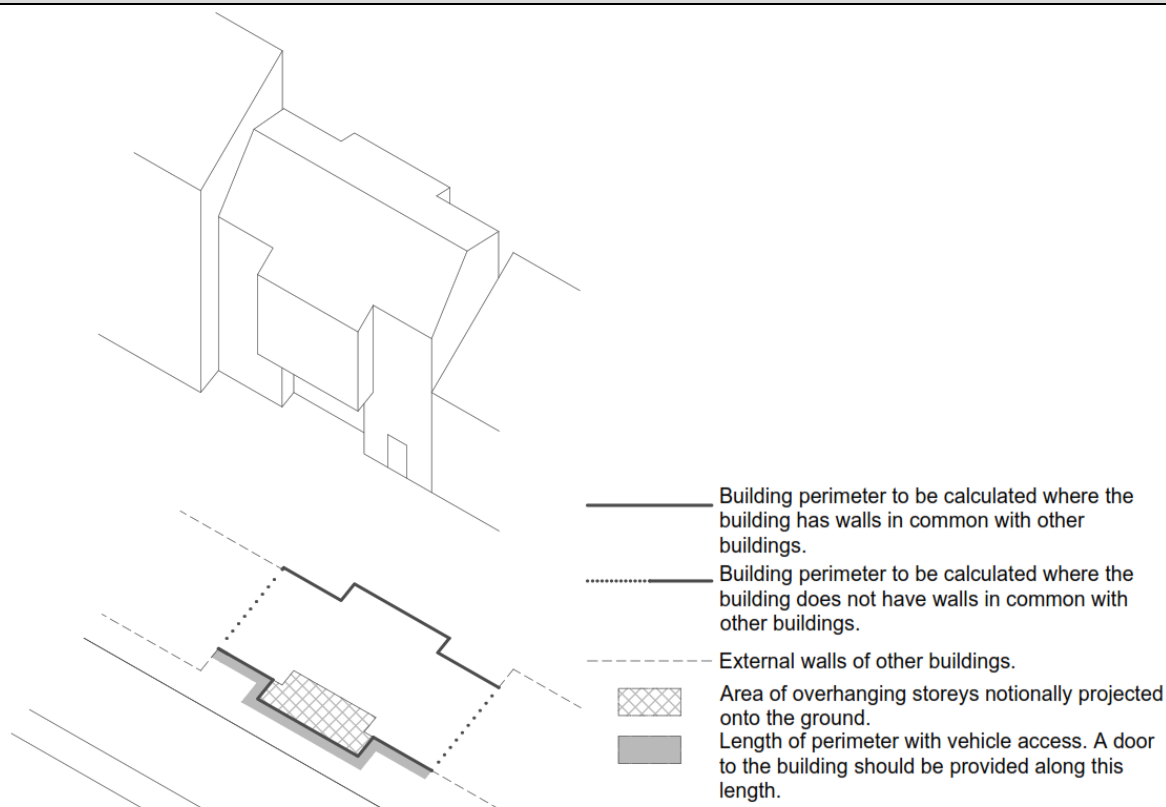

Notes:

- (1) The total footprint of the building is the maximum aggregate plan perimeter found when all overhanging storeys are notionally projected onto the ground.
- (2) Where a building has any external wall in common with another building, the portion of common wall is not required to be included in perimeter calculations.
- (3) Portions of a perimeter which are not common to buildings are included in perimeter calculations, regardless of access to a road.
- (4) The length of perimeter provided with vehicle access should be equal to, or greater than that required under [Table 24](#)

Table 24 Vehicle Access to Buildings with a Topmost Floor up to 20 m

Para 5.4.2

Volume of building (m ³)	Height of top storey above ground (m)	Provide vehicle access	Type of appliance
up to 7,000	up to 11	at a rate of 2.4 m in length for every 90 m ² of ground floor area	pump
	over 11	to 15% of perimeter	high reach
7,000-28,000	up to 11	to 15% of perimeter	pump
	over 11	to 50% of perimeter	high reach
28,000-56,000	up to 11	to 50% of perimeter	pump
	over 11	to 50% of perimeter	high reach
56,000-85,000	up to 11	to 75% of perimeter	pump
	over 11	to 75% of perimeter	high reach
over 85,000	up to 11	to 100% of perimeter	pump
	over 11	to 100% of perimeter	high reach

5.4.2.1 Buildings That Cannot Achieve Table 25

For buildings, where there are adjoining buildings on one or more sides, the access requirement derived from [Table 24](#) may not be achievable.

For such buildings with more than one storey, where it is proven that required perimeter access cannot be achieved, in addition to the maximum available perimeter access, additional facilities for internal firefighter access should be provided.

The additional facilities that should be provided are a minimum of 1 enhanced protected stairway (a protected stairway with enhanced protection, and facilities for firefighting) which consists of

- (a) 60-minute fire-resistance (REI, each side separately); and
- (b) an internal fire main, which is provided within the stairway (see [Para 5.3.2](#)).

Access to the fire main inlet should conform to [Para 5.4.3](#).

For such buildings with a floor area of greater than 900 m², there should be a minimum of 2 such protected stairways. This provision does not apply to a building containing flats.

All points on the floor should be no more than 45 m from the entrance door to the stairway containing the fire main, measured on a route suitable for laying hose. Where the building is fitted throughout with an automatic sprinkler system (see [Section 8](#)), the maximum hose distance can be increased from 45 m to 60 m.

If the internal layout is unknown at the design stage, then every part of every such storey should be no more than two-thirds of the required distance.

5.4.3 Buildings Fitted with Fire Mains

In the case of a building fitted with a dry internal fire main (see [Para 5.3.2](#)), access for a pump appliance should be provided to within 18 m, and within sight of the inlet connection point. Inlets should be on the face of the building, and should be located in accordance with I.S. 391. A hydrant should also be within 30 m of the access point for the pumping appliance.

In the case of a building fitted with a wet internal fire main, access for a pump appliance should be provided to within 18 m, and within sight of an entrance giving access to the main, and within sight of the inlet connection to the suction tank for the main.

5.4.4 Design of Access Routes and Hardstandings

A vehicle access route may be a public or private road, or other route. Public and private roads may be used for the consideration of access to a building's perimeter (see [Para 5.4.2](#)). However, the design and specification of public roads do not come within the scope of the Building Regulations.

Section 5: Access and Facilities for the Fire Service

Table 25 Vehicle Access Route Specifications		
	Appliance type	
	Pump	High Reach
Minimum width of road between kerbs (m)	3.7	3.7
Minimum width of gateways between kerbs (m)	3.1	3.1
Minimum turning circle between kerbs (m)	16.8	26.0
Minimum turning circle between walls (m)	19.2	29.0
Minimum clearance height (m)	3.7	4.0
Minimum carrying capacity (tonnes)	12.5	16.25

5.4.4.1 Access Routes on Private / Site Roads

Where private roads / site roads which include any manhole or other covers are provided, they should meet the provisions set out in [Table 25](#), and the following paragraphs.

Where vehicle access is provided on a podium, or above any basement, or similar supported structure, the provisions of [Table 25](#) should be met. Fire authorities use different sized appliances and for such buildings, it is advisable that the relevant fire authority be consulted.

Where access to an elevation is provided in accordance with [Table 24](#), the pump or high-reach-appliance access should be provided adjacent to the building for the specified percentage of the total perimeter. Overhead obstructions such as overhead cables that would interfere with the setting of ladders, etc., should be avoided in the area shown on [Diagram 73](#).

Where access roadways are provided within the site of a building, turning facilities for appliances, in accordance with the requirements of [Table 25](#), should be provided in any dead-end access route that is more than 20 m long.

Further guidance on the provision of turning facilities is provided in Section 2.6 of the Recommendations for Site Development Works for Housing Areas.

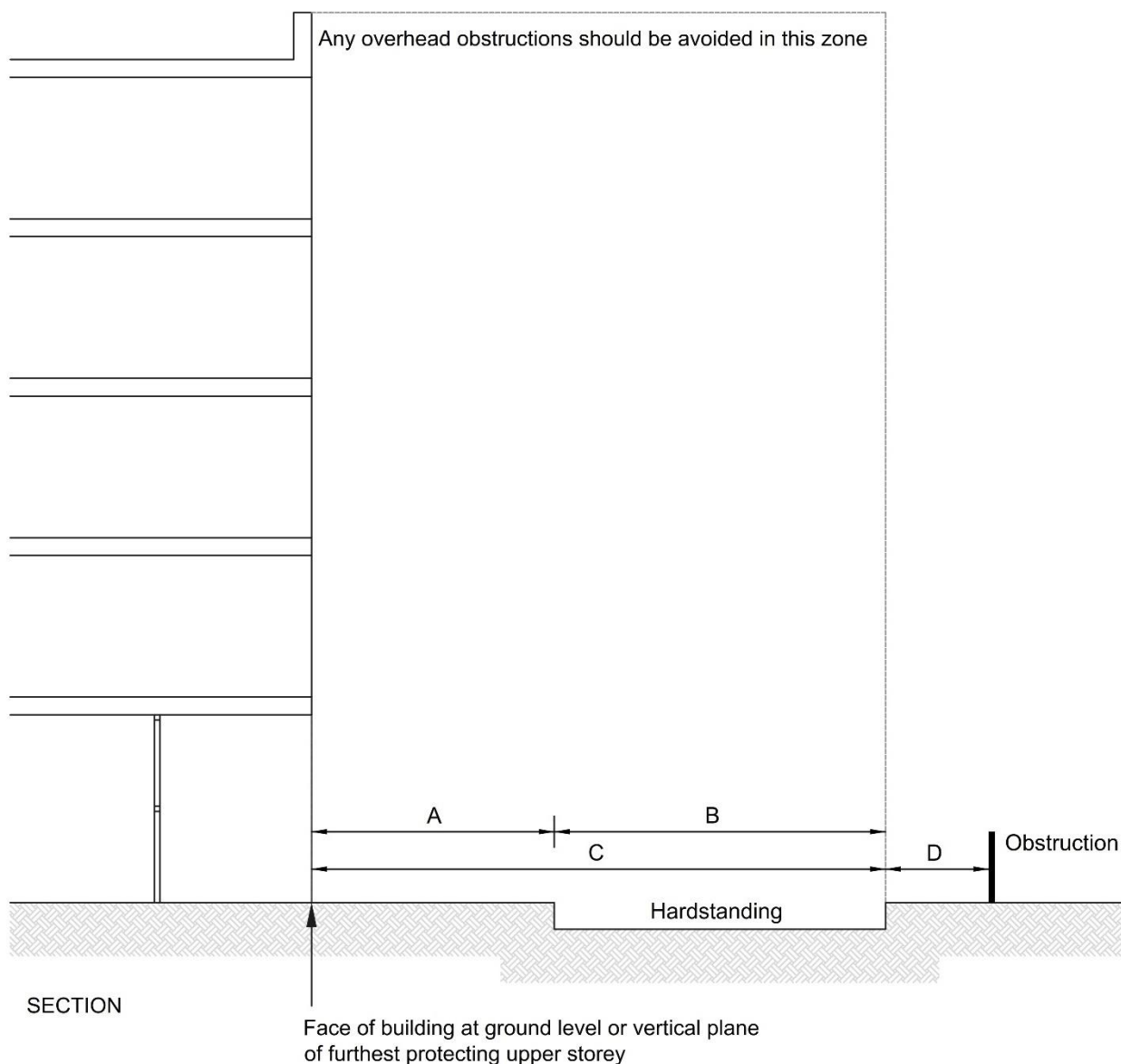

Dimension	Type of Appliance	
	Hydraulic platform	Turntable ladder
A: Maximum distance of hardstanding from building	2.0 m	4.9 m
B: Minimum width of hardstanding	5.5 m	5.0 m
C: Minimum distance of further edge of hardstanding	7.5 m	10 m
D: Minimum width of unobstructed space for swing of hydraulic platform	2.2 m	n/a

Notes:

(1) Hardstanding for high-reach appliances should be as level as possible and should not exceed a gradient of 1 in 12.

Section 5: Access and Facilities for the Fire Service

5.5 Personnel Access to Buildings for Firefighting

5.5.1 Introduction

Access for personnel for firefighting purposes is required irrespective of the size or type of the building. The access may be necessary, even while evacuation is continuing in a building.

It is assumed that in low-rise buildings, medium-rise buildings or buildings with shallow basements, evacuation will have occurred before firefighting commences. Therefore, the requirements differ in the cases of such buildings from what applies in the cases of high-rise buildings and buildings with deep basements. In high-rise buildings and buildings with deep basements firefighting may be concurrent with continuing evacuation.

Where facilities are provided for fire services, these facilities should be made available from the fire service access level.

The following paragraphs provide guidance with respect to the various building types (see [Diagram 74](#)).

5.5.2 Basements

5.5.2.1 Basements < 10m

In basements with a lowest floor level of not more than 10 m below ground level, fire-service-personnel access requirements may be met by

- (a) the normal means of escape (see [Section 1](#)), which includes protected stairs; and
- (b) the measures for perimeter vehicle access as per [Table 24](#).

5.5.2.2 Basements < 10 m with Two or More Floors > 900 m²

In basements with two or more basement storeys, each with a floor area of more than 900 m², the problem of reaching the fire and working within a building, near the fire, merit the provision of additional facilities for firefighters (see [Diagram 74](#)).

These additional facilities are the provision of a minimum of 2 enhanced protected stairways (protected stairways with enhanced protection and facilities for firefighting), which consists of

- (a) 60-minute fire resistance (REI, each side separately); and
- (b) a fire main provided within the stairway.

All points on the floor should be no more than 45m from the entrance door to the stairway containing the fire main, measured on a route suitable for laying hose.

Where the basement is fitted throughout with an automatic sprinkler system (see [Section 8](#)), the maximum distance can be increased from 45m to 60m.

If the internal layout is unknown at the design stage, then every part of every such storey should be no more than two-thirds of the required distance.

Section 5: Access and Facilities for the Fire Service

5.5.2.3 Basements > 10 m

In basements with a lowest floor level more than 10m below ground level, fire-service-personnel access requirements may be met by the provision of a firefighting shaft (see [Diagram 74](#)).

Provisions for firefighting shafts are given in [Para 5.5.6](#).

5.5.3 Buildings with a Topmost Floor < 11 m

In buildings with a topmost floor level of less than 11 m, fire-service-personnel access requirements may be met by:

- (a) the normal means of escape (see [Section 1](#)), which includes protected stairs with a fire resistance of not less than 30 minutes (see [Appendix A, Table 31](#)); and
- (b) the provisions for vehicle access in [Para 5.4.2](#), which facilitate vehicle access to the building, and ladder access to upper storeys.

5.5.4 Buildings with a Topmost Floor > 11 m but < 20m

5.5.4.1 Buildings with Compartment Floors

Where every floor in a building is compartmented, i.e. a building containing flats, or a residential (care facility), residential (other), or shopping centre building (Purpose Groups 1(c), 2(a), 2(b), or 4(b)), with a topmost floor level greater than 11 m but less than 20 m, the problem of reaching the fire and working within a building, near the fire merit the provisions of additional facilities for firefighters. These additional facilities are the provision of a minimum of 1 protected shaft containing a stairway, with a fire main in the stairway (see [Diagram 74](#)).

For such buildings with a floor area of greater than 900 m², there should be a minimum of 2 such protected stairways. This provision does not apply to a building containing flats, however the hose length layout requirements should still be met.

Each storey should be designed such that the maximum distance, measured on a route suitable for laying hose when measured from the door to the stairway to all points on the storey should be no more than 45 m. To achieve this requirement, the building may require additional stairways in excess of the minimum number of stairways required. Where the building is fitted throughout with an automatic sprinkler system (see [Section 8](#)), this distance can be increased from 45 m to 60 m.

If the internal layout of a given storey is unknown at the design stage, then every part of the storey should be no more than two-thirds of the required distance suitable for laying a hose, e.g. 30 m in the case of a building without sprinklers, or 40 m in the case of a building with sprinklers.

Section 5: Access and Facilities for the Fire Service

5.5.4.2 Buildings without Compartment Floors

In other buildings, where every floor is not compartmented, perimeter access should be provided in accordance with [Para 5.4.2](#).

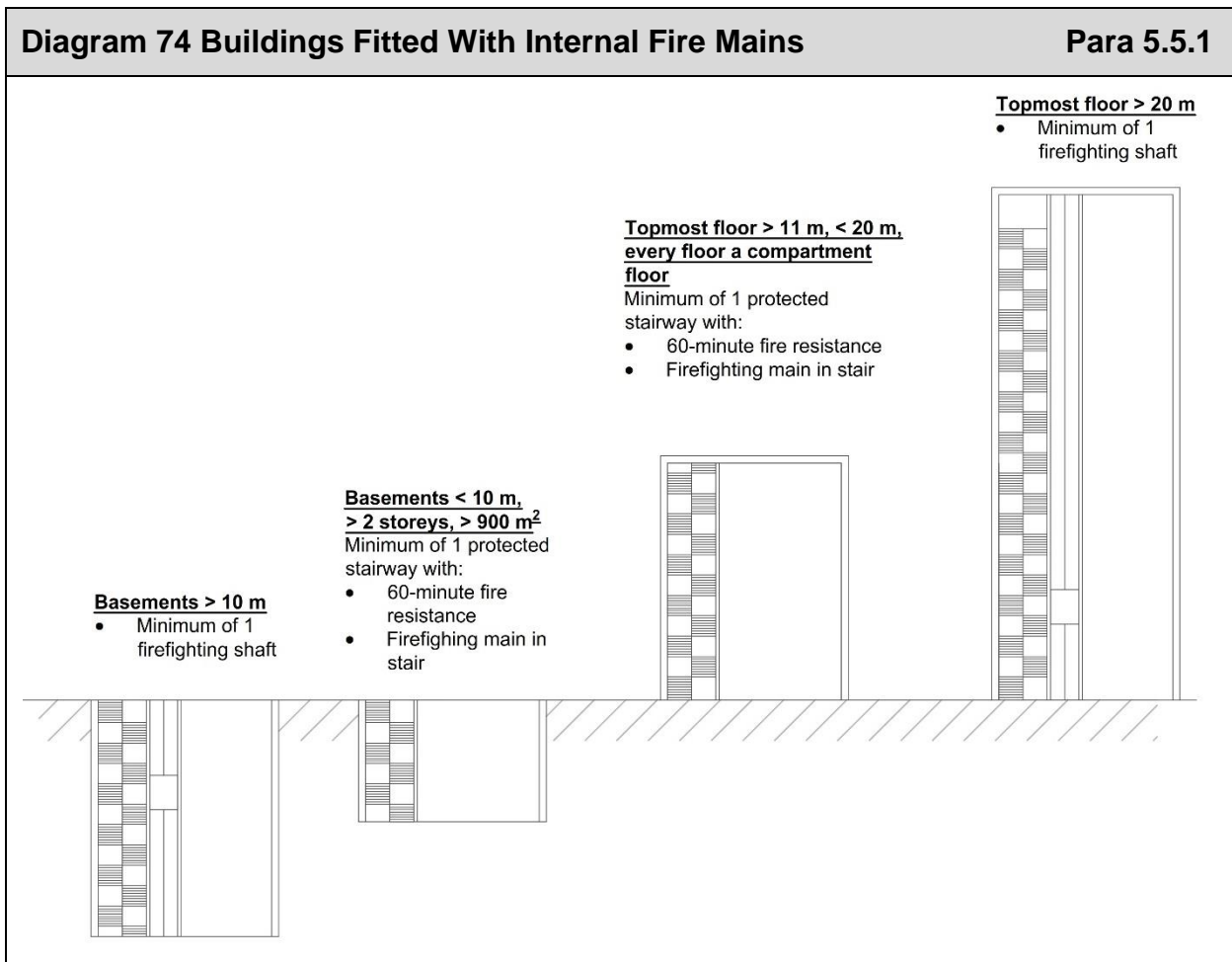

5.5.5 Buildings with a Topmost Floor > 20 m

In buildings with a topmost floor level greater than 20 m, the problems of reaching the fire, and working inside near the fire, merit the provision of additional facilities to avoid delay and to provide a sufficiently secure operating base to allow effective firefighting action to be taken, while maintaining the ability to evacuate the building (see [Diagram 74](#)).

These additional facilities include:

- a firefighting lift; and
- a firefighting stairway; and
- a firefighting lobby; and
- a firefighting main located in the firefighting lobby.

The additional facilities are combined in a protected shaft known as the firefighting shaft (see [Diagram 75](#)).

The firefighting lobby facilitates ongoing evacuation of occupants and concurrent firefighting operations.

Section 5: Access and Facilities for the Fire Service

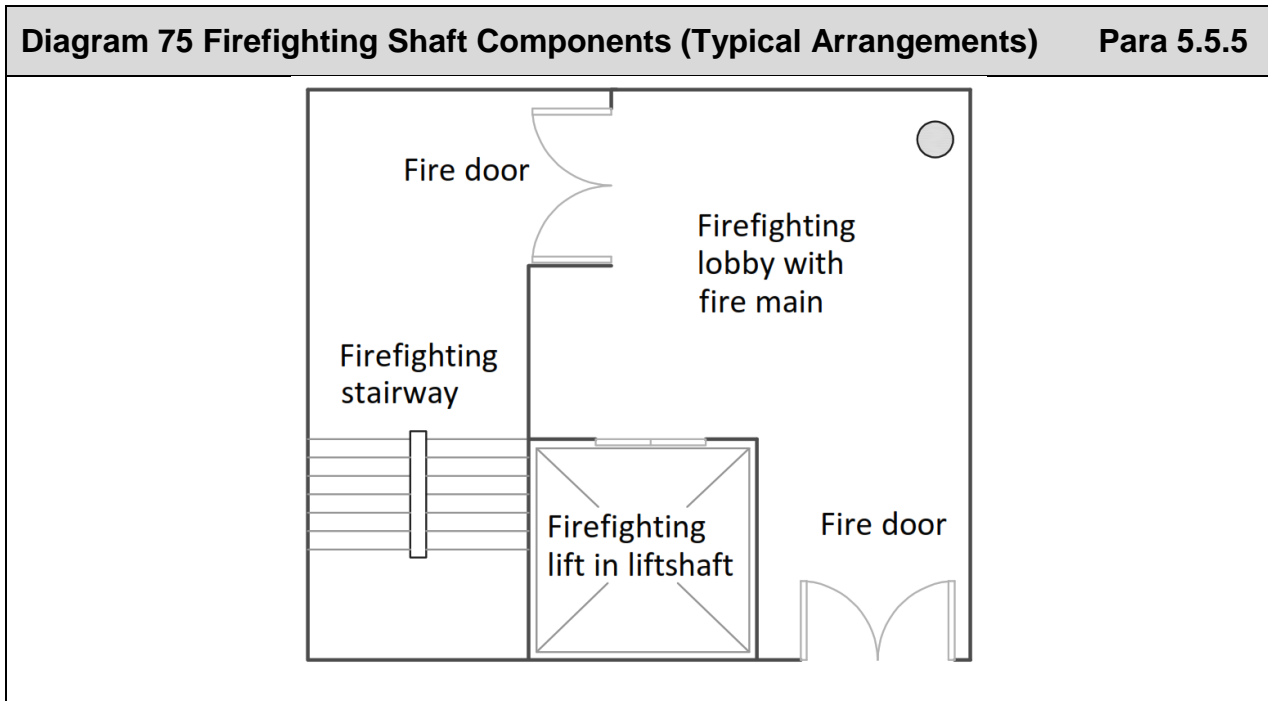

5.5.6 Provision and Number of Firefighting Shafts

Buildings with a topmost floor level at more than 20 m above ground level, or with a basement with a floor at more than 10 m below ground level, should be provided with firefighting shafts, as follows:

- (a) For buildings that have a topmost floor height above 20 m, there should be a minimum of 1 firefighting shaft;
 - (i) Where any such building has a floor above 20 m that exceeds 900 m², there should be a minimum of 2 firefighting shafts throughout the building. This provision does not apply to a building containing flats, however the hose length layout requirements should still be met;
- (b) For buildings with a basement with a floor more than 10m below ground level, there should be a minimum of 1 firefighting shaft;
 - (i) Where any such building has a floor below 10 m that exceeds 900 m², there should be a minimum of 2 firefighting shafts serving the basement.

Each storey should be designed such that the maximum distance, measured on a route suitable for laying hose when measured from the door to a firefighting shaft to all points on the storey should be no more than 45 m. To achieve this requirement, the building may require additional shaft(s) in excess of the minimum number of shafts required. Where the building is fitted throughout with an automatic sprinkler system (see [Section 8](#)), this distance can be increased from 45 m to 60 m.

If the internal layout of a given storey is unknown at the design stage, then every part of the storey should be no more than two-thirds of the required distance suitable for laying a hose, e.g. 30 m in the case of a building without sprinklers, or 40 m in the case of a building with sprinklers.

Section 5: Access and Facilities for the Fire Service

5.5.6.1 Planning and Layout of Firefighting Shafts

The planning and layout of a firefighting shaft, incorporating the four main elements of a firefighting shaft (see [Para 5.5.5](#)), should be in accordance with the following provisions of Para's 5.5.6.1 to 5.5.6.10.

5.5.6.1.1 Services

Only services associated with the firefighting shaft should pass through or be contained within the firefighting shaft.

Lifts designed as goods lifts or service lifts should not be located within fire-fighting shafts.

A firefighting shaft should not contain any cupboards or provide access to service shafts serving the remainder of the building.

Where a firefighting shaft contains sanitary accommodation, such accommodation should not:

- be used as a cloakroom; or
- contain any portable heating appliances; or
- contain any gas appliance other than a water heater or gas sanitary incinerator (see [Para 1.5.6.5](#)).

5.5.6.1.2 Storeys Served by a Firefighting Stairway and Firefighting Lift

The firefighting stairway and lift should satisfy the following requirements, (see [Diagram 76](#)):

- (a) A firefighting stairway should serve every storey of the building; and
- (b) A firefighting lift should serve every storey of the building. However, a firefighting lift need not serve any storey on which there is no entrance to any accommodation.

5.5.6.1.3 Extension of a Firefighting Shaft

The stair from a firefighting shaft may be extended into a part of the building not requiring a firefighting shaft, provided that either:

- (a) the firefighting shaft is extended accordingly, including the provision of firefighting lobbies and any fire main; or
- (b) the extension to the stair is separated from the firefighting shaft by fire- resisting construction (see [Diagram 76](#) (c)).

5.5.6.2 Location of Firefighting Shaft

A firefighting shaft should either:

- (a) be located on an external wall, or
- (b) be located no more than 18 m from an external wall and accessed only by way of a protected corridor (see [Diagram 76](#)) which should meet the following provisions:

Section 5: Access and Facilities for the Fire Service

- (i) The protected corridor should have a fire resistance equal to that of the firefighting shaft (see [Appendix A, Table 31](#)); and
- (ii) The protected corridor should be 0.5 m wider than the width required for means of escape purposes (see [Subsection 1.4](#)), where the corridor satisfies the dual function of firefighter access and means of escape from ground-floor accommodation; and
- (iii) Where such a corridor is accessed directly from the accommodation, it should be accessed only by lobbies, with doors complying with [Appendix B, Table 36](#).

It should not be necessary for persons escaping down the stair to pass through the firefighting lobby at fire-service-access level.

5.5.6.3 Construction of Firefighting Shafts

Firefighting shafts should meet all of the following provisions:

- (a) Have the necessary fire resistance specified in [Appendix A, Table 31](#).
- (b) Have an external wall which achieves the same fire resistance as the firefighting shaft enclosure, for a distance of 5 m (see [Diagram 76](#)), where a firefighting shaft wall and an external wall form a re-entrant angle, of $< 110^\circ$. For a re-entrant angle $> 110^\circ$ in buildings of all uses, excluding residential (care facility) buildings (Purpose Group 2 (a)) the external wall should achieve a fire resistance of 60 minutes for a distance of 0.5m (see [Diagram 76](#)). In residential (care facility) buildings (Purpose Group 2 (a)), this distance should be 1.0 m.
- (c) Have walls (excluding external walls) which are constructed from materials achieving Class A2-s3, d2, and which meet the criteria given in [Table 26](#) when tested in accordance with BS 5234-2:1992 Annex F (severe duty), unless the walls are constructed of materials such as brick or concrete.
- (d) Have ceilings, stairs and landings within the firefighting shaft which are constructed from materials achieving Class A2-s3, d2.
- (e) Not contain glazed areas unless
 - (i) it is an external wall (other than a wall that should be fire resisting (see (b) above); or
 - (ii) the glazed element complies with (a), (c) and (d) above; or
 - (iii) the glazed element is fire resisting in terms of integrity, the glazed area is provided in a fire door, and its area does not exceed 0.1 m².
- (f) Have doors between the fire-fighting stair and fire-fighting lobby which are free from any fastenings, and doors from the fire-fighting lobby into the accommodation which have fastenings that can be readily and easily openable by the fire and rescue service.

Table 26 Tests for Walls Forming Firefighting Shafts		Para 5.5.6.3	
Test	Severity	Criteria for compliance	
Stiffness ⁽¹⁾	500 N	No significant damage, maximum deflection ⁽²⁾ 10mm and residual deflection 1 mm	
b) Small hard-body impact: ⁽³⁾			
1) surface damage	10 N/m	No significant damage	
2) perforation	30 N/m	No perforation	
c) Large soft-body impact: ⁽⁴⁾			
1) damage	100 N/m	2 mm maximum deformation	
2) structural damage	120 N/m	No collapse or dislocation	
d) Crowd pressure	1.5 kN/m	No collapse or dangerous damage ⁽⁵⁾	
Notes:			
(1) Force applied via a 150-mm-diameter plate.			
(2) Deflection of the partition from the vertical.			
(3) Body is a 50-mm steel sphere.			
(4) Body is spheroconical bag, 600 mm x 400 mm, filled with hardened glass beads.			
(5) Force applied by a 2.5 m horizontal beam.			

5.5.6.4 Firefighting Lobbies

Every firefighting stairway and firefighting lift should be approached through a firefighting lobby (see [Diagram 76](#)).

In a building containing flats (Purpose Group 1(c) (see Subsection 1.6), there should not be direct access to a flat or ancillary accommodation from a firefighting lobby (see [Diagram 77](#)).

The firefighting lobby (see [Diagram 76](#)) should be designed to conform to all of the following:

- (a) Be designed such that the lobby layout is appropriate for use by firefighters in carrying out firefighting operations, having regard to escape routes and the position of doors; and
- (b) Reduce, as far as is practicable, risks arising from the direct exposure of lift landing doors to the effects of fire through the doorway leading into the accommodation; and
- (c) Have a contiguous clear floor area for use by firefighters, of not less than 5 m² but not more than 20 m² for lobbies with up to 4 lifts, or 5 m² per lift, for lobbies with more than 4 lifts; and
- (d) Have principle dimensions of not less than 2m, but not more than 8m in lobbies with up to 4 lifts, or 2m per lift, for lobbies with more than 4 lifts; and
- (e) Have facilities for smoke control (see [Subsection 6.3](#)). A natural (see [Para 6.3.2](#), [Para 6.3.3](#)) or mechanical (see [Para 6.3.5](#)) ventilation system may be used in buildings with a topmost floor height of up to 30 m. In buildings with a topmost floor height of more than 30 m, a mechanical (see [Para 6.3.5](#)) ventilation system, or an equivalent natural system, proven by fire engineering analysis should be used.

Section 5: Access and Facilities for the Fire Service

5.5.6.5 Firefighting Stairs

Stairways in firefighting shafts should:

- (a) be constructed of materials with a reaction-to-fire classification achieving A2 - s3, d2, or better (see [Para 1.9.4](#)); and
- (b) have a minimum clear width between the walls or balustrades, (Strings and handrails intruding not more than 30mm and 100mm respectively may be ignored) of no less than 1.1 m; and
- (c) have a clear headroom of not less than 2 m, measured vertically from the pitch line or landing-floor level, over the whole width of the stairs.

Where a firefighting shaft serves floors above and below ground, the firefighting stairs should be separated at ground floor level by a fire door (see [Diagram 76](#) (c)).

Winder, helical or spiral stairs should not be used to form a firefighting staircase, owing to the uneven spacing/width of the stair treads.

5.5.6.6 Firefighting Lift Installation

A firefighting lift installation includes the lift well (shaft), the lift car itself and the lift machinery space, together with the lift control system and the lift communications system and electrical supply.

Firefighting lift installations should:

- (a) conform to I.S. EN 81-20 and I.S. EN 81-72; and
- (b) have lift landing doors with a fire resistance in accordance with [Appendix B, Table 36](#); and
- (c) serve every storey, with the exception of any storey on which there is no entrance to any accommodation, or the topmost storey of the building if it consists exclusively of plant rooms; and
- (d) have lift doors that are power-operated; and
- (e) have permanent means to effectively prevent water ingress into the lift well (see I.S. EN 81-72, Annex E, E2).

5.5.6.7 Fire Mains

All firefighting shafts should be equipped with internal fire mains having outlet connections and valves in every firefighting lobby except at access level (see [Para 5.3.2](#)).

A fire main should be located so as to not obstruct an escape route, or a refuge area, and be located so as to optimise the use of the fire main for firefighters in carrying out firefighting operations.

Further guidance in relation to the installation of fire mains is contained I.S. 391.

Section 5: Access and Facilities for the Fire Service

5.5.6.8 Emergency Lighting for Firefighting Shafts

Emergency lighting is normally provided for means-of-escape purposes (see [Para 1.9.8](#)). Where not already provided, each firefighting shaft should have emergency lighting luminaries at the following locations:

- (a) at each final exit and outside the building; and
- (b) in any access corridor at ground floor (where provided) constructed as part of the firefighting shaft leading to the firefighting stairs (see [Diagram 76](#)); and
- (c) at each flight of stairs; and
- (d) at each landing; and
- (e) near each piece of firefighting equipment; and
- (f) near signs provided for firefighting purposes; and
- (g) in each firefighting lobby; and
- (h) in any corridor providing access to a firefighting stairs.

Further guidance on emergency lighting is contained in I.S. 3217.

5.5.6.9 Signs for Firefighting Shafts

The provision of adequate signage for the purposes of means of escape is specified in [Para 1.9.12](#). Where a firefighting shaft (see [Para 5.5.5](#)), or a stairway is provided for firefighting purposes (see [Para 5.5.2](#), and [Para 5.5.4](#)), there are additional requirements for signs to assist firefighters in carrying out firefighting operations.

Signs should be provided as follows:

- (a) A storey identification sign, in each firefighting stairs, at each storey landing, that identifies the floor by number; and
- (b) A storey identification sign, in each firefighting lobby, that identifies the floor by number.

Where there is more than one firefighting shaft in a building, the storey identification number should be supplemented by a shaft identification number (e.g. A-1, A-2, etc., or similar).

Further information with respect to signs is contained within I.S. EN ISO 7010.

5.5.6.10 Primary and secondary power supplies

Many firefighting installations specified in this document require both primary and secondary (emergency, standby or alternative) power supplies. Where secondary power supplies are provided within the same building as the installation they serve, the room containing the secondary supply system should have the same level of protection required for the installation they serve.

Section 5: Access and Facilities for the Fire Service

5.5.6.10.1 Power Supplies

Where electrical services in the building are essential to maintaining the effectiveness of fire-fighting facilities, a suitable secondary power supply should be provided that is capable of operating safely in fire conditions. When determining the means for the provision of a secondary supply, the overall electrical distribution system within the building should be taken into account, as well as the power needs for other equipment requiring a secondary or standby power supply.

Power supplies should be installed and labelled in accordance with the provisions of I.S. 10101.

Alternative power supplies, where required, should conform to the following:

- (a) Changeover from primary to secondary power supply should be automatic;
- (b) Both the primary and secondary sources of power to the fire-fighting shaft should be sufficiently protected against fire and water damage, and should also be separated from each other;
- (c) The primary electrical supply to a fire-fighting lift should be obtained from a sub-main circuit exclusive to the lift and independent of any other main or sub-main circuit;
- (d) The secondary power supply should:
 - (i) Be independent of the primary power supply to the fire-fighting shaft,
 - (ii) Be capable of providing the power for a fire-fighting lift within 30 s of the failure of the primary electrical supply.
 - (iii) Be designed to operate for at least 3 h;
 - (iv) be of sufficient capacity to maintain in operation the appropriate firefighting systems, e.g. the fire-fighting lift and its ancillary equipment; normal lighting and other services within the fire-fighting shaft; any fire service communications system; any powered ventilation or pressurization system; any pump(s) required to feed the fire main;
 - (v) be organized such that the secondary supply remains live when the remainder of the supplies in the building are isolated in an emergency.

Cables, switchgear and other equipment transmitting the secondary power supply should be separated from those of the primary supply or physically protected so that a breakdown, or any cause of a breakdown on one supply, does not lead to simultaneous failure of the other supply.

Diagram 76 Firefighting Shafts

Para 5.5.6

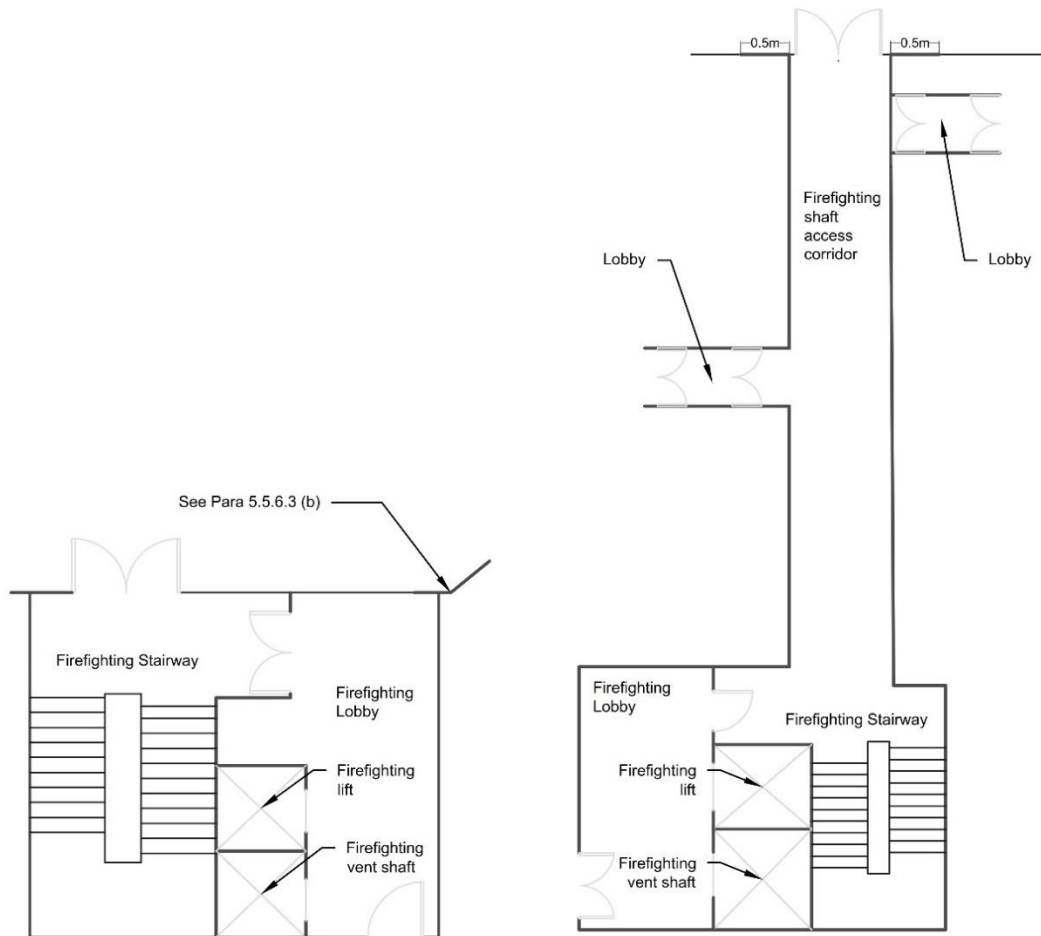

a. Firefighting shaft, access level, direct-to-outside access

b. Firefighting shaft, access level, corridor access to firefighting shaft

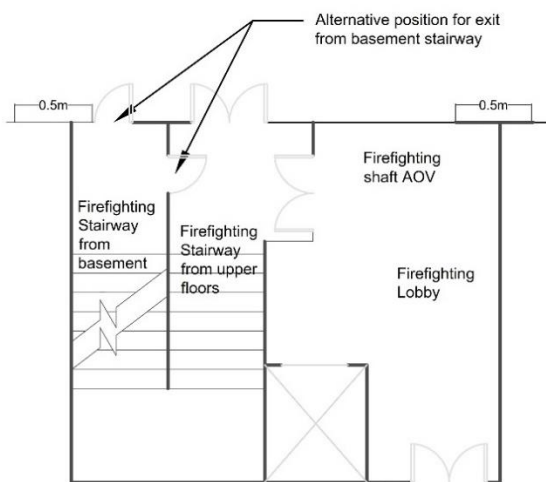

c. Firefighting shaft, access level, direct access to firefighting shaft, basement access

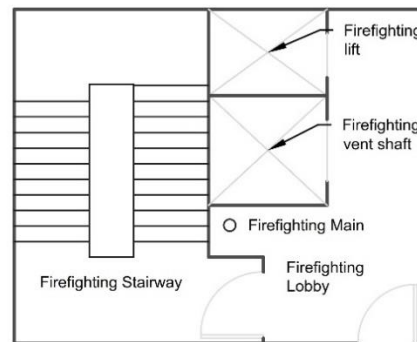

d. Firefighting shaft, accommodation level

Notes:

(1) Where stairs extend to a part of a building that does not require a fire fighting shaft, see [Para 5.5.6.1.3](#)

Section 5: Access and Facilities for the Fire Service

Diagram 77 Firefighting Shafts in Buildings Containing Flats

Para 5.5.6

a. Ground or access level

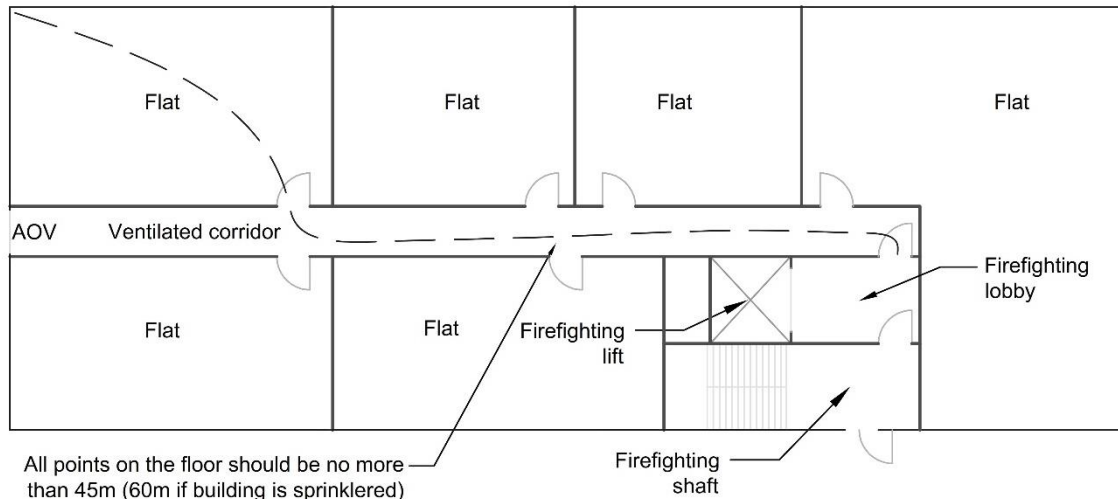

All points on the floor should be no more than 45m (60m if building is sprinklered) from the entrance door to the firefighting shaft, measured on a route suitable for laying hose (See Para 5.5.6).

b. Upper level

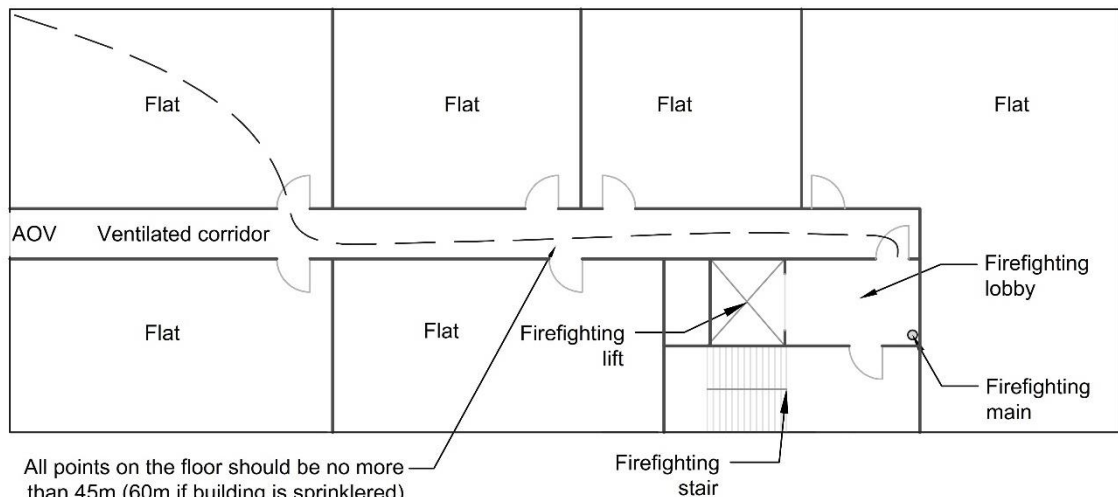

All points on the floor should be no more than 45m (60m if building is sprinklered) from the entrance door to the firefighting shaft, measured on a route suitable for laying hose (See Para 5.5.6).

Section 5: Access and Facilities for the Fire Service

5.6 Areas Requiring Special Consideration

There are a number of situations which pose particular difficulties and in which additional facilities should be provided to assist the fire services.

5.6.1 Boiler Rooms and Fuel Stores

In buildings where the heating installation is oil-fuelled, and in particular where the oil storage tanks and oil-burning equipment are situated below ground level, a fire involving the fuel and equipment can be tackled by the fire brigade using foam, which is introduced into the heating or storage chamber through foam inlets.

Every room which contains oil-burning equipment or has storage tanks of greater capacity and situated as in [Table 27](#) should be provided with a foam inlet for use by the fire brigade.

Table 27 Provision of Foam Inlets		Para 5.6.1
Location of room	Contents	Provision of foam inlets
Wholly below ground and area greater than 45 m ²	Heating appliance(s) > 45 kW Oil storage tank(s) > 2,000 litres	One inlet per 45 m ² of floor area of the room
Accessible only from inside the building	Heating appliance(s) > 45 kW Oil storage tank(s) > 2,000 litres	One inlet per 45 m ² of floor area of the room

To ensure that the fire brigade personnel are able to use the inlet without hindrance from heat and smoke which may emerge from the opening, the inlet should be sited on an external wall not more than 0.9m above ground level and at least 3 m horizontally from any opening to the protected room. The external wall should have the required fire resistance as specified in BS 5410-2.

The pipe from its inlet coupling should have an internal diameter of 80mm (nominal), be without acute bends and should not exceed 10 m in length to the point of discharge of the foam. Inlets should be fitted with a 63.5 mm instantaneous coupling complying with BS 336.

The inlet should be located no more than 18 m from a hardstanding, and within sight of a fire appliance.

The discharge of foam should be so arranged to impinge on a wall approximately 0.9 m above the floor level of the room or 150 mm above the catch pit level, whichever is the higher.

For fire safety of bulk storage woody biomass fuel, see Technical Guidance Document J.

Section 5: Access and Facilities for the Fire Service

5.6.2 Isolation of Electrical Supply for Firefighting

The electrical supplies to a building can present fire brigade personnel with a considerable danger during firefighting operations. It is therefore necessary to provide a switch or switches, readily accessible to firefighters, which will enable them to turn off and isolate the electrical supply before commencing firefighting.

A means to isolate the following should be provided:

- electrical supply to the premises, and
- discharge lighting (where installed), and
- photovoltaic arrays (where installed).

5.6.2.1 Premises Isolation Switches

Switch/s required to isolate the electrical supply of the building in the event of fire should be installed in accordance with the recommendation in I.S. 10101, Section 539.

5.6.2.2 Discharge Lighting

One or more switches should be provided to enable the fire service personnel to switch off the discharge lighting in the event of a fire.

Such switches are needed where exterior discharge lighting (e.g. advertising signs) and/or interior discharge lighting systems are provided. The switches should be readily accessible and conspicuously marked to enable firefighters to switch them off without delay.

A firefighter's switch should be provided for:

- exterior discharge-lighting installations operating at a voltage exceeding low voltage; and
- interior discharge-lighting installations operating unattended at a voltage exceeding low voltage.

For the purposes of these provisions, an installation in a closed market or in an arcade is considered to be an exterior installation.

For the purpose of the above provisions, low voltage is defined as not exceeding 1000 V ac, or 1500 V dc between conductors, or 600 V ac or 900 V dc between any conductor and earth.

Every such firefighter's switch should comply with I.S. EN 60669-2-6 or I.S. EN 60947-3.

Section 5: Access and Facilities for the Fire Service

5.6.2.2.1 Requirements for Switches

Every firefighting switch provided should comply with all the relevant requirements of the following:

- (a) For exterior installations, the switch should be outside the building and adjacent to the discharge lamp(s), or, alternatively, a notice indicating the position of the switch should be placed adjacent to the discharge lamp(s), and a name plate should be fixed near the switch so as to render it clearly distinguishable.
- (b) For interior installations, the switch should be in the main entrance to the building or at the fire-service access point.
- (c) The switch should be placed in a conspicuous position, reasonably accessible to firefighters and, at not less than 2.75 m from the ground or the standing beneath the switch.
- (d) Where more than one switch is installed on any one building, each switch should be clearly marked to indicate the installation or part of the installation which it controls.

Wherever practicable, all exterior installations on any one building should be controlled by a single firefighter's switch.

Similarly, all internal installations in any one building should be controlled by a single firefighter's switch independent of the switch for any external installation.

5.6.2.3 Photovoltaic Panels

Where photovoltaic (P.V.) panels are provided on buildings, provision should be made for the isolation of the panel array in accordance with I.S. 10101, Section 712.

Where such panels are installed, a sign shall be provided at the main power distribution board, and at the main fire alarm panel, indicating the presence and location of solar panels on the building.

Further information with respect to signs is contained within I.S. EN ISO 7010.

Section 6: Smoke Control Systems

Section 6 Smoke Control Systems

6.1 Introduction

6.1.1 Use of this Section

Fires in buildings can often result in an accumulation and entrapment of smoke and hot gasses in the building, compartment or separated part. The accumulation of heat and smoke in a fire may inhibit or prevent evacuation, impact on the fire resistance of structures, and / or prevent access to fire areas and limit the potential for rescue and effective firefighting from within the building.

Ventilation of heat and smoke, by means of a smoke control system, plays an important role in supporting the objectives of adequate means of escape, outlined in [Section 1](#) supporting fire-resistance requirements for elements of structure ([Section 3](#)), and assisting firefighting ([Section 5](#)).

The provision of natural ventilation in above-ground car parks (typically referred to as “open-sided car parks”) can also have an impact on external fire spread ([Section 4](#)), by increasing the amount of unprotected area on a façade, thereby increasing the required distances to a notional boundary.

Ventilation is not a substitute for sprinklers or other extinguishing facilities. Its purpose is to release smoke and heat from the building, support escape, and to improve accessibility for the fire services.

Certain requirements for smoke control systems apply irrespective of the use (Purpose Group) of the building, as follows:

- (a) For buildings with a protected stairway, see [Subsection 6.2](#).
- (b) For buildings with a firefighting shaft, see [Subsection 6.3](#).
- (c) For buildings containing atria, see [Subsection 6.4](#).
- (d) For certain basements, see [Subsection 6.5](#).

In addition to these requirements, certain uses also require smoke control systems, as follows:

- (e) For buildings containing flats, see [Subsection 6.6](#).
- (f) For industrial and storage buildings, with large undivided and windowless spaces, see [Subsection 6.7](#).
- (g) For car parks, see [Subsection 6.8](#).
- (h) For assembly and recreation buildings, see [Subsection 6.9](#).
- (i) For shopping centres, see [Subsection 6.10](#).

Section 6: Smoke Control Systems

Care should be taken in the design of smoke control systems in buildings where there are multiple requirements, e.g. a tall building containing a flat, where it is necessary to provide adequate ventilation to the common protected corridors(s) / lobbies, the firefighting lobby, and the protected stairway.

Sections or areas within a building may have specific requirements for smoke control. However, where there are multiple requirements, the smoke control systems provided for the building overall must be considered holistically, such that one system does not operate contrary to another.

In such circumstances, the appropriate design of a smoke control system may serve to satisfy such multiple requirements. For example, the provision of adequate ventilation to common protected corridors / lobbies in buildings containing flats may preclude the necessity of ventilating a firefighting lobby, in buildings over 20 m.

Smoke control may be achieved by

- (a) ventilation openings to the exterior of the building, whether by wall or roof; or
- (b) ventilators to smoke shafts; or
- (c) roof- or wall-mounted mechanical ventilators.

Any smoke control system should be capable of operating at all material times, including where the system is powered by electricity.

Outlet vents provided for the purposes of smoke control, whether natural or mechanical, should be located, having regard to the location of inlet vents to ensure that smoke exhausted from the building does not re-enter the building via inlet vents.

6.1.2 Location of Wall-Mounted Vents

Where a wall-mounted vent is provided, it should be:

- (a) a minimum of 1.0m from a relevant boundary; or
- (b) orientated such that it is not facing a site boundary (see [Para 4.4.2](#)) where the external wall is within 1m of the site boundary.

6.1.3 Mechanical Vents

Where mechanical ventilators are provided, they should conform to the following:

- (a) They should be a minimum Class F300 (Temperature/time classification of 300° for 60 minutes) in accordance with I.S. EN 12101-3; and
- (b) Ductwork and fixings should be constructed of materials having a melting point not less than 800°C, or a fire resistance of not less than 60 minutes (EI).

Section 6: Smoke Control Systems

6.1.4 Measurement of Natural Vents

Where natural vents are provided they should meet the performance as set out in this Section.

The vent area of the vents should be taken as the total unobstructed cross-sectional area (geometric free area), measured in the plane where the area is at a minimum and at right angles to the direction of air flow (see [Diagram 78](#)).

This may be achieved by vents conforming to I.S. EN 12101-2.

6.1.5 Natural Vent to a Smoke Shaft

Where vents to natural smoke shafts are specified, they should:

- Meet the equivalent free vent area as specified under Para 6.1.4; or
- have a minimum fire and smoke resistance performance of 60 min and a leakage rate no greater than $200 \text{ m}^3/\text{h}/\text{m}^2$ when tested in accordance with I.S. EN 1366-2; or
- be in accordance with I.S. EN 12101-8; or
- have a proven equivalent performance.

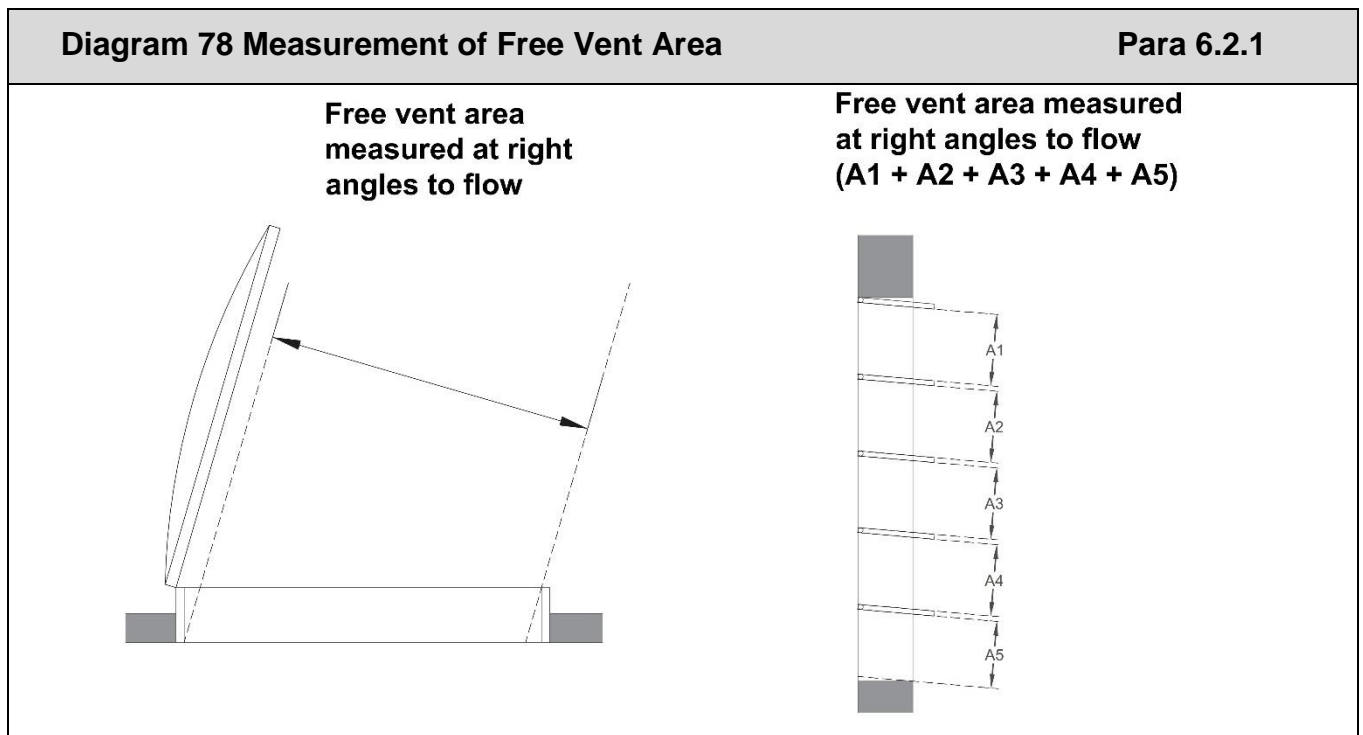

Section 6: Smoke Control Systems

6.2 Protected Stairways

6.2.1 Ventilation of Common Protected Stairway Enclosures

Smoke control in escape stairways is of assistance in the evacuation of a building and, at the later stages in the development of a fire, in the carrying out of fire brigade operations.

An automatic opening vent should be provided at the top of each common-access protected stairway enclosure. Such a vent may be roof or wall mounted. Wall vents should be bottom or side hinged. A basement stairway which discharges directly to the outside may be ventilated by means of the final exit door to the stairway.

Where the vent is wall mounted, the top of the vent should be fitted as close to the top of the ceiling of the stairway as is practicable, but it should be at least as high as the top of the door connecting the accommodation to the stairwell.

This vent should have an unobstructed free vent area of not less than 1 m².

This vent should be automatically opened by the fire detection and alarm system, on activation of smoke detectors in the stairway enclosure, and should also be manually openable for fire brigade use.

The manual override should be provided at ground/fire service entrance level to the stairs and the provided with clear signage as to its function and operation, for fire service use only.

Private stairways, e.g. in a maisonette, are not required to be ventilated.

6.2.2 Ventilation of Lobbies to Protected Stairways or lifts

Any protected lobby or corridor at basement level which has direct access to a stairs or lift should be ventilated by means of permanent openings to the open air having an area not less than 0.05 m², or a mechanical extraction system providing equivalent ventilation performance in accordance with [Para 6.1.3](#).

Where a protected lobby or corridor provides access to a stairway or lift at any storey level from an enclosed car park or area of special fire risk, the lobby should be ventilated by means of permanent openings to the open air having an area not less than 0.4 m², or a mechanical extraction system providing equivalent ventilation performance, in accordance with [Para 6.1.3](#).

Where any ventilated lobby or corridor is not adjacent to an external wall of the building, any connecting ventilation ductwork should be fire resisting, or protected by fire-resisting construction.

Section 6: Smoke Control Systems

6.3 Ventilation of Firefighting lobbies

6.3.1 Introduction

Where a firefighting shaft is required, i.e. in a building with a topmost floor level over 20 m, or a basement at more than 10 m below ground, the firefighting stair and firefighting lift should be approached from the accommodation through a ventilated firefighting lobby.

In buildings containing flats, the provision of a natural or mechanical smoke ventilation system to protected corridors / lobbies used to satisfy [Para 6.6](#) may also be sufficient to satisfy the requirements for ventilation of the firefighting lobby.

6.3.2 Natural Automatic Vents Opening Directly to the Exterior of the Building

Where ventilation is provided by means of an automatic opening vent(s) (AOV) from the firefighting lobby to the exterior of the building, it should conform to the following provisions:

- (a) The lobby vent should have a minimum free area of 1.5 m² measured in accordance with [Para 6.1.4](#), at each storey to the exterior of the building; and
- (b) The lobby vent should be fitted as close to the top of the ceiling of the protected corridor/ lobby as is practicable, but be at least as high as the top of the door connecting the protected corridor / lobby to the stairwell or lobby; and
- (c) Inlet air to the lobby should be provided by means of an AOV to the stair with a minimum clear area measured in accordance with [Diagram 78](#) of 1 m²; and
- (d) The design of the system should be such that, on detection of smoke in the firefighting lobby, by means of the fire detection and alarm system, the ventilator on the fire floor, and the ventilator at the head of the stairway should all open simultaneously. All other vents should remain in the closed position.

Fire and rescue service override controls should not permit multiple lobby vents to be open simultaneously. Override controls should be at the fire service access point.

Section 6: Smoke Control Systems

6.3.3 Natural Automatic Vents Opening to Natural Smoke Shafts for Firefighting Lobbies above Ground

Natural smoke shafts to firefighting lobbies above ground should conform to all of the following provisions:

- (a) The smoke shaft should be fully open to the external air at the top only; and
- (b) The opening at roof level should be at least 0.5 m above the roof, and be at least 0.5 m above any surrounding structures within a horizontal distance of 2.0 m; and
- (c) The smoke shaft should have a minimum cross-sectional area of 3.0 m² (minimum dimension 1.0 m in any direction); and
- (d) The minimum vent area from the firefighting lobby into the shaft, should 1.5 m² (minimum dimension 0.75 m in any direction); and
- (e) The minimum vent area at the head of the shaft should be at least 2 m²; and
- (f) All internal restrictions within the shaft such as safety grilles should have a minimum geometric free area of 2.5 m²; and
- (g) The top of the lobby vent should be located as close to the ceiling of the lobby as is practicable, and should be at least as high as the top of the door connecting the lobby to the stairwell; and
- (h) The smoke shaft should be constructed in accordance with [Para 3.5.16](#) and Appendix A; and
- (i) The ventilation openings from the lobby to the vent shaft should have a fire resistance of 60 minutes; and
- (j) No services other than those relating to the smoke shaft should be contained within the smoke shaft; and
- (k) The shaft should be vertical from base to head but may have not more than 4m at an inclined angle not more than 30° from the vertical plane; and
- (l) The design of the system should be such that, on activation of the fire detection and alarm system, the ventilator on the fire floor, the ventilator at the top of the smoke shaft and the 1 m² ventilator at the head of the stairway should all open simultaneously. All other vents to the smoke shaft should remain in the closed position; and
- (m) Meet the provisions of [Para 6.1.5](#).

Section 6: Smoke Control Systems

6.3.4 Natural Automatic Vents Opening to Natural Smoke Shafts to Firefighting Lobbies below Ground

Natural smoke shafts to firefighting lobbies below ground should conform to all of the following provisions:

- (a) Smoke shafts serving basements should discharge direct to open air at or above ground level where the exits from the building and fire service access would not be affected by the smoke discharge; and
- (b) A smoke shaft should be covered with either:
 - (i) a metal grille designed to prevent blockage of the shaft by rubbish; or
 - (ii) an AOV; and
- (c) The smoke shaft should conform to the provisions as set out in [Para 6.3.3](#) (c) to (m).

6.3.5 Mechanical Smoke Ventilation System

A mechanical smoke ventilation system should:

- (a) have a proven equivalent performance to a natural smoke shaft specified at Para 6.3.3 above; and
- (b) The design of the system should be such that, on activation of the fire detection and alarm system, the ventilator on the fire floor, the mechanical ventilator at the top of the smoke shaft and any inlet air vent should open simultaneously; and
- (c) Where there are multiple shafts due to multiple corridors, the system should be designed to activate the relevant shaft only. The ventilators from the common protected corridors / lobbies on all other floors, and unaffected corridors on the fire floor should remain closed; and
- (d) The design of the mechanical smoke ventilation system should limit pressure differentials so that door opening forces do not exceed 100 N at the door handle when the system is in operation; and
- (e) A secondary power supply should be provided to the fans and all actuators and controls; and
- (f) Fan sets should be provided with a standby fan that operates automatically upon failure of the duty fan; and
- (g) Mechanical ventilation fans and ductwork should conform to the provisions of [Para 6.1.3](#).

Section 6: Smoke Control Systems

6.4 Buildings Containing Atria

6.4.1 Introduction

Many large modern buildings contain an atrium, which is a void passing through one or more compartment floors (see [Subsection 0.10](#)). Storeys in the building may be open to the atrium, or they may be separated by fire-resisting construction.

Where an atrium passes through compartment floors, with the possibility of fire or smoke spread between storeys, additional provisions are needed to ensure the adequate protection of persons escaping the building. The accumulation of smoke which enters the atrium may also impact on the means-of-escape provisions (see [Section 1](#)).

In a compartment floor, such an opening requires special provisions (see [Para 3.8.3](#)), which include provisions of a system for the removal of smoke.

Such a system may be a smoke clearance system (see [Para 6.4.2](#)), a smoke control system (see [Para 6.4.3](#)), or a pressurisation system (see [Para 6.4.4](#)).

In an atrium, smoke control systems are designed to move or control the smoke and hot gasses in a predetermined manner so that their threat to life can be minimised.

Further guidance on the design of smoke control systems provided to an atrium is given in BR 368 and BR 258, and BS 7346.

6.4.2 Smoke Clearance Systems

Where a natural smoke clearance system is specified within an atrium, the system should either:

- (a) Be a natural ventilation system, with a total area of vents should not be less than 10 % of the maximum plan area of the atrium, and with the vents located at the top of the enclosure; or
- (b) Be a mechanical ventilation system which provides replacement air changes every hour based upon the total volume of the atrium, including the largest floor open to the atrium with an inlet at low level, at four air changes per hour in sprinklered buildings (see [Section 8](#)) or six air changes per hour in unsprinklered buildings.

The system should be designed to be activated by the fire services, by means of a manual switch. A natural smoke clearance system may be used for atria not exceeding 30 m in height. A mechanical ventilation system may be used in atria of any height.

Section 6: Smoke Control Systems

6.4.3 Smoke Control Systems

Where a smoke control system is specified within an atrium, the system should:

- (a) maintain a clear layer of not less than 3 m above the topmost open occupied storey, or 2.5 m above the floor of fire origin; and
- (b) ensure that the smoke layer temperature does not exceed 200 °C; and
- (c) ensure that, where the smoke layer descends below closed storeys, smoke cannot leak into these floors — and, where applicable, ensure by dilution, that the optical density per metre will not exceed 0.1% at all points on the topmost storey open to the atrium. This measure is intended to ensure that visibility on the open storeys does not reduce below 8 m to 10 m, which is deemed adequate for safe use of the escape routes; and
- (d) be activated by the building fire detection and alarm system.

The smoke control system provided to an atrium should be designed to achieve the above requirements, in accordance with BS 7346-4, BR 368 or BR 186.

6.4.3.1 Make-Up Air Supply

For smoke control systems and smoke clearance systems, make-up air is essential. The following provisions apply:

- (a) It is essential that there should be sufficient provision of make-up air, with a velocity into the atria base not exceeding 2 ms⁻¹ for the proper functioning of any smoke ventilation, or smoke clearance system specified for the atrium; and
- (b) If not permanently open, all inlets should open simultaneously on activation of the smoke ventilation system that they serve; and
- (c) The maximum velocity of air passing through an escape route should be 5 ms⁻¹, and the smoke control system should be designed to avoid excessive pressures opposing the opening of escape doors located in the air flow; and
- (d) The inlets for replacement air should be located at a low level in the atrium, or alternatively at high or low level in other smoke control zones unaffected by the fire and communicating with the affected smoke control zone only at low level.

Section 6: Smoke Control Systems

6.4.4 Pressure Differential Systems

Pressure Differential systems for an atrium can be divided into three specific types, as follows:

- (a) Pressurization of the atrium. Where there is no appreciable fire-load in the atrium, and all storeys are separated from the atrium by fire-resisting construction, the atrium can be regarded as being fully analogous to a protected stairway and can be pressurized in a similar way relative to the accommodation to prevent ingress of smoke into the atrium from any storey. For this type of system, Para 6.4.4.1 (a), (b), (e), and (f) should be applied; or
- (b) Pressurization of associated floor areas. Where there is a sprinklered or controlled fire load in the atrium base, smoky gas can fill all or part of the atrium. Where storeys are separated from the atrium by fire-resisting construction, and where there is no smoke and heat exhaust ventilation from the atrium, the adjacent accommodation spaces (and/or any stairwells or shafts communicating via doors into the atrium) may be pressurized relative to that atrium. For this type of system, Para 6.4.4.1 (a), (b), (c) and (d) should be applied; or
- (c) Depressurization of the atrium. Where there is a controlled fire load in the atrium base, and where some or all higher storeys are separated from the atrium by fire-resisting construction, and where there is smoke and heat exhaust ventilation for the atrium, it might be feasible to reduce the pressures in the atrium sufficiently to prevent smoke entering adjacent spaces through leakage paths. For this type of system, Para 6.4.4.1 (a), (b), and (f) should be applied.

6.4.4.1 Design Provisions for Pressure Differential Systems

The design provisions for pressure differential systems are as follows

- (a) The building should be protected with a sprinkler system (see [Section 8](#)) designed and installed in accordance with I.S. EN 12845. A sprinkler system, however, is not required where:
 - (i) the atrium is less than 30 m high; and
 - (ii) the atrium is separated from the associated areas by fire-resisting construction; and
 - (iii) there is a pressure differential system protecting the associated areas from smoke in the atrium; and
 - (iv) the fire safety engineering design solutions do not require the presence of sprinklers.
- (b) Where the atrium might contain smoke, and it is desired to pressurize adjacent accommodation storeys and/or stairwells and/or shafts, the height of the neutral pressure plane in the atrium should be assessed by calculation under BS 7346-4, allowing for normal building leakage.

Section 6: Smoke Control Systems

- (c) The minimum design pressure difference across a closed door (or other leakage path) between an atrium and an adjacent pressurised space should be 50 Pa for heights up to 10 m above the neutral pressure plane, and 75 Pa for heights between 10 m and 25 m above the neutral pressure plane.
- (d) Any part of the enclosure separating the atrium from the associated storey areas, which is more than 25 m above the calculated neutral pressure plane, should be of smoke-retarding construction as well as having a fire resistance of not less than 30 min, irrespective of any other requirements.
- (e) Where smoke ingress into the atrium is to be prevented by pressurising the atrium in accordance with the relevant sections in IS EN 12101-6 as if it were a pressurised stairwell, there should be no combustible content in the atrium and the adjacent spaces should be separated from it by a fire-resisting construction.
- (f) Where smoke and heat exhaust is used to reduce the pressure in an atrium containing thermally-buoyant smoky gases, the design objective should be to raise the neutral pressure plane above the highest vulnerable leakage path, allowing for external wind pressures explicitly in the design calculation.

Section 6: Smoke Control Systems

6.5 Basements

Smoke ventilation from basements (excluding basement car parks, see Subsection 6.7) generally takes the form of outlet vents connected directly to the open air (see [Diagram 79](#)).

Smoke outlets connecting directly to the open air should be provided from every basement storey, except for any basement storey that has both of the following:

- (a) a maximum floor area of 200 m²; and
- (b) a floor level, which is not greater than 3 m below the adjacent ground level.

Where a basement is compartmented, each compartment should be ventilated separately.

A basement storey or compartment containing rooms with doors or windows direct to the open air does not need smoke outlets.

Smoke vents should be sited at high level and should be distributed around the building perimeter to maximise the effectiveness of cross-ventilation. The clear cross-sectional area of all smoke vents, allowing for frames and louvres, should not be less than 2.5% of the basement storey served. Any natural vent shaft used for the ventilation of the basement should not be less in cross-sectional area than the vent serving it.

Smoke outlets should be:

- (a) Covered only with a grille or louvre achieving a reaction-to-fire classification of A1; or
- (b) Capable of venting smoke from the basement automatically.

Smoke outlets should not be located within 1.8 m of an escape route from the building.

As an alternative to outlet vents as described above, a system of mechanical extraction may be provided, where the basement is also protected by an appropriate sprinkler system (see [Section 8](#)). The ventilation system should meet the criteria set out in [Para 6.8.3.2](#) and should operate automatically on activation of the sprinkler system.

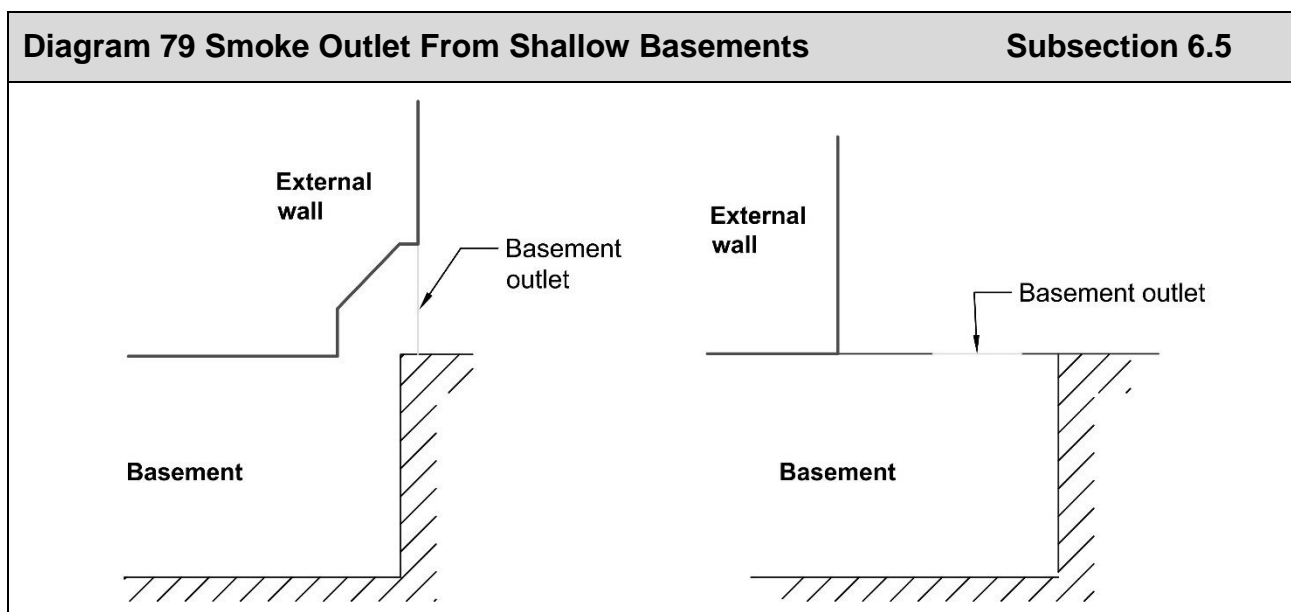

Section 6: Smoke Control Systems

6.6 Buildings Containing Flats

6.6.1 Introduction

This section provides guidance in relation to smoke control systems for protected corridors / lobbies which provide a means of escape from flats.

6.6.2 Smoke Control System for Protected Corridors / Lobbies

A smoke control system for a protected corridor / lobby is installed to facilitate escape in corridors / lobbies. It may be a natural (see [Para 6.6.2.1](#), [Para 6.6.2.2](#)) or a mechanical ([Para 6.6.2.3](#)) system.

In a building with a floor level at more than 20 m above ground level, the provision of an adequate smoke control system to a protected corridor / lobby may be sufficient to ventilate the firefighting lobby (see [Para 5.5.6](#), and [Subsection 6.3](#)).

The smoke control system should be designed to ventilate the protected corridor / lobby for means of escape. Any smoke control system installed in a building containing flats should be designed such that tenable conditions for means of escape within the corridor / lobby are maintained.

The smoke control system should be activated by means of an appropriate fire detection and alarm system.

6.6.2.1 Natural Automatic Vents Opening Directly to the Exterior of the Building

Where ventilation is provided by means of an automatic opening vent(s) (AOV) from the protected corridor / lobby to the exterior of the building, the system should conform to the following provisions:

- (a) The lobby / corridor vent should have a minimum free area of 1.5 m² in accordance with [Para 6.1.4](#); and
- (b) The lobby corridor vent should be fitted as close to the top of the ceiling of the protected corridor/ lobby as is practicable, but be at least as high as the top of the door connecting the protected corridor / lobby to the stairwell or lobby; and
- (c) Inlet air should be provided through an automatic opening vent having a clear openable area of not less than 1 m² located at the top of the stairway enclosure; and
- (d) Where there are multiple AOV's due to multiple corridors, the system should be designed to activate the relevant AOV only. The AOVs from the common protected corridors / lobbies on all other floors should remain closed.

Section 6: Smoke Control Systems

6.6.2.2 Automatic Vents Opening to Natural Smoke Shafts

Where ventilation is provided by means of an automatic opening vent(s) (AOV) from the protected corridor / lobby to natural smoke shaft, the system should conform to all of the following:

- (a) The minimum ventilation area from the protected corridor / lobby into the shaft, and at the opening at the head of the shaft, and at all internal locations within the shaft (e.g. safety grilles) should be at least 1 m², in accordance with [Para 6.1.5](#); and
- (b) The top of the protected corridor / lobby vent should be located as close to the ceiling of the protected corridor / lobby as is practicable, and should be at least as high as the top of the door connecting the protected corridor / lobby to the stairwell or lobby; and
- (c) The ventilation openings from the protected corridor / lobby to the vent shaft should achieve the same fire performance as the shaft, but not exceeding 60 minutes; and
- (d) The smoke shaft should have a minimum cross-sectional area of 1.5 m² (minimum dimension 0.85 m in any direction); and
- (e) The natural smoke shaft should be closed at the base; and
- (f) The shaft should extend a minimum length of 2.5 m above the ceiling of the highest storey which is served by the shaft; and
- (g) The opening at roof level should be at least 0.5 m above any surrounding structures within a horizontal distance of 2.0 m; and
- (h) The smoke shaft should be constructed in accordance with [Para 3.5.16](#); and
- (i) No services other than those relating to the smoke shaft should be contained within the smoke shaft; and
- (j) The shaft should be vertical from base to head but may have not more than 4m at an inclined angle not more than 30° from the vertical plane; and
- (k) Inlet air should be provided through an automatic opening vent having a clear openable area of not less than 1 m², in accordance with [Para 6.1.4](#), located at the top of the stairway enclosure; and
- (l) The design of the system should be such that, on activation of the fire detection and alarm system, the ventilator on the fire floor, the ventilator at the top of the smoke shaft and the 1 m² ventilator at the head of the stairway should all open simultaneously.

Where there are multiple shafts due to multiple corridors, the system should be designed to activate the relevant shaft only. The ventilators from the common protected corridors / lobbies on all other floors, and unaffected corridors on the fire floor should remain closed.

Section 6: Smoke Control Systems

6.6.2.3 Mechanical Smoke Ventilation

A mechanical smoke ventilation system should:

- (a) have a proven equivalent performance to a natural smoke shaft specified at Para 6.6.2.2 above; and
- (b) The design of the system should be such that, on activation of the fire detection and alarm system, the ventilator on the fire floor, the mechanical ventilator at the top of the smoke shaft and any inlet air vent should open simultaneously; and
- (c) Where there are multiple shafts due to multiple corridors, the system should be designed to activate the relevant shaft only. The ventilators from the common protected corridors / lobbies on all other floors, and unaffected corridors on the fire floor should remain closed; and
- (d) The design of the mechanical smoke ventilation system should limit pressure differentials so that door opening forces do not exceed 100 N at the door handle when the system is in operation; and
- (e) A secondary power supply should be provided to the fans and all actuators and controls; and
- (f) Fan sets should be provided with a standby fan that operates automatically upon failure of the duty fan; and
- (g) Mechanical ventilation fans and ductwork should conform to the provisions of [Para 6.1.3](#).

Section 6: Smoke Control Systems

6.7 Large Undivided or Windowless Spaces in Industrial or Storage Buildings

Large undivided floor areas can present difficult firefighting problems. The accumulation of heat and smoke in a fire may prevent access to these areas and limit the potential for rescue and effective firefighting from within the building. The provision of smoke and heat venting can greatly improve the effectiveness of such operations. This can particularly occur in large windowless accommodation, where a fire has very limited ability to vent to the outside.

Facilities for ventilation of smoke and heat should be provided in single-storey buildings or single-storey compartments, exceeding 4,000 m² in area (see Appendix C, [Diagram 87](#)), having the following uses:

- industrial (Purpose Group 6); or
- storage (Purpose Group 7).

The space below the roof generally requires division into smoke reservoirs of appropriate dimensions, and the provision of adequate ventilation.

Ventilation may be provided either:

- (a) by natural ventilators, with the appropriate clear vent area (see [Diagram 78](#)); or
- (b) by the nature of the roof/building fabric, such as by the use of rooflights which are designed to fail in the event of a fire.

Inlet air may be provided by adjacent reservoirs or by means of external windows, doors, or low-level smoke inlets.

Guidance on the design of ventilation systems is given in CEN TR 12101- 5.

Section 6: Smoke Control Systems

6.8 Car Parks

6.8.1 Car Parks

The provisions necessary to ventilate a car park will depend on the type of car park, which may be either:

- (a) open-sided (see [Para 3.8.2.2](#)); or
- (b) non-open-sided (see [Para 3.8.2.3](#)).

6.8.2 Ventilation of Open-Sided Car Parks

For car parks which are considered as open-sided, there should be permanent open ventilation at each level of not less than 5% of the floor area at that level. This ventilation should provide a level of cross ventilation of not less than 2.5% divided equally (i.e. 1.25%) on two opposing walls. The remainder of the ventilation area (2.5%) should be equally distributed around the perimeter of the building

6.8.3 Ventilation of Non-Open-Sided Car Parks

Non-open-sided car parks require ventilation which may be by natural or mechanical means, as set out below, or equivalent, e.g. an impulse fan system installed to BS 7346-7.

6.8.3.1 Natural Ventilation

Each storey should be naturally ventilated by permanent openings at each level having an aggregate area not less than 2.5% of the floor area at that level. This ventilation should provide a level of cross ventilation of not less than 1.25% divided equally on two opposing walls. The remaining free area should be distributed as appropriate so as to maximise the effectiveness of the ventilation.

Smoke vents at ceiling level may be used as an alternative to the provision of permanent openings in the walls. They should have an aggregate area of permanent opening totalling not less than 2.5% of the floor area, and be arranged to provide a through draught.

Section 6: Smoke Control Systems

6.8.3.2 Mechanical Ventilation

In some non-open-sided car parks (i.e. basement car parks, or car parks which are totally enclosed), it may not be possible to obtain the minimum standard of natural ventilation openings set out above. In such cases, a system of mechanical ventilation should be provided as follows:

- (a) The system should be independent of any other ventilating system (other than any system that provides day-to-day ventilation to the car park) and be designed to operate at 10 air changes per hour in a fire condition; and
- (b) The system should be designed to run in two parts, each part capable of extracting 50% of the rates set out in (a) above, and designed so that each part may operate singly or simultaneously; and
- (c) Each part of the system should have an independent power supply which would operate in the event of failure of the main supply; and
- (d) Fan sets should be provided with a standby fan that operates automatically upon failure of the duty fan; and
- (e) Outlets for exhaust air should be arranged so that 50% of the outlets are at high level and 50% at low level; and
- (f) Mechanical ventilators should be in accordance with [Para 6.1.3](#); and
- (g) The system should be designed such that smoke is not directed towards storey exits.

Section 6: Smoke Control Systems

6.9 Assembly and Recreation Buildings

Any system of mechanical ventilation in an assembly and recreation building should, in addition to the provisions for ventilation systems (see [Para 3.7.3](#)) comply with the following relevant provisions:

- (a) Any such system serving the parts of the premises to which the public are admitted should be independent of the remainder of the premises.
- (b) If the premises is used for stage presentations, any such system should be designed to ensure that the air movement during performances is directed from the auditorium, away from the audience, and may be towards the stage (see [Para 6.9.1](#)).
- (c) Any such system above a stage provided with a proscenium opening (see [Para 1.4.8.1](#)) should be entirely independent of the auditorium system.

6.9.1 Ventilation for Open Stages

Exhaust ventilation should be provided over any open stage (see [Para 1.4.8.2](#)). The extract system over an open stage should be sized to keep the auditorium relatively clear of smoke during the period of evacuation in the event of a fire on stage.

The size and minimum fire resistance of the system should be determined according to the size of the stage. Unless determined otherwise, exhaust ventilators over an open stage should have a combined total aerodynamic free area at least 10% of the area of the stage.

Stage ventilators should open automatically on activation of a fire detector in the stage area.

6.9.2 Proscenium Stage Ventilation

Ventilation should be provided above the stage grid in order to ensure that the safety curtain is effective in a fire. This ventilation may be provided by openable vents or by a powered system.

Separated stage ventilation should meet the following provisions:

- (a) A separated stage should be provided with ventilation at high level above the stage grid either:
 - (i) by natural ventilators providing an aerodynamic free area of 10% of the area of the stage; or
 - (ii) by two or more mechanical ventilators designed to provide a total exhaust air flow equivalent to that recommended in (i) above; and
- (b) Stage ventilators should open automatically on activation of a fire detector in the stage area; and
- (c) Manual switches for the operation of the stage ventilation should be provided – one on the working side of the stage, and one outside of the stage area; and
- (d) The stage ventilation system should be designed to be effective in all wind directions.

Section 6: Smoke Control Systems

- (e) Any air quality ventilation systems operating within the stage area should cease functioning on the operation of the stage smoke control system; and
- (f) The clear vent area of natural ventilators should be measured in accordance with [Para 6.1.4](#).
- (g) Mechanical ventilators should be in accordance with [Para 6.1.3](#).

Section 6: Smoke Control Systems

6.10 Enclosed Shopping Centres

Smoke control should be treated as an integral part of the design of an enclosed shopping centre (see [Subsection 1.7](#)).

In every covered mall section of a shopping centre, effective smoke control measures should be taken which will ensure that the smoke from the largest design fire which occurs in any unit or other occupancy, or in any common area, will not endanger those using any mall or walkway as an escape route.

6.10.1 General

Adequate arrangement(s) should be made in each smoke reservoir for the removal of smoke in a way that will prevent the formation of stagnant regions.

Where natural ventilators are installed, they should have an aggregate clear vent area to ensure that the performance specified under [Para 6.10.2](#) is met. The clear vent area of natural ventilators should be measured in accordance with [Diagram 78](#).

All smoke control equipment (excluding natural ventilators) should be in accordance with the appropriate Parts of I.S. EN 12101. Mechanical ventilators should be in accordance with [Para 6.1.3](#).

Any air-conditioning ventilation ductwork used in conjunction with the smoke ventilation system should comply with [Para 3.7.3](#)

Further guidance on the design of smoke control systems provided to an enclosed shopping centre is given in BR 368, BR 258, BS 7346, or EN 12101.

6.10.2 Mall Smoke Control

Smoke control zones should be so designed and arranged that:

- (a) The base of the smoke layer in a zone will be not less than 3 m above the level of the mall or walkway; and
- (b) Zone boundaries are formed by:
 - (i) structural elements, or permanent down stands, of an effective depth, having a minimum fire resistance of E30; or
 - (ii) smoke curtains tested to I.S. EN 12101-1, of an effective depth, with a performance of at least 30 minutes; and
 - (iii) The area of mall within the smoke control zone does not exceed 1000 m² (1,300 m² if powered ventilation is used); and
- (c) The length of each zone, measured along the centre line of the mall, does not exceed 60 m; and

Section 6: Smoke Control Systems

- (d) Units discharging smoke into mall zones either:
 - (i) have a plan area not exceeding 1000 m² (1300 m² if powered ventilation is used); or
 - (ii) are subdivided, such that smoke is vented to the mall from parts of the unit with a plan area not exceeding 1000 m² (1300 m² if the mall is provided with a powered ventilation system) that are adjacent to the mall. The remainder of the unit needs to be provided with an independent smoke ventilation system (see [Para 6.10.3](#)); and
- (e) Smoke which is discharged from any unit within a smoke control zone cannot pass into another smoke control zone.

6.10.3 Unit Smoke Control

Units and other occupancies with a plan area greater than 1,000 m² (1,300 m² if using powered ventilation in the mall) should:

- (a) Be subdivided into smoke control zones not exceeding 2,000 m² plan area (2,600 m² if using powered ventilation); and
- (b) Have structural elements and/or smoke curtains positioned in such a way, and of sufficient depth (taking into account the required exhaust rate), to prevent the passage of smoke into adjacent (and otherwise unaffected) smoke control zones; and
- (c) Be provided with a smoke ventilation system capable of serving only the smoke control zone(s) containing the smoke during the fire condition, and which is actuated by the fire detection and alarm system; and
- (d) Have sufficient inlet (replacement) air supplies to enable the smoke ventilation system to operate efficiently.

Parts of the unit adjacent to the mall with a plan area not exceeding 1,000 m² (1,300 m² if the mall is provided with a powered ventilation system) may discharge into the mall.

Section 7: Existing Buildings

Section 7 Existing Buildings

7.0 Use of this Section

7.0.1 Introduction

Where works or a material change of use is carried out on an existing building, the provisions of Sections 1 to 6 should be achieved, where possible.

However, in existing buildings, there may be constraints that would not exist in new buildings. In the case of existing buildings, therefore, some variations of the provisions set out in Sections 1 to 6 of this document may be appropriate. These are set out in this section (Section 7).

Where some of the provisions of Sections 1 to 7 cannot be reasonably achieved, compensating measures (see [Para 7.0.2](#)) may be considered. However, the principles of fire safety should be the same as those set out in Sections 1 to 6.

7.0.2 Compensating Measures for Existing Buildings

In some cases, the characteristics or constraints presented by works relating to an existing building may result in a situation where the provisions of Sections 1 to 7 cannot be reasonably achieved. Examples of such circumstances are given in the following non-exhaustive list:

- (a) Where the existing structural conditions would require moving or altering a load-bearing member which is an essential part of the overall structural stability of the building; or
- (b) Where other existing physical or site constraints would prohibit modification of an existing feature; or
- (c) Where the works would need to be carried out on part of a building, its facilities or its environs that is not under the same control/ ownership, e.g. in the case of a sub-leaseholder in a multi-occupancy building; or
- (d) Where specific alternative guidance to Sections 1 to 6 is provided in Section 7 and an existing feature or facility satisfies that guidance.

Many fire safety provisions are interdependent and should not be considered in isolation. Where a particular provision outlined in this document cannot be reasonably achieved, account may be taken of compensating fire-safety measures (see [Para 7.0.2.1](#), and [Para 7.0.2.2](#)), depending on the nature and circumstances of each particular case. Such measures may include active and / or passive provisions.

Section 7: Existing Buildings

7.0.2.1 Historic Buildings

Works relating to an existing building may present challenges, particularly buildings which are of architectural or historical interest. When considering works to a historic building, it is important to establish what is important or significant about the building.

A number of useful publications are available which outline alternative solutions to fire safety in existing buildings of special or historic merit.

These include (but are not limited to):

- Chapter 6 (page 89) and Chapter 17 of *Architectural Heritage Protection Guidelines for Planning Authorities*.
- *Fire Protection Measures for the Royal Palaces*, (U.K.).
- *Heritage Under Fire, A Guide to the Protection of Historic Buildings*.
- Guide for Practitioners 6: *Conversion of Traditional Buildings*.
- *Wood Information Sheet 1-32 Upgrading timber doorsets for fire resistance BM TRADA 2017*.

Other documents may be relied upon, provided that the performance objectives set out in this document are achieved.

7.0.2.2 Compensating Measures

Where compensating fire safety measures are proposed, the nature and extent of such measures will depend on the circumstances in each particular case.

However, such measures could include some or all of the following:

- enhanced levels of life safety protection by automatic fire detection and alarm systems; or
- reduced travel distances; or
- enhanced building systems to aid evacuation; or
- enhanced smoke control measures; or
- pressurisation of stairway enclosures; or
- protection to escape routes from places of special fire risk; or
- enhanced performance of fire doors; or
- additional structural fire protection measures, such as increased levels of compartmentation of the building (see [Section 3](#)); or
- automatic fire suppression and extinguishing systems; or
- significantly increased room heights; or
- additional facilities for firefighting, e.g. dry risers.

This list is neither exhaustive nor in any order of preference. It is indicative of the range of options that may be considered.

Section 7: Existing Buildings

7.0.3 Fire Performance

Provisions relating to fire performance (fire resistance and reaction to fire) are specified under Sections 1 to 6.

Fire performance in existing buildings may be met by classification to I.S. EN 13501 (*suite*), or for existing elements in existing buildings, to BS 476 (*suite*).

7.0.3.1 Reaction-to-Fire Classifications for Walls and Ceilings in Existing Buildings

Reaction-to-fire classifications for walls and ceilings in existing buildings may be classified to I.S. EN 13501-1, or for existing elements in existing buildings, to BS 476-6 and 7. The appropriate classifications (see [Appendix A](#)), when tested to either are shown in [Table 28](#)

Table 28 Reaction-to-fire Classifications		Para 7.0.3.1
Reaction-to-fire classification to I.S.EN 13501-1	Reaction-to-fire classification to BS 476 – 4, 6, 7, 11	
Class A1	Non-combustible materials ⁽¹⁾	
Class A2	Material of limited combustibility ⁽²⁾	
Class B	Class 0	
Class C	Class 1	
Class D	Class 3	
Notes: (1) See Annex A, A10 (2) See Annex A, A9 (3) Products classified to I.S.EN 13501 do not automatically equate with classifications to BS 476, and vice-versa. Therefore products cannot be assumed to have a European class or BS 476 class unless they have been tested and classified accordingly.		

7.0.3.2 Fire Resistance in Existing Buildings

Fire performance in existing buildings may be met by constructions which have achieved the required fire resistance when classified to I.S. EN 13501-2, I.S. EN 13501-3, I.S. EN 13501 - 4, or for existing elements requiring a fire resistance in existing buildings, to BS 476: 20 - 22.

Guidance on notional periods of fire resistance for specific constructions is provided in BR 128.

Section 7: Existing Buildings

Table 29 Reaction-to-fire Classifications		Para 7.0.3.3
Reaction-to-fire classification to I.S. EN 13501-5	Reaction-to-fire classification to BS 476 – 3	
B _{ROOF} (t4)	AA, AB or AC	
C _{ROOF} (t4)	BA, BB, or BC	
D _{ROOF} (t4)	CA, CB or CC	
E _{ROOF} (t4)	AD, BD or CD	
F _{ROOF} (t4)	DA, DB, DC or DD	
<p>Notes:</p> <p>(1) Products classified to I.S.EN 13501 do not automatically equate with classifications to BS 476, and vice-versa. Therefore products cannot be assumed to have a European class or BS 476 class unless they have been tested and classified accordingly.</p>		

7.0.3.3 Reaction-to-Fire Classifications for Roofs in Existing Buildings

Reaction-to-fire classifications for roofs in existing buildings may be classified to I.S. EN 13501-5, or for existing roof build-ups in existing buildings, to BS 476-3. The appropriate classifications (see Appendix A, Table 35) when tested to either are shown in [Table 29](#).

Thatch or wood shingles:

- (a) Should not be used on a roof of any building, which is located within 6 m of a boundary.
- (b) Should not be used on a roof of any industrial building (PG 6), storage (PG 7), or other non-residential building (PG 8).
- (c) Should not be used on a roof of any PG 1c, 2a, 2b, 3, 4a, 4b, 5a, 5b building which has a cubic capacity exceeding 1500 m³.
- (d) May be used in building located no less than 6 m from the boundary, provided that:
 - (i) it is a PG 1c, 2a, 2b, 3, 4a, 4b, 5a, 5b building, and
 - (ii) the building has a cubic capacity not exceeding 1500 m³, and
 - (iii) the part of the roof is no more than 3 m² in area and is at least 1.5 m from any similar part, with the roof between the parts covered with a material of limited combustibility.
- (e) May be used in building no less than 12 m from the boundary, provided that:
 - (i) it is a PG 1c, 2a, 2b, 3, 4a, 4b, 5a, 5b building; and
 - (ii) the building has a cubic capacity not exceeding 1500 m³.

Section 7: Existing Buildings

7.1 Means of Escape

7.1.1 Application to Existing Building

The following paragraphs relate to the application of the means-of-escape provisions of the Building Regulations to existing buildings.

7.1.2 Works to an Existing Building

Where a building, or an extension has been built, or a material change of use has taken place since 1 June 1992, the provisions of TGD B should be followed when works, including a material alteration, are proposed.

Where a building has existed since before 1 June 1992, and it has not been the subject of a material change of use since 1 June 1992, material alterations of existing elements to which this document relates, within such a building may be carried out in accordance with any relevant guide published by the NDFEM for the purpose of providing guidance in relation to satisfying obligations under Section 18(2) of the Fire Services Acts 1981 and 2003.

Any new elements, added to an existing building should meet the relevant provisions as set out under Section 1 – 6. Any existing elements, to be retained as part of the fabric of the existing building may meet the provisions set out in this Section.

7.1.3 Horizontal Escape

Where a material alteration or a material change of use takes place, the provisions for horizontal means of escape, as set out under Section 1.4, should be applied.

However, in the specific case of a material alteration of a building containing flats, the fire resistance of fire doors to an existing protected entrance hallway should be not less than E 20 / FD 20.

In the case of an existing doorset in an existing building, the clear effective width of doors can be measured in accordance with [Diagram 80](#).

For existing doors in existing buildings, the width of escape routes should conform to [Table 30](#)

As an alternative to outward-opening doors, where required, in certain limited situations it may be appropriate to consider the provision of inward –opening hinged doors which are held in the open position. It should not be possible for such doors to be released and closed when the building is in use.

Section 7: Existing Buildings

Diagram 80 Measurement of Door Width in Existing Buildings

Para 7.1.3

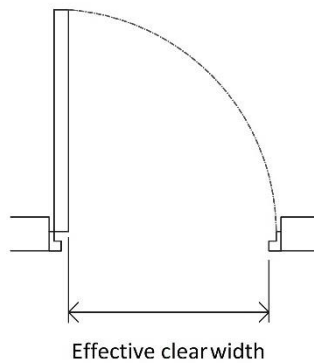

Table 30 Width of Escape Routes and Exits in Existing Buildings

Maximum number of persons	Minimum width (mm) ⁽¹⁾ ⁽²⁾ ⁽³⁾
50	750

Notes:

- (1) The minimum widths given in the table may need to be increased in accordance with the guidance in TGD M: Access and Use.
- (2) For > 50 persons, see [Table 5](#)
- (3) Applicable only to existing doors in existing buildings

7.1.4 Vertical Escape

Where a material alteration or a material change of use takes place, the provisions for vertical means of escape, as set out under [Subsection 1.5](#), should be applied.

However, where it is not possible to meet the relevant provisions as specified in [Subsection 1.5](#), the provisions of [Para 7.1.4.1](#) and [Para 7.1.4.2](#), as appropriate, may be applied.

7.1.4.1 Lobbies

In the case of a material change of use to an existing building, the provision of protected lobbies or corridors to an existing escape stairway may not be practicable. In these situations, it would be appropriate to consider the provision of compensating measures (see [Para 7.0.2](#) and [Para 7.0.2.2](#)) subject to adequately addressing the underlying risk of smoke spread into the escape stair enclosure.

The nature and extent of any additional measures required will depend on the circumstances of each particular case. Special provisions apply to single-stair office buildings, of limited height and size (see [Para 7.1.4.1.1](#)), and to buildings containing flats (see [Para 7.1.4.1.2](#)).

Section 7: Existing Buildings

Where protected lobbies or corridors cannot be provided, it will be necessary to consider the following items in the context of the need to ensure a satisfactory level of protection to the means of escape:

- The nature and extent of the occupancies and accommodation adjoining the protected stairway.
- The fire performance of the stairway enclosure.
- The performance of fire door assemblies as installed in the building (see [Appendix B](#)).
- Smoke control measures to protect the stairway enclosure.
- Life safety protection to be provided by the fire detection and alarm system (see [Para 1.9.13](#)).

7.1.4.1.1 Offices

In the particular circumstance of a material change of use to an existing building with a single stairway, where an office becomes so used, a lobby does not need to be provided to the stairway, if the following is satisfied:

- (a) There are no more than four storeys above ground; and
- (b) Self-closing fire doors are fitted with an automatic release mechanism; and
- (c) The total floor area of any floor does not exceed 250 m²; and
- (d) The fire alarm system is a minimum L1 system; and
- (e) An AOV has been provided to the stairway (see [Section 6](#)); and
- (f) The stairway does not directly connect with a basement.

If all the above are satisfied, the single stairway may be used as a circulation route.

7.1.4.1.2 Buildings Containing Flats

In the particular circumstance of a material change of use, of an existing building to a building containing flats with a single stairs, the provisions of [Para 1.6.6.1](#) may be applied, irrespective of the topmost floor height, provided that the building has not more than four storeys above ground level.

7.1.4.2 Width of Escape Stairways

The width of escape stairways should conform to [Table 7](#), with the exception of stairways in residential (care facility) buildings (Purpose Group 2(a)), where the minimum stairway width should not be less than 0.9 m.

In an existing building containing flats, the minimum width of the common escape stairway should be:

- (a) not less than 0.8 m, where no more than 50 persons are expected to use it; and
- (b) not less than 0.9 m, where no more than 100 persons are expected to use it.

Such a building should not have a topmost storey height greater than 20 m.

Section 7: Existing Buildings

7.1.4.3 Maisonettes accessed directly from the outside

Where a maisonette is accessed externally from the floor below the flat, and there are no rooms at that level, the provisions of [Para 1.6.3.2](#) apply from the lowest floor with a room (see [Diagram 81](#)), provided the following provisions are met:

- The enclosure to the stairway at access level should be formed of imperforate compartment walls; and
- The enclosure of the stairway within the maisonette at any other level should form a protected stairway; and
- A sprinkler system (see [Section 8](#)) should be provided throughout the maisonette, where there is a storey within the maisonette, of more than 7.5 m above the lowest floor of the maisonette with a room.

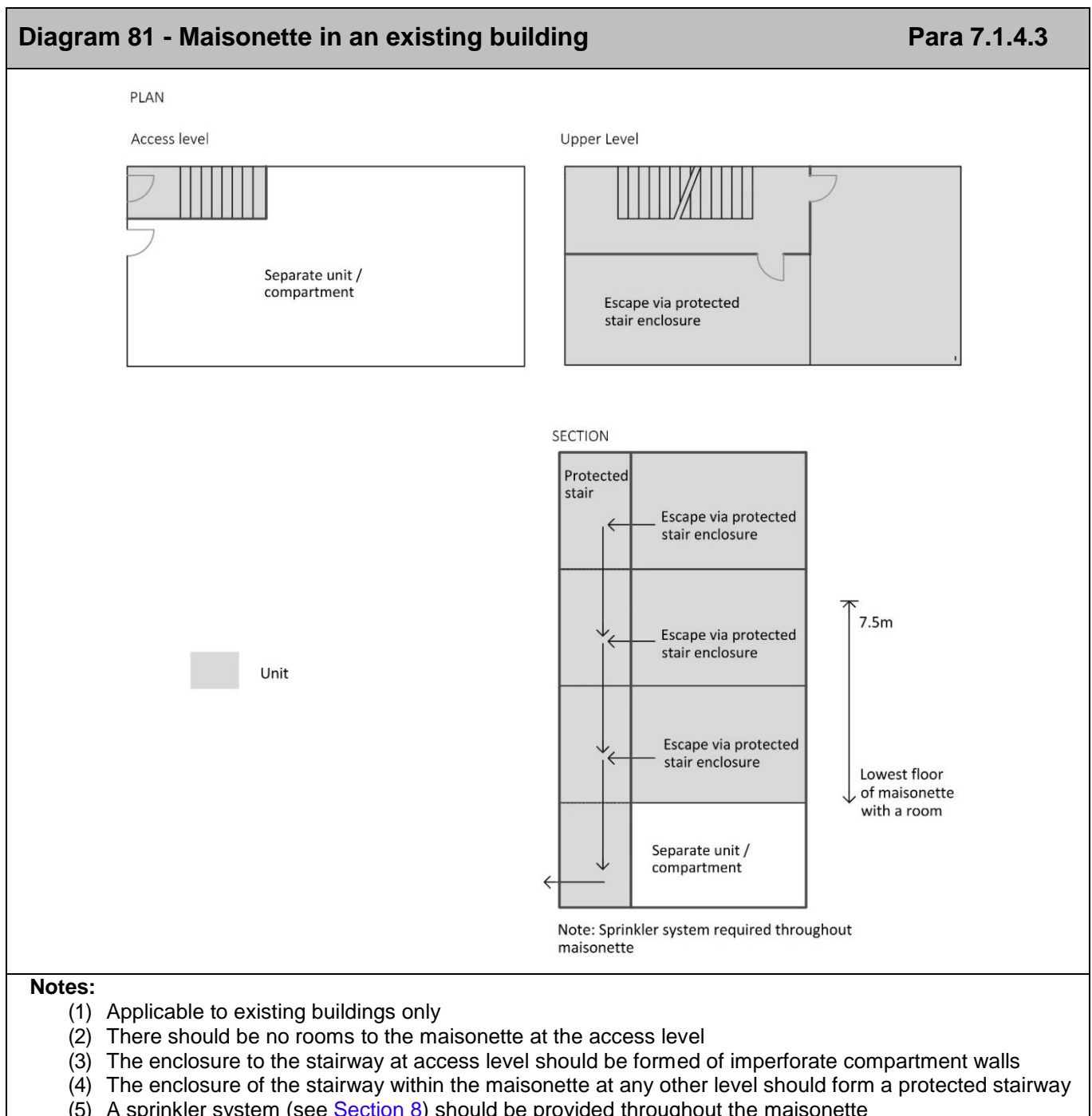

Section 7: Existing Buildings

7.1.4.4 Escape from a flat to an enclosed yard / garden

The escape route via a window from a flat should conform to [Para 1.6.4](#), with the escape route leading to a place of safety (see [Definitions 0.10](#)). However, in the case of an existing building, the escape route via a window may lead to an enclosed yard, provided that the depth of the garden exceeds the equivalent height of the whole building (see [Diagram 82](#)):

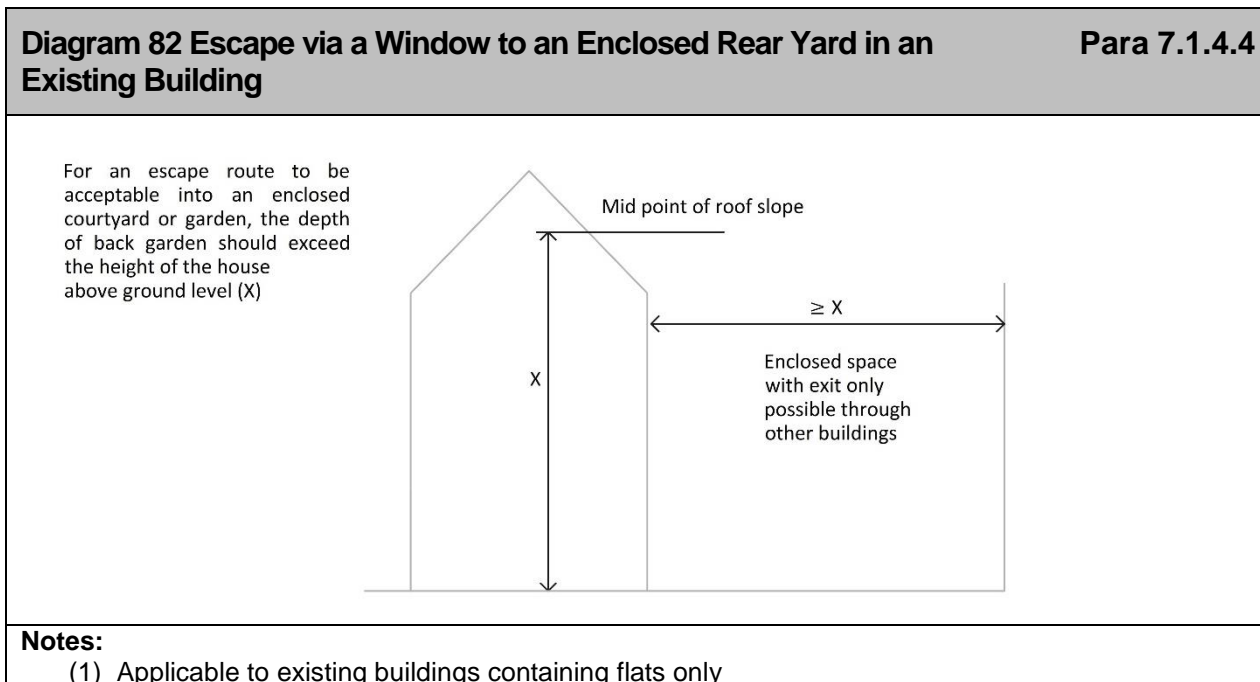

7.1.5 External Escape Routes

7.1.5.1 External Escape Stairway

Provisions relating to external escape stairways are specified under [Para 1.4.6.2](#).

In the case of an existing building, the use of an external escape stairway as an alternative means of escape may be acceptable. In such a building, there is no restriction on the height of the external escape stairway, provided that:

- (a) In the case of an assembly and recreation building, the number of persons likely to use the stairway should not exceed 150 persons; or
- (b) In the case of a residential (care facility) building (Purpose Group 2(a)), the route serves only office or residential staff accommodation.

For such buildings, the provisions relating to external escape stairways as specified under [Para 1.5.9](#) should be complied with.

Section 7: Existing Buildings

7.1.5.2 Escape Over Flat Roofs

Provisions relating to escape over flat roofs are specified under [Para 1.4.6.2](#).

In the case of any existing building, an escape route by way of a flat roof which complies with [Para 1.4.6.2](#) (b) to (e) may be acceptable as an alternative means of escape, where combined with an external escape stairway as outlined at [Para 7.1.5.1](#) above.

Where the building is used for assembly and recreation, the numbers of persons likely to use such an escape route should not exceed 150 persons.

7.1.6 Construction of Escape Stairways

Provisions relating to combustibility of stairways are specified under [Para 1.9.4](#).

An exception to the requirement for escape stairways to be constructed of materials of limited combustibility may be made in the case of an existing internal stairway in any existing building where:

- the width of the stairway and dimensions of steps are adequate for the purposes of means of escape; and
- the stairway is of sound construction and is capable of affording safe passage for the users of the building.

7.1.7 Small Premises

The provisions relating to small premises ([Subsection 1.8](#)) may be applied to an existing building where a material alteration of or a material change of use to a café (Purpose Group 5(a)(iv)) is proposed, provided that the facilities are limited to the re-heating of food. Any food preparation or re-heating area should be should be sited at the extremity of any dead end remote from any exit.

Section 7: Existing Buildings

7.2 Internal Fire Spread (Linings)

The linings in existing buildings should meet the performance as specified under Section 2. They may be classified in accordance with I.S. EN 13501-1 or BS 476 (see [Para 7.0.3.1](#)).

7.2.1 Existing Surfaces – Assessment of Performance

Surface treatment of linings in existing buildings is not, in general, a suitable method of achieving Class B - s3, d2 (I.S. EN 13501-1) or Class 0 (BS 476) performance (see A 10 of [Appendix A](#)).

However, in the case of existing lining materials, which satisfy the assessment criteria indicated below, surface treatment to achieve the required performance may be considered. The assessment criteria are:

- the performance of the lining materials in accordance with the criteria indicated in paragraphs A6 to A10 of [Appendix A](#); and
- the extent and thickness of the lining materials; and
- the likely interaction between wall and ceiling linings; and
- the extent of voids behind the lining materials and the existence of electrical services in such voids.

Care should be taken to ensure that any products which are used to treat lining materials for the purpose of inhibiting spread of flame are applied strictly in accordance with the specification applicable to the relevant test certification supplied by the manufacturer of such products.

7.3 Internal Fire Spread (Structure)

The internal fire spread (structure) in existing buildings should meet the performance as specified under Section 3. It may be classified in accordance with I.S. EN 13501-2 or BS 476: 20 - 22 (see [Para 7.0.3.2](#)).

7.3.1 Works to Existing Buildings

Where a building, or an extension has been built, or a Material Change of Use has taken place since 1 June 1992, the provisions of the TGD B should be followed when works, including a material alteration, are proposed.

Where a building has existed since before 1 June 1992, and it has not been the subject of a material change of use since 1 June 1992, material alterations, to such a building may be carried out in accordance with any relevant guide published by the NDFEM for the purpose of providing guidance in relation to satisfying obligations under section 18(2) of the Fire Services Acts, 1981 and 2003.

7.3.2 Compartment Floors in Existing Residential (care facility) Buildings

Provisions relating to the reaction-to-fire classification of compartment floors in residential (care facility) buildings are specified under [Para 3.5.2](#).

An exception to the requirement for compartment floors to have the reaction-to-fire classification specified under [Para 3.5.2](#) may be made in the case of a material alteration of an existing residential (care facility) building.

This exception does not apply to the material change of use of a building, where a residential (care facility) building becomes so used.

7.3.3 Compartment Floors in Existing Buildings > 11 m

Provisions relating to the reaction-to-fire classification of compartment floors in buildings > 11 m are specified under [Para 3.5.4](#).

In buildings other than residential (care facility) buildings (Purpose Group 2(a)(ii)) (see [Para 3.5.2](#), [Para 7.3.2](#)) a reaction-to-fire classification of less than A2-s3, d2 may be acceptable for existing floors in an existing building, provided that fire resistance performance requirements, set out under Appendix A are met.

Section 7: Existing Buildings

7.3.4 Fire Resistance of Timber Floors in Existing Buildings

The following paragraphs provide guidance on how to provide the necessary fire resistance in an existing timber floor (see [Para 7.3.2](#), [Para 7.3.3](#)).

The techniques generally adopted to upgrade the fire resistance of timber floors are as follows:

- (a) The provision of a fire-resisting layer, or layers, beneath the existing floor joists. There are many techniques and materials available for such purposes. In some cases, it is also necessary to provide a protective layer on top of the existing floorboards or between the floor joists.
- (b) The provision of a suitable fire-resisting material in the voids between the existing floor surface and the ceiling below, or where there is no ceiling, between the floor joists. There are a number of proprietary systems available which are based on this method. These are often more appropriate than the method outlined at (a) above in buildings of historic or architectural interest, where existing plasterwork is to be retained.

Many of the techniques employed in upgrading timber floors involve the use of proprietary materials and systems. These must be capable of achieving the required performance in the situations for which they are adopted. Particular care and attention to detail in the execution of any such upgrading works is necessary to ensure the required performance.

Table 14 of the Building Research Establishment report - *Guidelines for the Construction of Fire-Resisting Structural Elements* (BR 128) provides guidance in relation to the construction of fire-resisting timber floors.

Guidance on upgrading the fire resistance of existing timber floors is provided in Building Research Digest, number 208, and BS 5268 - Part 4 - Structural use of timber - Fire resistance of timber structures - Recommendations for calculating fire resistance of timber stud walls and joisted floor constructions.

7.3.5 Compartment Walls in Existing Buildings > 11 m

Provisions relating to the reaction-to-fire classification of compartment walls in buildings with a topmost floor height > 11 m are specified under [Para 3.5.5](#).

An exception to the requirement for compartment walls to have the reaction-to-fire classification specified under [Para 3.5.5](#) may be made in the case of a material alteration or a material change of use of an existing wall in an existing building used for any purpose.

This exception does not apply to a residential (care facility) building, Purpose Group 2(a)).

Section 7: Existing Buildings

7.3.6 Doors in separating walls

In an existing building, where a door has previously been provided in a separating wall to provide a means of escape, such a door may be retained, only where there is no proven practicable alternate option for an alternative means of escape. Such a door should meet the requirements of [Appendix B](#).

7.3.7 External Cavity Walls

7.3.7.1 Material Alteration or a Material Change of Use

In existing buildings, with an external cavity wall where a material alteration or a Material change of use takes place, external cavity walls should either:

- (a) conform to the provisions of [Para 3.6.2](#), [Table 16](#) and [Diagram 53](#); or
- (b) comply with the following (see [Diagram 83](#)).
 - (i) Walls should be composed of two leafs of minimum 75 mm masonry; and
 - (ii) Combustible material should not be placed in or exposed to the cavity except for:
 - I timber lintel, window or door frame, or end of timber joists; or
 - II pipe, conduit or cable; or
 - III DPC, flashing closer or wall tie; or
 - IV domestic meter cupboard provided that:
 - A there are not more than two cupboards to a dwelling; and
 - B the opening in the outer wall leaf is not more than 0.8 m x 0.5 m for each cupboard, and
 - C the inner leaf is not penetrated except by a sleeve not more than 80 mm x 80 mm which is fire-stopped; or
 - V thermal insulating material; or
 - VI membranes (air tightness / breather membranes / DPC / DPM); and
 - (iii) All cavities are closed at:
 - I The top of the wall unless the wall is totally filled with insulation, and
 - II Openings, with closers at the head, cill and jambs of each opening.

7.3.8 Maximum Dimension of Cavities

The linings in existing buildings should meet the performance as specified under [Para 3.6.3](#). They may be classified in accordance with I.S. EN 13501-1 or BS 476 (see [Para 7.0.3.1](#)).

The maximum dimensions of concealed spaces, as outlined under [Table 17](#) do not apply to any cavity formed by over-cladding an existing concrete roof, provided that the cavity does not contain combustible insulation.

Section 7: Existing Buildings

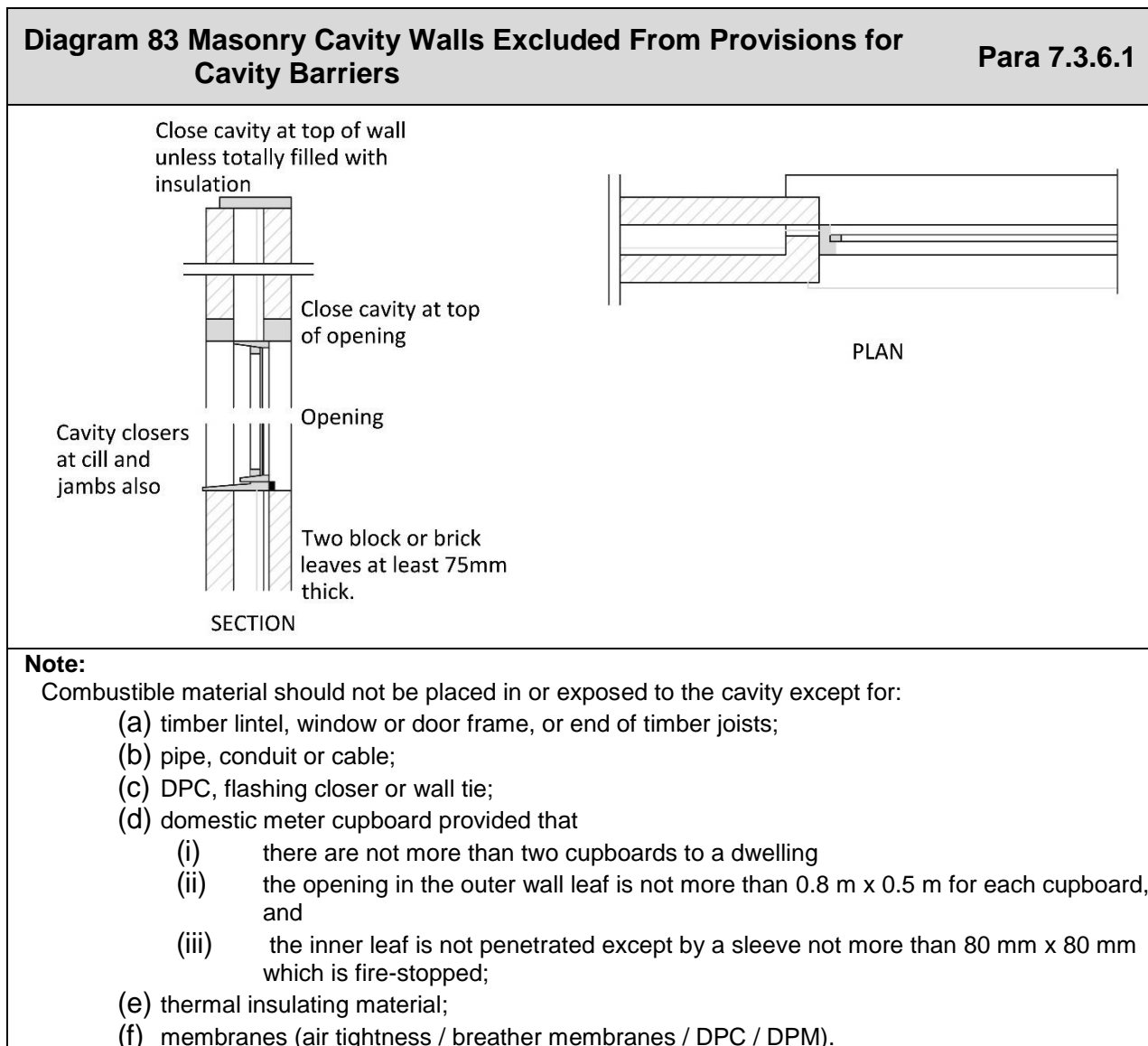

7.3.9 Openings for Pipes

Openings for pipes should comply with the provisions of [Para 3.7.2](#).

7.3.9.1 Existing above ground drainage systems

For existing buildings, where Option B of [Para 3.7.2](#) is utilised, and the pipes are composed of lead, aluminium or aluminium alloy, fibre-cement or PVC-u, the internal diameter may be a maximum of 160 mm for stack pipes, or 110 mm for branch pipes where either type of pipe passes through a compartment wall or compartment floor of a flat. Where such pipes are above ground, they should be enclosed in accordance with [Para 7.3.8.1](#) and [Diagram 84](#).

PVC-u pipes should comply with BS 4514, BS 5255, or I.S. EN 1329-1.

Diagram 84 Enclosures for Drainage or Water Supply Pipes

Para 7.3.8

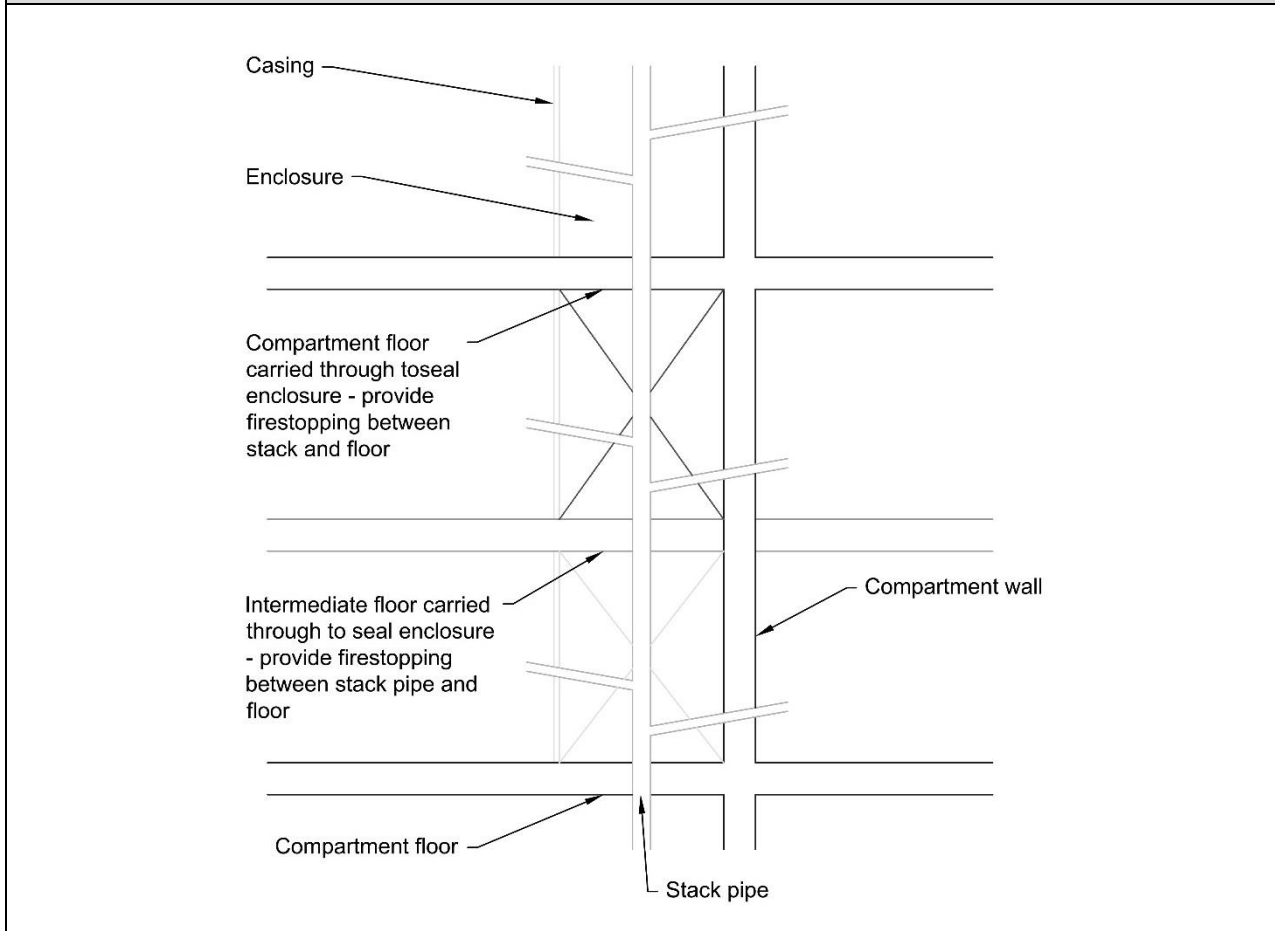

7.3.9.2 Enclosure of an Existing Above Ground Drainage System

An existing above ground drainage system should conform to the following:

- (a) the enclosure should:
 - (i) be bounded by a separating wall, a compartment wall or floor, an outside wall, an intermediate floor, or a casing (see specification at 2 below), and
 - (ii) have internal surfaces (except framing members) of Class B-s3, d2 or Class 0, and
 - (iii) not have an access panel which opens into a circulation space or a bedroom, and
 - (iv) be used only for drainage, water supply or vent pipes; and
- (b) the casing should:
 - (i) be imperforate except for an opening for a pipe or an access panel, and
 - (ii) not be of sheet metal, and
 - (iii) have not less than 30-minute fire resistance, including any access panel.

The opening for a pipe, either in the structure or the casing, should be as small as possible and firestopped around the pipe.

Section 7: Existing Buildings

7.4 External Fire Spread

7.4.1 External Walls Fire Spread

7.4.1.1 Material Alteration and Material Change of Use

In the case of a material alteration or a material change of use of an existing building, any new materials / construction added to the outermost face of the external wall, with the exceptions specified in [Para 4.3.3.3](#), should meet the performance as specified in [Para 4.3.3](#).

7.4.1.2 Elements Fixed to the External Wall of the Building

Where new elements are fixed to the external wall of an existing building with a topmost floor > 15 m (such as an open balcony, a device for reducing heat gain, a solar panel, materials which support and contain growing media in a green wall, etc.), these elements should meet the provisions as specified in [Table 19](#).

7.4.2 Portal Frames

Provisions relating to portal frames are specified under [Para 4.3.5](#).

Existing buildings which have been designed to the following guidance are acceptable:

- (a) The column members are fixed rigidly to a base of sufficient size and depth to resist overturning;
- (b) there is brick, block or concrete protection to the columns up to a protected ring beam providing lateral support; and
- (c) there is some form of roof venting to give early heat release. (The roof venting could be, for example, PVC rooflights covering 10% of the floor area and evenly spaced over the floor area.)

7.4.3 Space Separation

7.4.3.1 Material Alteration of Existing Buildings

Provisions relating to space separation are specified under [Subsection 4.4](#).

In the case of a material alteration of an existing building, the requirements in relation to space separation may be met where:

- (a) there is no increase in the extent of unprotected areas to the existing external walls of the building; and
- (b) the building is not altered or extended by the provision of additional floor area(s).

Section 7: Existing Buildings

7.4.3.1.1 Materials Added to the Façade of an Existing Building

Where material is added to the external face of the building (e.g. a cladding system), consideration should be given to:

- (a) the added material's impact on the relevant boundary and its impact on required performance of the façade (see [Para 4.4.3.1](#)), and
- (b) the potential increase in unprotected area (see [Para 4.4.6.1](#)).

7.4.3.2 Material Change of Use of Existing Buildings

Provisions relating to space separation are specified under [Subsection 4.4](#).

In the case of a material change of use of an existing building, the requirements in relation to space separation may be met where:

- (a) there is no increase in the extent of unprotected areas to the existing external walls of the building; and
- (b) the building is not altered or extended by the provision of additional floor area(s); and
- (c) a building referred to in column (b) of [Table 21](#) does not become a building referred to in column (a) of [Table 21](#).

Where any of the above criteria are not met, it will be necessary to demonstrate that the unprotected areas comply with the requirements outlined at [Para 4.4.4](#), [Para 4.4.5](#) and [Para 4.4.6](#).

Where the necessary space separation cannot be achieved, appropriate compensating measures (see [Para 7.0.2](#)) may be applied. Such measures may include:

- the provision of fire-resisting glazing,
- the provision of fire shutters,
- the provision of drencher systems,
- the provision of sprinkler systems (see [Section 8](#)), or
- any other solution which meets the equivalent required fire performance of the wall.

For buildings which are fitted throughout with an appropriate automatic sprinkler system in accordance with [Section 8](#), the following may be permitted:

- The extent of unprotected area may be doubled, or
- the distance to the boundary as specified in of [Table 21](#) may be halved.

7.4.4 Roof Coverings

Provisions relating to roof coverings are specified under [Subsection 4.5](#).

The performance specified under [Table 22](#) for limitation on roof coverings should be complied with. For existing buildings, the roof may be classified in accordance with I.S. EN 13501-5 or BS 476-3 (see [Para 7.0.3.3](#)).

Section 7: Existing Buildings

7.4.4.1 Solar Panels on Roofs

When a solar panel is placed on an existing roof, the roof beneath the panel, and the area of roof within 1m of the panel, measured in line with the pitch of the roof, should achieve a minimum Class B_{ROOF(t4)} or AA, AB, or AC designation, irrespective of the distance to the relevant boundary.

7.5 Access and Facilities for the Fire Service

Provisions relating to access and facilities for the fire service are specified under Section 5

7.5.1 Material Alteration

In the case of a material alteration of an existing building, the requirements of Section 5 may be met:

- (a) if the access and facilities for the fire service are not altered in such a way as to reduce the extent or performance of those that existed before the material alteration; or
- (b) if the building is not
 - (i) extended, or
 - (ii) altered by the provision of additional floor area at any level, or
 - (iii) the subject of a material change of use.

If the above criteria are not met, the requirements of [Section 5](#), and [Para 7.5.3](#) should be met.

7.5.2 Material Change of Use

In the case of a material change of use of a building, it will be necessary to assess the access and facilities for the fire services in accordance with [Section 5](#).

However, in relation to vehicle access, special provisions are made for existing buildings (see [Para 7.5.3](#)).

7.5.3 Access for Fire Appliances

In the case of existing buildings, where access for fire appliances is not in accordance with the provisions outlined at [Para 5.4.2](#), it is appropriate to consider a range of compensating measures, depending on the circumstances of each particular case, as follows:

- (a) In the case of an existing small building, with a total floor area of up to 1,000 m² where the height of the top storey is 11 m or below, access for fire service pump appliances should generally be provided to within 45 m of the fire service access to the building; or
- (b) In the case of a building with more than one storey, with a total floor area >1000 m², or with a topmost storey height of > 11 m, but < 20 m, the provisions of [Para 5.4.2.1](#) should be adhered to.

Section 7: Existing Buildings

7.5.4 Personnel Access to Buildings

Provisions for firefighting shafts are specified under [Para 5.5.5](#).

In an existing building, where it is not practicable for the firefighting lift to be installed in the firefighting lobby, it may be installed in the firefighting stairwell enclosure (see [Diagram 85](#)), provided that the following provisions are met:

- The building is the subject of a material change of use, or the building is extended by the provision of additional floors; and
- The firefighting lift is sited so that the movement of fire service personnel between the lift and the lobby does not impede the use of the stair by the building occupants during an evacuation; and
- The building is designed for total (simultaneous) evacuation.

If the firefighting lift is installed in the firefighting stair enclosure, the firefighting shaft should not extend below ground level.

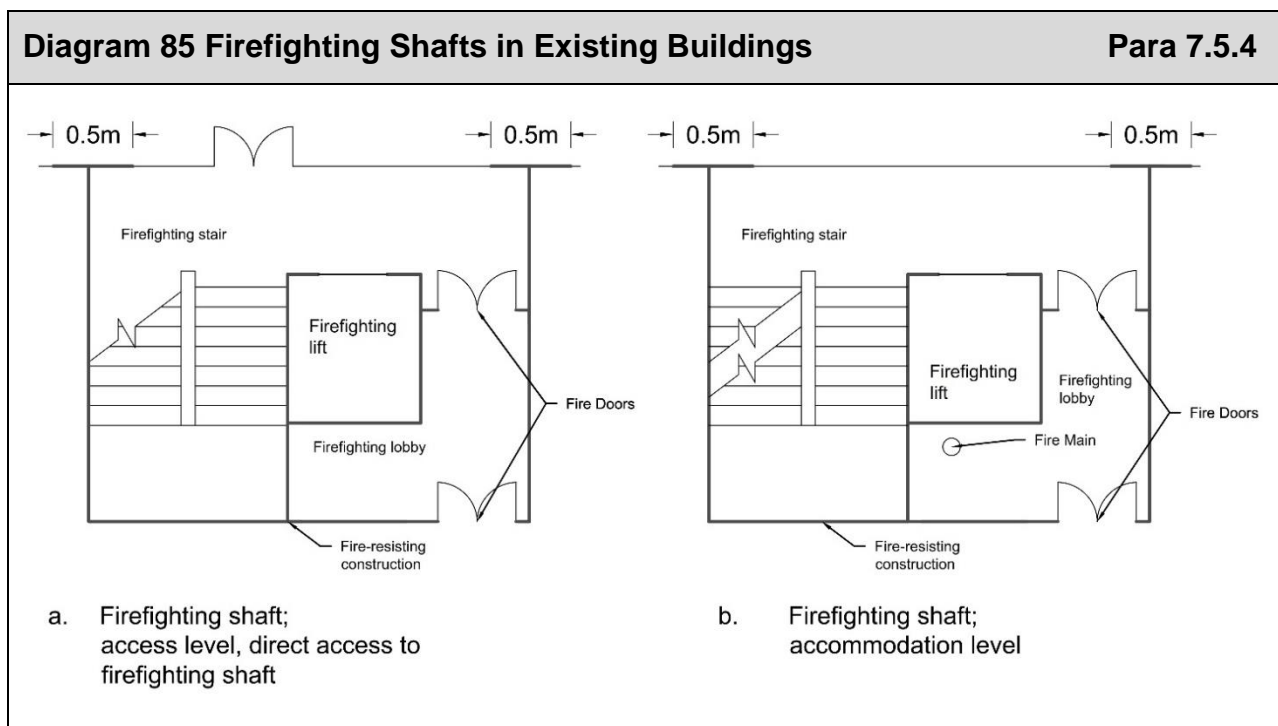

7.5.5 Fire mains in existing buildings

Under Para 5.3.2 an internal fire main is required in any building with a sleeping risk and a topmost floor height > 11m, but < 20 m. In the case of an existing building, this provision applies to a building with > 5 storeys, but with a topmost floor height of < 20 m. For such buildings with a topmost floor height > 20 m, a firefighting shaft (see Para 5.5.5) should be provided. Such a building should meet the requirements of Para 5.4.2.

7.6 Smoke Control Systems

Provisions relating to smoke control systems are specified under [Section 6](#).

7.6.1 Ventilation of Protected Stairways

In an existing building, where a material change of use takes place, every protected stairway enclosure should be provided with:

- (a) an automatic openable vent (AOV) having a clear openable area of not less than 1 m² situated at the top of the enclosure; or
- (b) automatic opening windows at each upper storey or landing.

The vent / windows should be automatically opened by activation of smoke detectors in the stairway enclosure and should also be manually openable for fire brigade use.

Private stairways, e.g. in a maisonette, are not required to be ventilated.

7.6.2 Ventilation from Basements

Provisions for ventilation of basements are specified under [Subsection 6.5](#).

Generally, smoke vents from basements should be permanently open and unobstructed, but where they are readily accessible from the outside, consideration can be given to removable covers. Smoke vents should not be positioned where they would prevent the use of the means of escape from the building.

Section 8: Sprinkler Systems

Section 8 Sprinklers

8.1 Sprinkler Systems

Sprinkler systems may assist in achieving the objectives set out in Part B of the Building Regulations. Such systems installed in buildings can reduce the risk to life and control the growth or development of fire in a building.

[Subsection 8.2](#) specifies the particular building uses and circumstances where sprinklers should be provided.

[Subsection 8.3](#) identifies other provisions of this document, where sprinklers may be required, as set out in Sections 1 to 7, owing to specific building characteristics.

Where a system is provided, the sprinkler system should be designed in accordance with the provisions set out under [Subsection 8.4](#).

8.2 Provision for Sprinkler Systems.

8.2.1 Buildings Containing Flats

A sprinkler system should be provided in any building containing flats (Purpose Group 1(c)) with a topmost floor height > 15 m. Such a system should be designed and installed in accordance with [Para 8.4.1](#).

8.2.2 Residential (Care Facility) Buildings

An automatic sprinkler system should be provided throughout a residential (care facility) building where the building has bed spaces on any level other than the ground level. Such a system should be designed and installed in accordance with [Para 8.4.2](#).

8.2.2.1 Extensions to Buildings

In the case of an extension to an existing building, an automatic sprinkler system should be provided, within the extension, where:

- (a) the existing building is sprinklered; or
- (b) the extension exceeds 400 m², or otherwise exceeds ¼ of the floor area of the existing building, and bed spaces are to be provided on any level other than the ground level.

8.2.2.2 Exempted Areas

There may be areas within a residential (care facility) building that are exempt from the need for sprinklers installed in accordance with Para 8.4.2, as follows:

- (a) Any part provided with a suitable alternative fixed fire-suppression system; or
- (b) Any part for which an automatic sprinkler system is inappropriate (in which case that area should be provided with an alternative fixed fire-protection system).

Section 8: Sprinkler Systems

8.2.3 Student Accommodation Units

A sprinkler system should be provided in any student accommodation unit (Purpose Group 2(b)) with a topmost floor height > 15 m. Such a system should be designed and installed in accordance with [Para 8.4.3](#).

8.2.4 Shopping Centres

A sprinkler system should be provided throughout any covered shopping centre. However, there may be areas within the shopping centre that are exempt from the need for sprinklers. Among these areas are:

- (a) Any mall where there are no combustibles present. (However, where an area of the mall is designed for other purposes, such as kiosk sales, displays, food courts, sprinkler protection should be provided to this area. In this situation the position and height of the sprinkler heads needs careful consideration to ensure that they provide the desired protection); or
- (b) Any part provided with a suitable alternative fixed fire suppression system; or
- (c) Any part that comprises a separate occupancy and is used for a purpose for which an automatic sprinkler system is inappropriate (in which case it should be provided with an alternative fixed fire protection system); or
- (d) Other occupancies/main uses which are part of the centre as a whole but which are totally fire-separated, which do not share the means of escape, and which meet the relevant provisions for the relevant purpose group as set out in this document.

Any fires which originate in any unsprinklered portion of a shopping centre may seriously jeopardise the efficacy of fire protection in any adjacent sprinklered zone. Consequently, careful consideration needs to be given to any potential fire load before omitting sprinklers from any part of the shopping centre.

The design of the sprinkler system should be in accordance with [Para 8.4.4](#).

8.2.5 Sprinkler Systems to Separated Stages

A sprinkler system should be installed where a separated stage (see [Para 1.4.8](#)) is provided. It should cover the stage area of a separated stage, dressing rooms, scene docks, other store rooms and workshops.

The sprinkler system should be designed in accordance with [Para 8.4.4](#).

8.2.6 Other Buildings (Uses) with a topmost floor height > 30 m

A sprinkler system should be provided throughout any office (Purpose Group 3), shop (Purpose Group 4(a)), assembly and recreation (Purpose Group 5(a)), day centre (Purpose Group 5(b)), industrial (Purpose group 6(a) or 6(b)), storage (Purpose Group 7 (a), or 7(b)), car park (Purpose Group 7(c)) or other non-residential (Purpose Group 8 building, with a topmost floor height of > 30 m (see Appendix A, [Table 32](#)).

The design of the sprinkler system should be in accordance with [Para 8.4.4](#).

Section 8: Sprinkler Systems

8.3 References to sprinkler systems

Sprinklers are specified throughout Sections 1 – 7, for a variety of use, or development-specific circumstances. For reference, citations for the application of sprinklers, are listed below.

- [Para 1.2.1](#): Hospitals (Purpose Group 2(a)(i)).
- [Para 1.4.5.3](#): Care Facilities - designing for Progressive Horizontal Evacuation.
- [Para 1.4.5.6](#): Care Facilities - bedrooms
- [Para 1.5.5.2](#): Discounting of stairways
- [Para 1.5.5.4](#): Buildings designed for phased evacuation.
- [Para 1.6.2.3.5 \(d\)](#): open plan flats.
- [Para 1.6.3.2\(d\)](#): Maisonettes.
- [Para 1.6.6.3.2 \(b\)](#): Extended single direction of travel in common protected corridors.
- [Para 3.4.4.5](#), [Table 15](#): Compartmentation.
- [Para 3.4.4.7.1](#): Ancillary accommodation.
- [Para 3.5.10](#): Junction of a compartment floor with an external wall.
- [Para 3.5.11](#): Junction of a compartment wall with an external wall
- [Para 3.8.3.3](#): Atria in residential (care facility) buildings.
- [Para 3.8.3.4](#): Atria in residential (other) buildings.
- [Para 3.8.3.5](#): Atria in shops, assembly and recreation buildings, and other non-residential buildings
- [Para 3.8.3.6](#): Atria in offices
- [Para 4.4.6.1](#): Methods of calculating acceptable unprotected areas
- [Para 4.4.7](#): Atria
- [Para 5.4.2.2](#): Buildings that cannot achieve Table 25
- [Para 5.5.2.2](#): Basements < 10 m with 2 or more floors > 900 m²
- [Para 5.5.4](#): Buildings with a topmost floor > 11 m, but < 20 m.
- [Para 5.5.6](#): Provision and number of firefighting shafts.
- [Para 6.4.2](#): Section 6 - Smoke clearance systems.
- [Para 6.4.4.1](#): Section 6 - design provisions for pressure differential systems.
- [Subsection 6.5](#): Section 6 - basements.

Section 8: Sprinkler Systems

- [Para 7.1.4.3](#): Existing buildings - maisonettes accessed directly from the outside.
- [Para 7.4.3.2](#): Existing Buildings – external fire spread - material change of use.

8.4 Design of Sprinkler Systems

Where sprinkler systems are provided, they should be designed and installed in accordance with the following paragraphs, depending on the use of the building.

Where a sprinkler system is installed, it should be designed to ensure its continued effectiveness during maintenance periods.

8.4.1 Buildings Containing Flats (Purpose Group 1(c))

For buildings containing flats, where a sprinkler system is provided, it should be in accordance with

- (a) BS 9251; or
- (b) I.S. EN 16925, only if the building has a topmost floor height less than 18 m; or
- (c) an equivalent sprinkler system.

The system should have the following as minimum requirements:

- (a) a minimum duration of operation of:
 - (i) 30 minutes for buildings with a topmost floor height of 30 m; and
 - (ii) 60 minutes for buildings with a topmost floor height of 60 m; and
- (b) a flow rate of 4 mm/min for single head operation, or 2.8 mm/min through each sprinkler operating simultaneously up to a maximum of two sprinklers in a single area of operation; and
- (c) a primary and an alternative power supply; and
- (d) a duty and standby pump; and
- (e) an on-site water storage capacity, suitable to meet the flow requirements and duration of the system, but not less than:
 - (i) 3 m³ for systems with a 30-minute duration, and
 - (ii) 6 m³ for systems with a 60-minute duration.

An isolation valve should be provided to each individual flat. It should be located within the flat, near to the main entrance door, and should be readily accessible.

In a building containing flats, the sprinkler system does not need to be provided in common protected corridors / lobbies or stairways.

Section 8: Sprinkler Systems

8.4.2 Residential (care facility) (Purpose Group 2(a) (ii))

For residential (care facility) buildings, excluding hospitals, where a sprinkler system is provided, it should be in accordance with:

- (a) BS 9251; or
- (b) I.S. EN 16925, only if the building has a topmost floor height less than 18 m; or
- (c) an equivalent sprinkler system.

The system should have the following as minimum requirements:

- (i) a minimum duration of operation of 60 minutes; and
- (ii) a flow rate of 4 mm/min for single-head operation, or 2.8 mm/min through each sprinkler operating simultaneously up to a maximum of four sprinklers in a single area of operation; and
- (iii) a primary and an alternative power supply; and
- (iv) a duty and standby pump; and
- (v) an on-site water storage capacity suitable to meet the flow requirements and duration of the system, but not less than 6 m³.

8.4.3 Residential (Other) Buildings (Purpose Group 2(b))

For residential (other) buildings, where a sprinkler system is provided, it should be in accordance with:

- (a) BS 9251; or
- (b) I.S. EN 16925, only if the building has a topmost floor height less than 18m; or
- (c) an equivalent sprinkler system.

The system should have the following as minimum requirements:

- (i) a minimum duration of operation of 30 minutes; and
- (ii) a flow rate of 4 mm/min for single head operation, or 2.8 mm/min through each sprinkler operating simultaneously up to a maximum of two sprinklers in a single area of operation; and
- (iii) a primary and an alternative power supply; and
- (iv) a duty and standby pump; and
- (v) an on-site water storage capacity suitable to meet the flow requirements and duration of the system, but not less than 3 m³.

Section 8: Sprinkler Systems

8.4.4 All Other Purpose Groups (Excluding Hospitals)

For all other purpose groups, where a sprinkler system is provided, it should be designed and installed in accordance with the provisions of I.S. EN 12845, or an equivalent sprinkler system, incorporating the relevant hazard classification together with additional measures to improve system reliability and availability as appropriate to a life safety system. The appropriate water supplies should be in accordance with the following sections of I.S. EN 12845:

- (a) Section 9.3: Storage tanks; or
- (b) Section 9.4: Inexhaustible sources; or
- (c) Section 9.5: Pressure tanks.

Direct supply of the sprinkler system by town mains is not appropriate.

In addition to the provisions specified in I.S. EN 12845, the sprinkler system should also be provided with:

- (i) a primary and an alternative power supply, and
- (ii) a duty and standby pump, where a pump is being provided.

Appendix A

Appendix A

A1 Introduction

Many of the provisions in this document are given in terms of performance in relation to standard methods of tests identified below. In such cases, the material, product, system or structure should:

- (a) be shown by test, carried out by an accredited laboratory, to be capable of meeting that performance; or
- (b) where tables of notional performance are included in this document, conform with an appropriate specification given in these tables; or
- (c) be designed, using relevant design standards, in order to meet that performance classification (see A11); or
- (d) be assessed, analysed and appraised, by applying relevant test evidence, as meeting that performance, in accordance with the following:
 - (i) Laboratories accredited for conducting the relevant test, other approved bodies, or competent persons, should carry out such assessment, analysis or appraisal.
 - (ii) Assessments should only be carried out where sufficient relevant test evidence is available. Relevant test evidence should be to the same test standard. Assessments should not be regarded as a way to avoid a test where one is necessary.
 - (iii) Where it is proposed to assess the classification of a product or system in lieu of carrying out a specific test, this should be done in accordance with the relevant standard for extended application for the test in question and should include details of the test evidence that has been used to support the assessment. For performance classifications where there is no specific standard for extended application, assessment reports should be produced in accordance with the principles of I.S. EN 15725 and should include details of the test evidence that has been used to support the assessment.

Where Harmonised standards or European Technical Assessments (ETA's) are available, reference may be made to the full list of designated Notified Bodies (including notified laboratories), for construction products, which may be found on the New Approach Notified and Designated Organisations (NANDO) Information System hosted by the European Commission.

For materials/products where European standards or assessments are not yet available and for a transition period after they become available, National Standards may continue to be used.

Where existing buildings are being assessed, they may conform to an appropriate specification given in Part II of the Building Research Establishments' Report (BR 128) *Guidelines for the Construction of Fire-Resisting Structural Elements*.

A2 Fire Tests

Building Regulations deal with fire safety in buildings as a whole, and they are aimed at limiting fire hazard.

The aim of standard fire tests is to measure or assess the response of a material, product, structure or system to one or more aspects of fire behaviour. Standard fire tests do not directly measure fire hazard. They measure or assess the response of a material or system to exposure to one or more aspects of fire conditions. Performance in fire tests is only one of a number of factors that should be taken into account.

A3 Fire Resistance

Factors having a bearing on the fire-resistance performance that is required, as specified in this document, are

- (a) fire severity; and
- (b) building height, or depth; and
- (c) building occupancy.

The standards of fire resistance given are based on assumptions about the severity of fires, and about the consequences, should an element fail. Fire severity is estimated in very broad terms from the use of the building (its Purpose Group), on the assumption that the building contents (which constitute the fire load) are the same for buildings in the same use. In the simplest terms, the concentration of combustible material indicates the maximum temperature to which construction elements may be heated.

Minimum standards for fire resistance have been devised based on estimates of the amount of combustible material per unit of floor area (termed “fire load density”) in various types of building which were made for Fire Grading of Buildings (Post-War Building Studies, No. 20). These basic standards have been modified according to particular features of the building affecting the risk to life, which are:

- (i) height of the top floor above ground, which affects ease of escape, the conditions in which firefighters have to operate and the consequences, should large-scale collapse occur; and
- (ii) occupancy, which reflects the ease with which the building can be evacuated quickly; and
- (iii) basements, where the lack of an external wall through which to vent heat and smoke may increase heat build-up while also complicating firefighting, thereby prolonging the fire; and
- (iv) single-storey construction, where escape is direct and structural failure is unlikely to precede evacuation.

Appendix A

A4 Fire-Resistance Performance

Performance in terms of the fire resistance to be met by elements of structure, doors and other forms of construction is determined by reference to:

- (a) I.S. EN 13501-2: Fire classification of construction products and building elements, Part 2 - Classification using data from fire resistance tests (excluding products for use in ventilation systems);
- (b) I.S. EN 13501-3: Fire classification of construction products and building elements, Part 3 - Classification using data from fire resistance tests on components of normal building service installations (other than smoke control systems); and
- (c) I.S. EN 13501-4: Fire classification of construction products and building elements, Part 4 - Classification using data from fire resistance tests on smoke control systems.

For existing buildings, performance in terms of the fire resistance to be met by elements of structure, doors and other forms of construction may be determined by either (a) – (c) above, or by reference to BS 476: Parts 20-24: 1987

[Table 31](#) gives the specific requirements for each element in terms of the three following performance criteria (Provisions for fire doors are set out in [Appendix B, Table 36](#)):

Load-bearing capacity (denoted **(R)**) the proven ability of a load-bearing element to resist collapse in accordance with the European classification of fire resistance performance;

Integrity (denoted **(E)**) is the proven ability of a fire-separating element to resist fire, smoke and hot-gases penetration, in accordance with the European classification of resistance performance; and

Insulation (denoted **(I)**) is the proven ability of a fire-separating element to the resistance to the transfer of excessive heat, in accordance with the European classification of fire resistance performance.

Fire resistance tests carried out by an independent third party accredited to carry out such tests offers a way of ensuring that such certification can be relied upon.

A4 (1) Minimum Periods of Fire Resistance for Elements of Structure

[Table 32](#) sets out the minimum periods of fire resistance for elements of structure. Other elements may be required to have the same fire resistance in the following cases:

- (a) Where one element of structure supports or carries or gives stability to another, the fire resistance of the supporting element should be no less than the minimum period of fire resistance for the other element (whether that other element is load-bearing or not).

Where an element of structure is required to be composed of materials with a given reaction-to-fire classification, the supporting or stabilising element should be constructed of materials with an equal or better reaction-to-fire classification.

There are circumstances where it may be reasonable to vary this principle, for example where the supporting structure is in the open air and is not likely to be affected by the fire in the building.

- (b) Where an element of structure forms part of more than one building or compartment, that element should be constructed to the standard of the greater of the relevant provisions.
- (c) Where one side of a basement (due to the slope of the ground) is open at ground level, giving an opportunity for smoke venting and access for firefighting, it may be appropriate to adopt, for elements of structure in that storey, the standard of fire resistance applicable to an above-ground structure.

[Table 33](#) sets out criteria appropriate to those suspended ceilings that can be accepted as contributing to the fire resistance of a floor.

[Table 34](#) and [Table 37](#) sets out limitations on the use of uninsulated fire-resisting glazed elements.

Any construction/element claiming to meet the relevant performance should be classified in accordance with the I.S. EN 13501 suite. The documentation used to substantiate the fire-resistance rating of a construction should be carefully checked to ensure that it is suitable, adequate and applicable to the construction to be used. Small differences in detail (such as fixing method, joints, dimensions, etc.) may significantly affect the rating.

Fire-resisting elements of construction should be strictly in accordance with the specification and method of construction which, by the criteria indicated at A1, can be shown to be capable of meeting the required performance.

To ensure that the continuity of fire resistance is maintained, care and attention to detail should be taken at:

- (i) the junctions between fire-resisting elements of construction; and
- (ii) any penetrations of a fire resisting element.

Appendix A

A5 Roof Coverings

Performance of the resistance of roofs to external fire exposure is measured in terms of penetration through the roof construction and the spread of flame over its surface.

All constructions are classified in accordance with I.S. EN 13501-5. I.S. EN 13501-5 refers to four separate roof tests. The suffix (t4) indicates that Test 4 is to be used for the purposes of this document.

The standard classifies products as B_{ROOF}(t4), C_{ROOF}(t4), D_{ROOF}(t4), E_{ROOF}(t4) or F_{ROOF}(t4), with B_{ROOF}(t4) being the highest performance and F_{ROOF}(t4) being the lowest.

Roof-covering products (and/or materials) can be considered to fulfil all of the requirements for the performance characteristic “external fire performance” without the need for testing if they are listed in Commission Decision 2000/553/EC of 6 September 2000 implementing Council Directive 89/106/EEC as regards the external fire performance of roof coverings.

For existing buildings, performance in terms of the fire resistance of roofs to external fire exposure may be met by either the above classifications or by reference to the national classifications (see Section 7). Roof performance is classified within the national system by 2 letters in the range A to D, with an AA designation being the best. The first letter indicates the time to penetration, and the second letter is a measure of the spread of flame.

[Table 35](#) gives notional designations of some generic roof coverings.

A6 Reaction to Fire

The reaction to fire of all products are classified in accordance with I.S. EN 13501-1. This standard classifies products, excluding floors as A1, A2, B, C, D, E or F, with class A1 being the highest performance and F being the lowest. Floors are classified as above but with an ‘fl’ suffix, e.g.: A1fl

The relevant European test methods under I.S. EN 13501-1 are:

- I.S. EN ISO 1182: Reaction to Fire Tests for Building Products - Non-Combustibility Test.
- I.S. EN ISO 1716: Reaction to Fire Tests for Products - Determination of the Gross Heat of Combustion (Calorific Value).
- I.S. EN 13823: Reaction to Fire Tests for Building Products - Building Products Excluding Floorings Exposed to the Thermal Attack by a Single Burning Item.
- I.S. EN 13238: Reaction to Fire Tests for Building Products - Conditioning Procedures and General Rules for Selection of Substrates.
- EN ISO 9239-1: Reaction to Fire Tests for Floorings - Part 1: Determination of the Burning Behaviour Using a Radiant Heat Source
- I.S. EN ISO 11925-2: Reaction to Fire Tests for Building Products, Part 2 - Ignitability of Products Subjected to Direct Impingement of a Flame.

Appendix A

The classes of reaction-to-fire performance of A2, B, C, D and E are accompanied by additional classifications related to the production of smoke (s1, s2, s3 with s1 being the highest performance) and/or flaming droplets/particles (d0, d1, d2, with d0 being the highest performance). When a classification includes “s3, d2”, it means that there is no limit set for smoke production and/or flaming droplets/particles.

Under various EU Commission Decisions, products may have a declared performance without test, or they may be tested and be assigned a declared performance. Materials covered by the Classification Without Further Testing (CWFT) process can be found by accessing the European Commission’s website <https://eur-lex.europa.eu/>.

Where a reaction-to-fire performance is specified in this document, it may be met by a material achieving a higher performance. Where Class B is specified, for example, any material achieving Class A2 or A1 will also meet this performance.

While individual products used in construction (e.g. plasterboard, timber, steel, aluminium) will have a “Reaction to Fire” designation based on tests carried out, and certified by a competent body, this does not mean that the construction has a fire resistance (see A1).

A6 (1) Linings

Flame-spread over wall or ceiling surfaces is controlled by providing for the lining materials or products to meet given performance levels in tests appropriate to the materials or products involved. Products consisting of a surface material bonded to a substrate should be tested together.

Section 2 outlines the performance to be achieved, when classified in accordance with I.S. EN 13501-1 (see A6 above), for internal wall and ceiling linings.

Section 4 outlines the performance to be achieved, when classified in accordance with I.S. EN 13501-1 (see A6 above), for external walls.

Any reference used to substantiate the surface-spread-of-flame rating of a material or product should be carefully checked to ensure that it is suitable, adequate and applicable to the construction to be used. Small differences in detail — in terms of thickness, substrate, fixings or adhesive, for example — may significantly affect the rating.

Appendix A

A7 Reaction to Fire – Existing Buildings

For existing buildings, performance in terms of the reaction to fire for wall and ceiling linings may be achieved by reference to the European system of classification (see A6 above), or by reference to BS 476, Parts 6 -7 (National classifications).

Under the national classifications, lining systems are rated for performance by reference to the method specified in BS 476: Part 7: 1971 or 1987 under which materials or products are classified 1, 2, 3 or 4 - with Class 1 being the highest (Class 4 ratings are not acceptable under the provisions in this document).

Class 0 is not a classification identified in any BS 476 standard test. This class is achieved if a material or the surface together with its substrate of a composite product is either:

- (a) composed throughout of materials of limited combustibility (see A 9); or
- (b) a Class 1 material which has a fire-propagation index (I) of not more than 12 and sub-index (I1) of not more than 6.

A7 (1) Generic Class 0 Materials

Among the generic materials and products that typically have performance ratings that achieve Class 0 are the following:

- any non-combustible material or material of limited combustibility (composite products (national) listed under A9 or A10); or
- brickwork, blockwork, concrete and ceramic tiles; or
- plasterboard (painted or not, with or without an air gap or fibrous or cellular insulating material behind); or
- wood-wool cement slabs; or
- mineral fibre tiles or sheets with cement or resin binding.

A7 (2) Generic Class 3 Materials

Among the generic materials and products that typically have performance standards that achieve Class 3 are the following:

- timber or plywood with a density of more than 400 kg/m³, (painted or unpainted); or
- wood-particle board or hardboard, (either treated or painted); or
- standard glass-reinforced polyesters.

Where composite products are in an existing building, and are defined as materials of limited combustibility (see A9), they should in addition comply with the surface rating requirements specified in Section 7.

A8 Thermoplastics

A thermoplastic material means any polymeric material which has a softening point below 200°C if tested to I.S. EN ISO 306, Method A120. Products formed from these materials cannot always be classified in the normal way. In those circumstances, the following approach can be followed.

For the purposes of Sections 2 and 4, thermoplastic materials should be classified in accordance with A6 above or be classified as TP (a) or TP (b), which have specific requirements.

Thermoplastic materials are classified as TP (a) or TP (b), as follows:

TP (a) rigid:

- (a) Rigid, solid PVC sheet; or
- (b) Solid (as distinct from double - or multiple-skin) polycarbonate sheet at least 3mm thick; or
- (c) Multi-skinned rigid sheet made from unplasticised PVC or polycarbonate which has Class 1 rating when tested to BS 476: Part 7 or Class C-s3, d2 to IS EN 13501-1; or
- (d) Any other rigid thermoplastic product, a specimen of which, when tested to BS 2782-0 Method 508A, performs so that the test flame extinguishes before the first mark, and the duration of flaming or afterglow does not exceed 5 seconds following removal of the burner.

TP (b):

- (i) Rigid, solid polycarbonate sheet products less than 3mm thick, or multiple skin polycarbonate sheet products which do not qualify as TP (a) by test; or
- (ii) Other products which, when a specimen of the material between 1.5mm and 3mm thick is tested in accordance with BS 2782-0 Method 508A, have a rate of burning which does not exceed 50 mm/minute; or
- (iii) The product, when ignited, does not produce burning droplets which could contribute to the spread of fire within a building.

If it is not possible to cut or machine a 3mm thick specimen from the product, then a 3mm test specimen can be moulded from the same material that was used for the manufacture of the product

No thermoplastic material in isolation can be assumed to protect a surface underlying it. The surface rating of both products must meet the required classification. However, if the thermoplastic material is fully bonded to a non-thermoplastic substrate, then only the surface rating of the composite will need to comply.

Appendix A

A9 Materials of Limited Combustibility (Existing Buildings)

Materials of limited combustibility are:

- (a) Any non-combustible material; or
- (b) Any material of density 300 kg/m^3 or more which when tested to BS 476: Part 11, does not flame or experience a rise in temperature on the furnace thermocouple of more than 20 degrees Celsius; or
- (c) Any material with a non-combustible core at least 8mm thick having combustible facings (on one or both sides) not more than 0.5mm thick (When a flame spread rating is specified, these materials must also meet the appropriate test requirements);
or
- (d) Any material of density less than 300 kg/m^3 , which when tested to BS 476: Part 11 does not flame for more than 10 seconds or experience a rise in temperature on the centre (specimen) thermocouple of more than 35 degrees Celsius and on the furnace thermocouple of more than 25 degrees Celsius.

A10 Non-Combustible Materials (Existing Buildings)

A non-combustible material is:

- (a) Any material which when tested to BS 476-11, does not flame and there is no rise in temperature on either the centre (specimen) or furnace thermocouples; or
- (b) Totally inorganic materials such as concrete, fired clay, ceramics, metals, plaster and masonry containing not more than 1 per cent by weight or volume of organic material (The use in buildings of combustible metals such as magnesium/aluminium alloys should be assessed in each individual case); or
- (c) Concrete bricks or blocks meeting I.S. EN 771; or
- (d) Products classified as non-combustible under BS 476-4.

Appendix A

A11 Structural Fire Design

The Eurocodes are a set of harmonised European structural design codes for building and civil engineering works and are produced by CEN (European Committee for Standardisation).

There are 10 Eurocodes made up of 58 Parts. Each Part is implemented nationally with a National Annex. These Annexes contain information on nationally determined parameters to be used for the design of building and civil engineering works to be constructed. Among the topics covered are particular national safety parameters, geographical and climatic conditions, and procedures.

Irish National choices are contained in the Irish National Annex or National Foreword to each Part. Therefore, any reference to the Eurocodes must be taken to include reference to the relevant Irish National Annex.

Attention is drawn to the fire parts of the Structural Eurocodes, which present a range of options for the designer ranging from prescriptive rules based on standard fire resistance periods and the use of tabulated data to calculation procedures based on a natural fire exposure and whole building behaviour, as follows:

I.S. EN 1990: 2002,

I.S. EN 1991-1-2: 2002,

I.S. EN 1992-1-2: 2004,

I.S. EN 1993-1-2: 2005,

I.S. EN 1994-1-2: 2005,

I.S. EN 1995-1-2: 2004,

I.S. EN 1996-1-2: 2005,

I.S. EN 1999-1-2: 2007

Guidance on fire resistance of masonry walls is included in Clause 5.8 of S.R. 325.

When assessing existing structural elements in existing buildings, guidance on the design for different structural materials is contained in Part 1 of the Building Research Establishment Report (BR 128) Guidelines for the Construction of Fire-Resisting Structural Elements, or BS 5268 Part 4 Structural use of timber - Fire resistance of timber structures - Recommendations for calculating fire resistance of timber stud walls and joisted floor constructions.

Appendix A

Table 31 Minimum Provisions of Fire Resistance Performance					
Part of building		R (1) Load-bearing capacity	E Integrity	I Insulation	Method of exposure
1	Structural frame, beam or column	*	NP	NP	Exposed faces
2	Load-bearing wall (which is not also a wall described in any of the following items)	*	NP	NP	Each side separately
3	Floors				
	(a) Intermediate floors in maisonettes	30	30	30	From underside ⁽³⁾
	(b) Any other floor including compartment floors ⁽¹⁰⁾	*	*	*	From underside ⁽³⁾
	(c) Projection of not less than 0.5m (see Para 3.5.10.)	*	*	*	From underside
	(d) Common access balcony / deck approach in buildings containing flats ⁽⁴⁾	30	30	30	From underside
4	Any roof forming part of an escape route	30	30	30	From underside ⁽³⁾
5	Any external podium forming part of an escape route	*	*	*	From underside ⁽³⁾
6	External Walls				
	(a) Any part less than 1 m from any point on relevant boundary	*	*	*	Each side separately
	(b) Any part 1 m or more from the relevant boundary	*	*	15 ⁽⁵⁾	From inside
	(c) Any part adjacent to a common open deck in a building containing flats, as described in Diagram 27 (b) ⁽⁶⁾	30	30	30	From inside
	(d) 0.9m Fire-resisting zone (see Para 3.5.10)	*(max60)	*(max 60)	*(max 60)	Each side separately
7	Separating Wall ⁽⁷⁾	*(min 60)	*(min 60)	*(min 60)	Each side separately
8	Compartment Wall	*	*	*	Each side separately
9	Fire-resisting wall described under Para 3.4.4.7	30	30	30	Each side separately
10	Protected shafts, excluding any firefighting shaft				
	(a) Any glazing described in Section 3, Para 3.5.16.3.1 and Diagram 52 ⁽⁸⁾	N/A	30	No provision	Each side separately
	(b) Any other part between the shaft and a protected lobby/corridor, as described in Diagram 52	30	30	30	Each side separately
	(c) Any part not described in (a) or (b) above	*	*	*	Each side separately

Appendix A

11	Enclosure (which does not form part of a compartment wall or a protected shaft) to a:				
	(a) Any protected stairway	30	30	30 ⁽⁸⁾	Each side separately
	(b) Lift shaft,	30	30	30	Each side separately
	(c) Service shaft	30	30	30	Each side separately
	(d) Electrical distribution board in a protected stairway	NP	30	NP	From Inside
12	Enhanced protected stairway (see Para 5.4.2.1)	60	60	60	Each side separately
13	Firefighting shafts:				
	(a) Construction separating firefighting shaft from rest of building	120	120	120	From side remote from firefighting shaft
		60	60	60	From shaft side
	(b) Construction separating firefighting stairway, firefighting lift shaft and firefighting lobby	60	60	60	Each side separately
14	Enclosure (which is not a compartment wall or described in item 10) to a				
	(a) protected lobby ⁽⁹⁾ , or	30	30	30 ⁽⁸⁾	Each side separately
	(b) protected corridor	30	30	30 ⁽⁸⁾	Each side separately
15	Subdivision of a corridor	30	30	30 ⁽⁸⁾	Each side separately
16	Enclosure to a				
	(a) protected entrance, hall, or	30	30	30 ⁽⁸⁾	Each side separately
	(b) protected stairway in a flat or maisonette	30	30	30 ⁽⁸⁾	Each side separately
17	Walls				
	(a) to ancillary accommodation in a nursing home, as described in Para 3.4.4.7.1	30	30	30	Each side separately
	(b) to ancillary accommodation, including common amenity areas, in a building containing flats, as described in Para 1.6.8	30	30	30	Each side separately
	(c) to ancillary accommodation in a shopping centre	30	30	30	Each side separately
	(d) between bedrooms in nursing homes (where required)	30	30	30	Each side separately
	(e) to a communal area in a student accommodation unit (see Para 1.4.9(i))	30	30	30	Each side separately
	(f) separating a kitchen / living room from bedrooms as per Diagram 21(c)	30	30	30	Each side separately
	(g) store room in a small premises (see Para 1.8.1)	30	30	30	Each side separately
18	Cavity barrier	NP	30	15	Each side separately
19	Ceiling described in Diagram 42 (b)	N/A	30	30	From underside

Appendix A

20	Duct described in Para 3.6.5 (e) ⁽¹⁰⁾	N/A	30	No Provision	From outside
21	Casing around a drainage system (see Para 7.3.8) ⁽¹¹⁾	N/A	30	No provision	From outside
22	Flue walls described in Para 3.7.4	°	°	°	From outside
23	Proscenium Wall	60	60	60	Each side separately
24	Compartment construction separating a public road or fire service access road from a shopping centre, if the construction is				
	(a) a floor over a basement,	240	240	240	From underside
	(b) a wall in a basement,	240	240	240	Each side separately
	(c) any floor at any other level	*	*	*	From underside
	(d) any wall at any other level	*	*	*	Each side separately
25	Enclosure to a foyer in a theatre, cinema or similar venue (see Para 1.4.3.2)	30	30	30	Each side separately
26	Fire doors	See Table 36 of Appendix B			
Notes:					
NP	No Provision				
*	Denotes the minimum period of fire resistance set out in Table 32				
°	Denotes half the minimum period of fire resistance set out in Table 32 for the compartment wall/floor				
N/A	Denotes that provision is not applicable				
1	Applies to load-bearing elements only				
2	In existing buildings classifications (of an equivalent performance) to BS 476 may be used (see A7).				
3	A suspended ceiling should only be relied on to contribute to the fire resistance of the floor if the ceiling meets the appropriate provisions given in Table 33 .				
4	A common access open deck may perform the function of a projection Item 3(c) if it meets the performance specified in 3(c).				
5	30 minutes for any part adjacent to an external escape route (but no provision for glazed elements in respect of insulation)				
6	To 1.8 m above the level of the open access deck				
7	See Section 3, Para 3.5.6 for requirements for construction of separating walls.				
8	Except for any limitations on glazed elements given in Table 34 .				
9	Including a lobby to a refuge area				
10	Ducts from commercial kitchens should have an EI rating from both sides and should have a fire resistance not less than the highest rating required for any element of construction through which they pass.				
11	The use of an enclosure of an above-ground drainage system is appropriate only in the case of a material alteration or material change of use of an existing building (see Subsection 7.3).				

Appendix A

Table 32 Minimum Periods of Fire Resistance for Elements of Structure								
Use (Purpose group) of buildings			Minimum period (minutes) for elements of structure in a:					
			basement storey (including floor over) #		ground or upper storey			
			Depth (m) of lowest basement ⁽³⁾		Height of top storey in building or separated part ⁽³⁾			
			more than 10	not more than 10	not more than 5	not more than 20	not more than 30	more than 30 ⁽⁴⁾⁽⁵⁾
1c	Flats and maisonettes		90	60	30*	60**	90**	120**
2a	Residential (care facility)		90	60	60	60	90	120∅
2b	Residential (other)		90	60	30*	60	90	120∅
3	Office	Not sprinklered	90	60	30*	60	90	X
		Sprinklered ⁽¹⁾	60	60	30*	30*	60	120∅
4a	Shop	Not Sprinklered	90	60	60	60	90	X
		Sprinklered ⁽¹⁾	60	60	30*	60	60	120∅
4b	Shopping centre		120	120	120	120	120	120
5a, 5b	Assembly and recreation, day centre	Not Sprinklered	90	60	60	60	90	X
		Sprinklered ⁽¹⁾	60	60	30*	60	60	120∅
6a, 6b	Industrial	Not Sprinklered	120	90	60	90	120	X
		Sprinklered ⁽¹⁾	90	60	30*	60	90	120∅
7a, 7b, 8	Storage, Other non- residential	Not sprinklered	120	90	60	90	120	X
		Sprinklered ⁽¹⁾	90	60	30*	60	90	120
7c	Car parks	Open sided ⁽²⁾	X	X	15*	15*	15*	X
		Other	90	60	30*	60	90	120∅
Notes								
X	Not permitted							
*	Increased to 60 minutes for separating walls							
**	Reduced to 30 minutes for any floor within a maisonette (but not if the floor contributes to the support of the building as a whole)							
∅	Reduced to 90 minutes for elements not forming part of the structural frame							
#	The floor over a basement (or if there is more than 1 basement, the floor over the topmost basement) should meet the provisions for the ground and upper storeys if that period is higher.							
(1)	"Sprinklered" means that the building is fitted with an automatic sprinkler system meeting the provisions of Section 8 .							
(2)	The car park should comply with the relevant provisions in Section 3, 3.8.2. Refer to Table 31 for specific provisions of test.							
(3)	For height of top storey or depth of basement, see Appendix C, Diagram 91 .							
(4)	Buildings with a topmost floor height > 60 m are outside the scope of this document (see Para 0.1.2).							
(5)	Buildings within Purpose Groups 3 to 7(c) require sprinklers where there is a top storey above 30m. The sprinkler system should be provided in accordance with Section 8 .							
Refer to Table 31 for specific provisions of fire-resistance test for elements of structure.								

Appendix A

Table 33 Limitations on Fire-protecting Suspended Ceilings (see [Table 31](#), Note 3)

Height of building or of separated part (m)	Type of floor	Provisions of fire resistance of floor (minutes)	Reaction to fire classification of Surface of ceiling exposed to the cavity
Less than 15	Not compartment	60 or less	Class C-s3, d2 or better
	Compartment	Less than 60	
		60	Class B-s3, d2 or better
15 or more	Any	60 or less	Class B-s3, d2 or better ^{(1) (3)}
No limit	Any	More than 60	Class A2-s3, d2 or better ^{(1)(2) (3)}

Notes:

- (1) Ceiling should not contain easily openable access panels.
- (2) Any insulation above the ceiling should be of a material of Class A2-s3, d2 or better.
- (3) Any access panels provided in the fire-protecting suspended ceilings should be secured in position by releasing devices or screw fixings, and they should be shown to have been tested in the ceiling assembly in which they are incorporated.

For existing suspended ceilings in existing buildings, performance in terms of the reaction-to-fire classification for suspended ceilings may be achieved by reference to the European system of classification (see A6 above), or by reference to BS 476, Parts 6-7 (National classifications) (see Section 7 and A7 above).

Appendix A

Table 34 Limitations on the use of Uninsulated Fire-resisting Glazed Elements in Walls on Escape Routes (see Table 31, Note 10)			
Position of glazed element		Maximum total glazed area in parts of a building with access to:	
		a single stairway	more than one stairway
1	Within the enclosures to a protected entrance hall or protected landing of a flat or maisonette	Fixed fanlights only	Fixed fanlights only
2	Between residential/sleeping accommodation and a common escape route (corridor, lobby or stairway)	No glazing	No glazing
3	*Between a protected stairway (+) and	No glazing	Unlimited above 1.1 m #
	(a) the accommodation, or		
	(b) a corridor which is not a protected corridor		
4	(5) Between*	Unlimited above 1.1 m from floor	Unlimited above 1.1 m from floor
	(a) a protected stairway (+) and a protected lobby or protected corridor		
	(b) the accommodation and a protected lobby		
5	*Between the accommodation and a protected corridor forming a dead end	Unlimited above 1.1 m from floor	Unlimited above 1.1 m from floor
6	*(a) Between the accommodation and any other corridor	N/A	Unlimited above 0.1 m from floor
	(b) Subdividing corridors		
Notes: * But not any such part included in item 2 (+) If the protected stairway is also a protected shaft (see Section 3), or a firefighting stairway (see Section 5), the use of glazed elements may be further restricted. # Measured vertically from the landing floor level or the stairway pitch line			

Appendix A

Table 35 Notional Designations of Roof Coverings				
Part I: Pitched roofs covered with slates or tiles				
	Covering material	Supporting structure	Designationⁿ	
1.	Natural slates	Timber rafters with or without underfelt, sarking, boarding, wood wool slabs, plywood, wood chipboard, or fibre insulating board	B _{ROOF} (t4)	
2.	Fibre-cement slates			
3.	Clay tiles			
4.	Concrete tiles			
Part II: Pitched roofs covered with pre-formed self-supporting sheets				
	Material	Construction	Supporting structure	Designation
	Profiled sheets of (i) galvanised steel (ii) aluminium (iii) fibre reinforced cement (iv) PVC- coated steel	single skin without underlay or with underlay of (i) plasterboard (ii) fibre insulating board (iii) wood wool slab	Structure of timber, steel or concrete	B _{ROOF} (t4)
	Profiled sheets of: (i) galvanised steel (ii) aluminium (iii) composite steel and fibre-cement (iv) fibre-cement or (v) PVC- coated steel	2. double skin without underlay or with underlay of - (i) resin-bonded glass fibre (ii) bitumen-bonded glass fibre (iii) mineral wool slab or blanket (iv) polystyrene or (v) polyurethane	Structure of timber, steel or concrete	B _{ROOF} (t4)
Part III: Pitched or flat roofs covered with fully supporting material				
	Covering Material	Supporting structure	Designation	
1.	Aluminium sheet	1. Timber joists and (i) tongued and grooved boarding, or (ii) plain edged boarding	B _{ROOF} (t4)*	
2.	Copper sheet			
3.	Zinc sheet	2. Steel or timber joists with deck of: (i) wood wool slab (ii) compressed straw slab (iii) wood or flax chipboard (iv) fibre insulating board, or (v) 9.5 mm plywood	B _{ROOF} (t4)*	
4.	Lead sheet			
5.	Mastic asphalt			
6.	Vitreous enamelled steel sheet			
7.	Lead/tin alloy coated steel sheet			
8.	Zinc/aluminium alloy coated steel sheet			
9.	Pre-painted (coil-coated) steel sheet including liquid-applied PVC coatings			
		3. Concrete or clay pot slab (cast in situ or precast), or deck composed of materials with a reaction-to-fire classification achieving A1, of steel, aluminium or fibre-cement (with or without insulation)	B _{ROOF} (t4)	
Note: *Lead sheet supported by timber joists and plain edge boarding is deemed to be designated Class C _{ROOF} (t4)				

Appendix A

Table 35 Notional Designation of Roof Coverings			
Part IV (A): Pitched roofs covered with bitumen felt			
Number of layers	Two or three layers built up in accordance with BS 8217: <i>Reinforced bitumen membranes for roofing: Code of practice</i>		
Type of upper layer	1. Type 1E	2. Type 2E	3. Type 3E
Type of under-layer(s)	Type 1B (minimum mass 13 kg/10 m ²)	Type 1B (minimum mass 13 kg/10 m ²)	Type 3B or 3G
Deck of any of the following: <ul style="list-style-type: none"> • plywood (6mm), • wood chipboard (12.5mm), • T&G boarding (16mm finished), or • plain edged boarding (19mm finished) 	D _{ROOF} (t4) (I.S. EN 13501-5) or CC (BS 476-3)	C _{ROOF} (t4) (I.S. EN 13501-5) or BB (BS 476-3)	C _{ROOF} (t4) (I.S. EN 13501-5) or BC (BS 476-3)
Deck of compressed straw slab	B _{ROOF} (t4) (I.S. EN 13501-5) or AC (BS 476-3)	B _{ROOF} (t4) (I.S. EN 13501-5) or AB (BS 476-3)	B _{ROOF} (t4) (I.S. EN 13501-5) or AC (BS 476-3)
Deck of screeded wood wool slab	B _{ROOF} (t4) (I.S. EN 13501-5) or AC (BS 476-3)	B _{ROOF} (t4) (I.S. EN 13501-5) or AB (BS 476-3)	B _{ROOF} (t4) (I.S. EN 13501-5) or AB (BS 476-3)
Fibre-cement or steel single- or double-skin deck (without overlay or with overlay of fibre insulating board)	B _{ROOF} (t4) (I.S. EN 13501-5) or AC (BS 476-3)	B _{ROOF} (t4) (I.S. EN 13501-5) or AB (BS 476-3)	B _{ROOF} (t4) (I.S. EN 13501-5) or AB (BS 476-3)
Aluminium single- or double-skin deck (without overlay or with overlay of fibre insulating board)	B _{ROOF} (t4) (I.S. EN 13501-5) or AC (BS 476-3)	B _{ROOF} (t4) (I.S. EN 13501-5) or AB (BS 476-3)	B _{ROOF} (t4) (I.S. EN 13501-5) or AB (BS 476-3)
Concrete or pot slab (cast in situ or precast)	B _{ROOF} (t4) (I.S. EN 13501-5) or AB (BS 476-3)	B _{ROOF} (t4) (I.S. EN 13501-5) or AB (BS 476-3)	B _{ROOF} (t4) (I.S. EN 13501-5) or AB (BS 476-3)
Notes:			
(1) Where bitumen products are used, the material should be tested in accordance with I.S. EN 13707, and should have a declared performance under I.S. EN 13501-5 appropriate to its use, in accordance with Table 22 .			

Table 35 Notional Designation of Roof Coverings
Part IV (B): Flat roofs covered with bitumen felt
A flat roof comprising a covering of bitumen felt shall (irrespective of the felt specification) be deemed to be of class B _{ROOF} (t4) (I.S. EN 13501-5) or AA (BS 476-3) if the felt is laid on a deck constructed of any of the materials prescribed in Table 35 (Part IV(A)) above and has a surface finish of <ol style="list-style-type: none"> bitumen-bedded stone chippings covering the whole surface to a depth of not less than 12.5 mm, bitumen-bedded tiles of a material with a reaction to fire classification achieving A1, sand and cement screed, or macadam

Appendix B Fire Doors

Appendix B: Fire Doors

B1 General

B1.1 The definition of a Fire Door is contained in [Subsection 0.10](#) (Definitions).

Any reference to a fire door in this Technical Guidance Document is intended to mean a complete door assembly. This includes the door leaf or leaves, the door frame, ironmongery (hinges, latches, closers, etc.) and any seals where required between the frame and leaf or between leaves in the case of a twin-leaf door.

The performance of a fire door critically depends on the correct installation of the complete door assembly, strictly in accordance with the terms of the relevant test certification supplied by the door manufacturer.

Attention is drawn to the importance of the junction between the structure and the doorframe and the need to provide fire-stopping to maintain required fire resistance.

All fire doors should have the appropriate performance given in [Table 36](#). This performance should be classified in accordance with I.S. EN 13501-2.

They are tested to the relevant European method from the following:

- (a) I.S. EN 1634- 1: Fire Resistance Tests for Door and Shutter assemblies, Part 1 – Fire Doors and Shutters;
- (b) I.S. EN 1634-2: Fire Resistance Tests for Door and Shutter Assemblies, Part 2 – Fire door Hardware;
- (c) I.S. EN 1634-3: Fire Resistance Tests for Door and Shutter Assemblies, Part 3 – Smoke Control Doors and Shutters.

While classification of performance of a fire doorset to I.S. EN 13501-2 is the preferred method, internal fire doorsets may continue to be tested to BS 476 Part 22. Such doorsets, when tested, should meet an equivalent performance to that out under [Table 36](#), in terms of integrity for a period of minutes, e.g. FD30. A suffix (S) is added for doorsets where restricted smoke leakage at ambient temperatures is needed.

[Table 31](#) and [Table 32](#) of [Appendix A](#) sets out the minimum periods of fire resistance for elements of structure to which the performance of some doors is linked. [Table 37](#) sets out limitations on the use of uninsulated fire-resisting glazed elements on fire doors on escape routes.

The performance requirement is in terms of integrity (E) for a period of minutes. An additional classification of Sa is used for all doors where restricted smoke leakage at ambient temperatures is needed.

Appendix B Fire Doors

A fire door should meet the performance from each side separately, except in the case of lift doors, which should meet the performance from the landing side only.

Every fire door (i.e. the complete fire door assembly) should be supported by a fire test report and assessment from an accredited laboratory (see Technical Guidance Document D), which indicates that the complete assembly will meet the required performance.

B2 Existing Buildings

B2.1 Fire door performance in existing buildings may be achieved by reference to either the European classification method (see B1), or the national classification method to BS 476-22.

B2.2 The performance achieved should be equivalent to that set out in [Table 36](#). This applies both in respect of fire resistance designated FD, and to smoke leakage designated S. Unless pressurisation techniques complying with I.S. EN 12101-6 are used, these doors should have a leakage rate not exceeding 3 m³/m/hour (head and jambs only) when tested at 25 Pa under BS 476-31-1.

B2.3 For material alterations or a material change of use in an existing building, the required performance may be met by the installation of a fire doorset, as above, or a fire door leaf or leaves in the existing frame. In such a case, the frame should be assessed by a competent person to determine its capacity to meet the required performance, taking into consideration its thickness, material and condition.

B3 Self-Closing Devices

B3.1 All fire doors should be fitted with an automatic self-closing device (tested to I.S. EN1154) which is capable of closing the door from any angle and against any latch fitted to the door.

B3.2 Fire doors to cupboards and to service ducts which are kept locked shut do not require a self-closing device.

B3.3 Where a self-closing device would be considered a hindrance to the normal use of the building, fire doors may be held open by:

- (a) A fusible link which conforms to IS EN 1155, (but not if the door is fitted in an opening provided as a means of escape unless it complies with Subsection B 3.4 below); or
- (b) An automatic release mechanism which will release the door on activation of an adjacent smoke detector on the fire alarm system, if the door can also be closed manually and it is not:
 - (i) the only escape stairway serving a building (or part of a building); or
 - (ii) a door serving a firefighting stairway; or
 - (iii) a door serving a common escape stairway in a building of any residential purpose group; or

Appendix B Fire Doors

(c) A door closure delay device, tested to I.S. EN 1154.

For a door in any other situation, a door hold-open device may be provided

B3.4 Where an area is protected by sprinklers (see [Section 8](#)), any fusible link or other heat-sensitive device designed to close a fire door or shutter within its surrounding walls should:

- (a) operate before the sprinklers; or
- (b) be so located that the cooling effect that the water from the sprinklers has on the device cannot jeopardize the effective operation of the door or shutter.

B 3.5 Two fire doors may be fitted in the same opening so that the total fire resistance is the sum of their individual fire resistances, provided that each door is capable of closing the opening. Where two fire doors are fitted in the same opening that is provided as a means of escape, one door may be fitted with an automatic self-closing device and be held open by a fusible link if the other door is capable of being easily opened by hand and has at least 30- minute fire resistance.

B4 Insulation

B4.1 Fire doors or shutters often do not provide any significant insulation. Unless a fire door or shutter provides both integrity and insulation in accordance with [Appendix A, Table 31](#), a maximum of 25% of the length of a compartment wall should consist of uninsulated door or shutter openings (see Appendix C, [Diagram 92](#)).

Shutters do not need to have an insulation performance in a shopping centre where shutters are used to separate a shop unit from the mall (see Para [3.4.4.6\(d\)](#)).

B5 Fire Door Hardware

B5.1 Any hinge on which a fire door is hung should be made entirely from materials with a reaction-to-fire classification achieving A1, be tested to I.S. EN 1935 and having a melting point of at least 800°C, unless shown to be satisfactory when tested as part of a fire doorset assembly.

B5.2 Any device installed in accordance with I.S. EN 13637:2015 should have a time delay of Grade 0 (no time delay), and a denied exit mode of Grade 0 (no denied exit).

Appendix B Fire Doors

B6 Fire Safety Signs

B6.1 The following applies to the provision of fire safety signs on fire doors:

- (a) Except for doors identified in (b) below, all fire doors should be provided with an appropriate sign, permanently fixed between 1.6 m and 1.8 m measured vertically from the floor, meeting the following:
 - (i) The sign colour should be in accordance with the provisions for mandatory signs (blue) specified in ISO 3864-1.
 - (ii) The signs should be in accordance with [Diagram 86](#), as appropriate.

Fire doors to cupboards and to service ducts should be marked on the outside. All other fire doors should be marked on both sides.

- (b) The following fire doors are not required to comply with (a) above
 - (i) doors to and within flats or maisonettes;
 - (ii) bedroom doors in other residential (Purpose Group 2(b)) premises; and
 - (iii) lift entrance doors.

B7 Identification

B 7.1 All fire doors installed in a building should be provided with a label giving at least the following information:

- (a) manufacturer (name or contact details, e.g. code or address);
- (b) type and/or name of the product;
- (c) series number or unique reference number of the product;
- (d) fire resistance, smoke control and/or self-closing classification.

Provisions for labelling may also be met by reference to Section 7 of I.S. EN 16034, or equivalent.

The label may be placed on the leading or top edge of the door leaf.



Letter height: 5mm
Sign height 60mm



Letter height: 5mm
Sign height 80mm

Appendix B Fire Doors

Table 36 Provisions for Fire Doors	
Position of door	Minimum fire resistance in terms of integrity (minutes) ⁽¹⁾⁽²⁾⁽³⁾
1. Within a compartment wall:	
(a) (i) if it separates a flat, maisonette or student accommodation unit from a space in common use, (ii) if it separates an open plan flat from a space in common use	E30 Sa E *Sa (max 60)
(b) enclosing a protected shaft forming a stairway situated wholly or partly above the adjoining ground in a building used for flats, or for other residential, assembly and recreation or office purposes	E30 Sa
(c) enclosing a protected shaft forming a stairway not described in (b) above	E + Sa (min 30)
(d) door in a compartment wall used for horizontal evacuation in a residential (care facility) building (excluding hospitals – see Para 1.4.5)	E * Sa (max 60)
(e) not described in (a), (b), (c) or (d) above	E*
2. Within a compartment floor	
3. Forming part of the enclosures (which does not form a protected shaft) of:	
(a) a protected stairway (except where described in item 9 below),	E30 Sa
(b) a lift shaft, or	E30
(c) a service shaft	E30 Sa
4. Forming part of the enclosure of:	
(a) a protected lobby approach (or corridor) to a stairway	E30 Sa
(b) a protected lobby to a firefighting corridor at fire service access level	E 60Sa
(c) any other protected corridor	E30 Sa
5. Affording access to an external escape route	
6. Subdividing:	
(a) corridors connecting alternative exits, or	E30 Sa
(b) dead-end portions of corridors from the remainder of the corridor	E30 Sa
7. Any door within a cavity barrier	
8. Any door:	
(a) forming part of the enclosures to a protected entrance hall or protected stairway in a flat, maisonette, or hall of residence	E30
(b) within any other fire-resisting construction in a flat, maisonette or hall of residence not described elsewhere	E30
9. Firefighting lift landing door to the main lift lobby	
10. Any other door not described above	
Notes:	
* Period of fire resistance (see Table 31 of Appendix A for the wall in which the door is situated	
+ Half the period of fire resistance (see Table 31 of Appendix A) for the wall in which the door is situated, but not less than 30 minutes	
Sa Unless pressurisation techniques complying with I.S. EN 12101-6 are used; these doors should also meet the additional classification requirement of Sa when tested in accordance with I.S. EN 1634-3.	
(1) Method of exposure is from each side separately (except for doors to lift shafts, where the method of exposure is from the landing side only).	
(2) Two fire-resisting doors may be fitted in an opening if each door by itself is capable of closing the opening and the two doors together achieve the required level of fire resistance.	
(3) See also Appendix A, Table 37 , for limitation on use of uninsulated glazed elements.	

Appendix B Fire Doors

Table 37 Limitations on the use of Uninsulated Fire-resisting Glazed Elements on Escape Routes – Doors (see Table 31, Note 10)			
Position of glazed element		Maximum total glazed area in a door leaf in a building with:	
		a single stairway	more than one stairway
1	Within the enclosures to a protected entrance hall or protected landing of a flat or maisonette	Unlimited above 1.1 m	Unlimited above 1.1 m
2	Between residential/sleeping accommodation and a common escape route (corridor, lobby or stairway)	No glazing	No glazing
3	*Between a protected stairway (+) and	25% of door area	50% of door area
	(a) the accommodation, or		
	(b) a corridor which is not a protected corridor		
4	Between*	Unlimited above 0.1 m from floor	Unlimited above 0.1 m from floor
	(a) a protected stairway (+) and a protected lobby or protected corridor		
	(b) the accommodation and a protected lobby		
5	*Between the accommodation and a protected corridor forming a dead end	Unlimited above 1.1 m from floor	Unlimited above 1.1 m from floor
6	*(a) Between the accommodation and any other corridor	N/A	Unlimited above 0.1 m from floor
	(b) Subdividing corridors		
Notes: * But not any such part included in item 2 (+) If the protected stairway is also a protected shaft (see Section 3), or a firefighting stairway (see Section 5), the use of glazed elements may be further restricted.			

Appendix C Methods of Measurement

Appendix C: Methods of Measurement

C1 Methods of Measurement

Some form of measurement is an integral part of many of the provisions in this document.

Diagrams 74 to 78 show how the various forms of measurement should be made, based on definitions in [Subsection 0.10](#).

See Section 1, [Subsection 1.3](#) for methods of measurement specific to means of escape in case of fire.

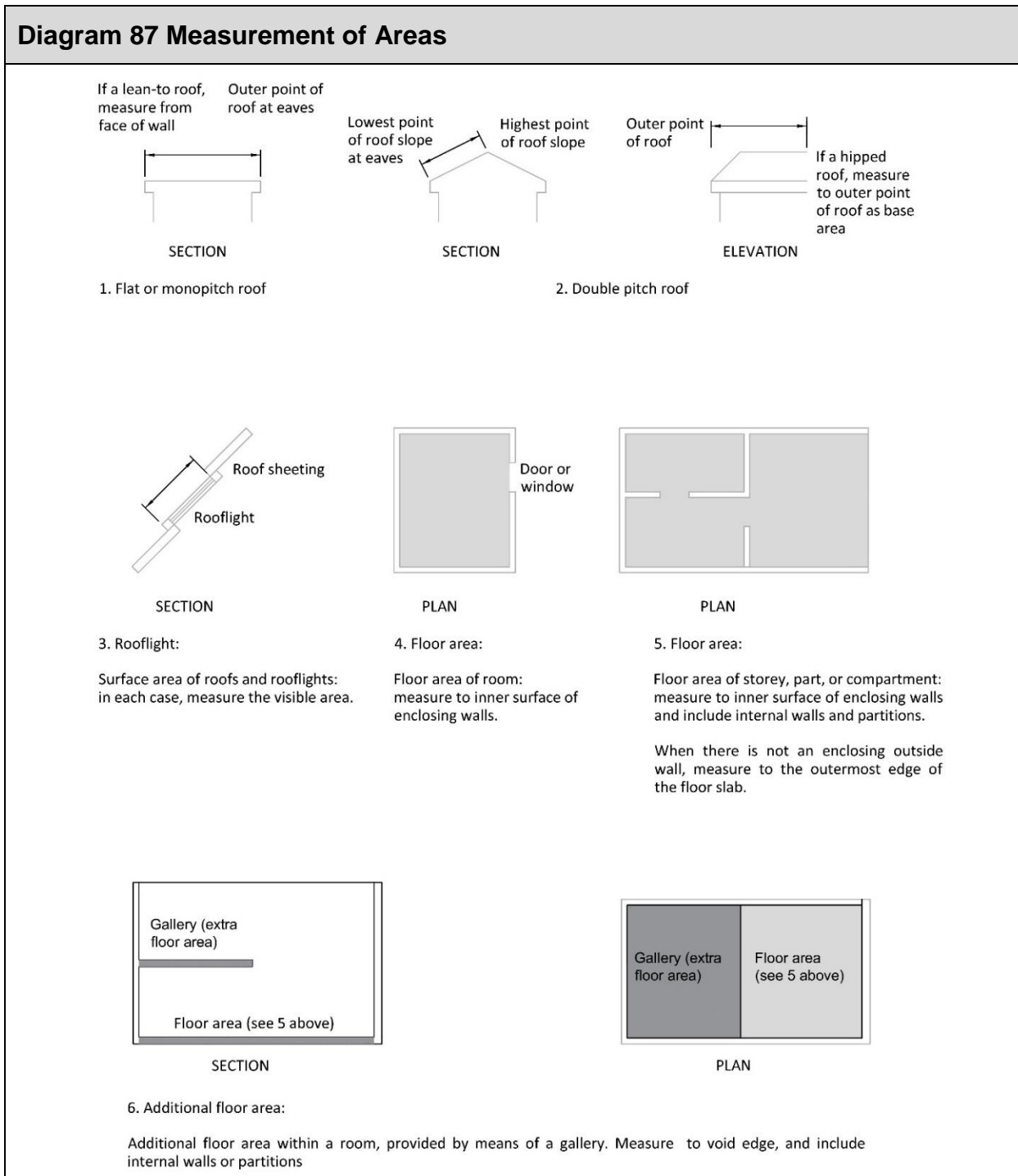

Appendix C Methods of Measurement

Diagram 88 Cubic Capacity

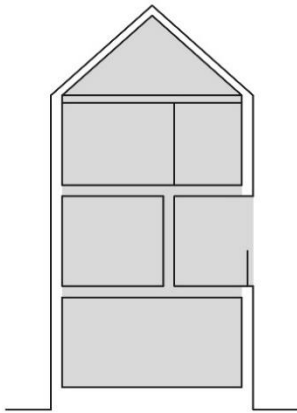

CUBIC CAPACITY OF BUILDING

Measure

- to upper side of lowest floor;
- to lower side of roof;
- to inner surface of enclosing walls or, where there is not an enclosing outside wall, to the outermost edge of the floor.

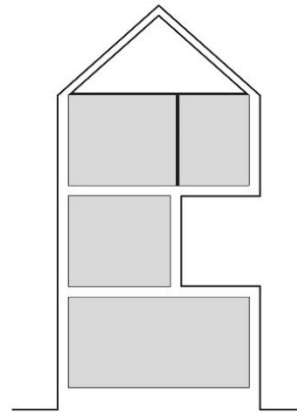

CUBIC CAPACITY OF A COMPARTMENT

Measure

- to upper side of compartment floor below;
- to lower side of compartment floor over; and
- to inner surface of compartment walls.

- Partition
= = = Compartment wall or floor

Diagram 89 Number of Storeys

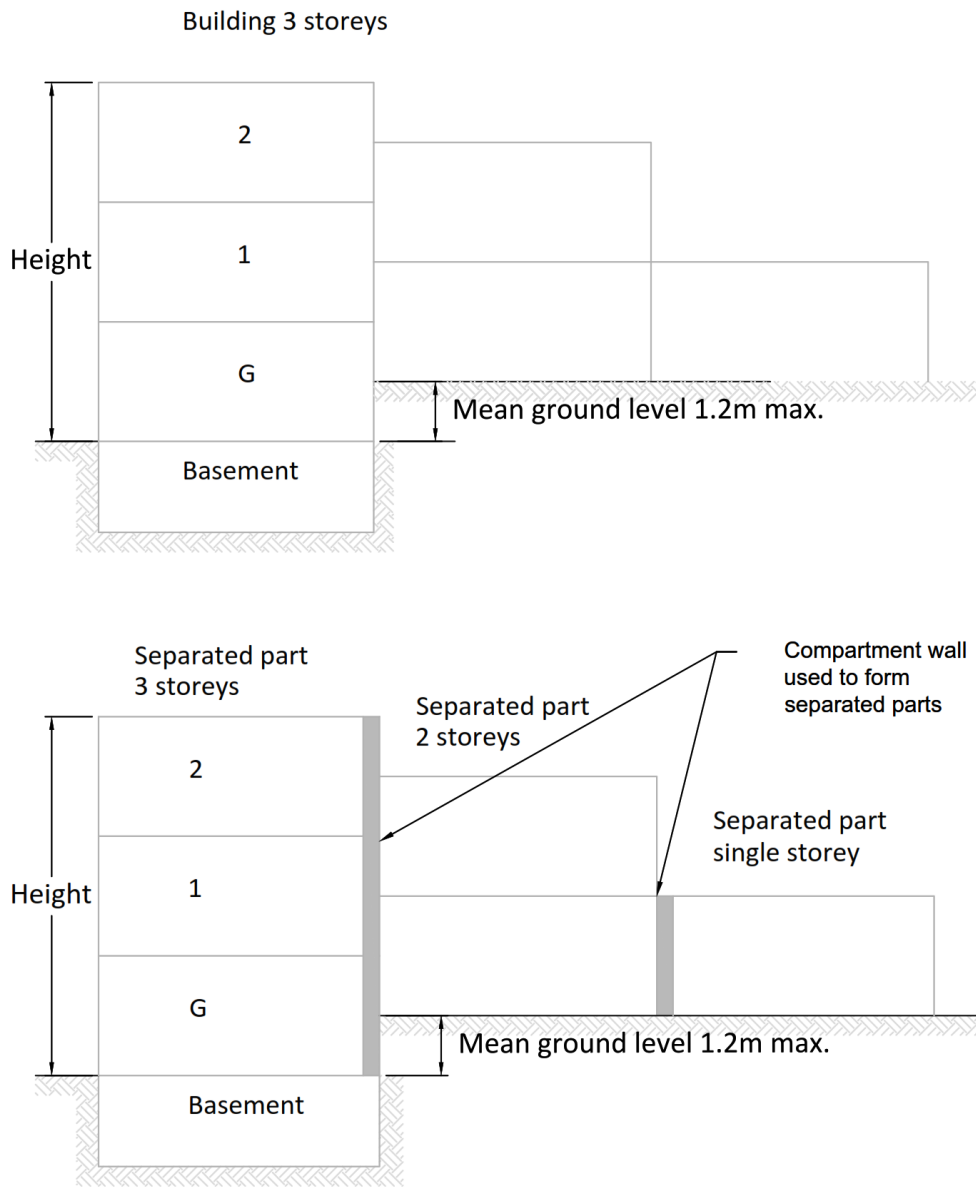

Notes:

- (1) To count the number of storeys in a building or in a separated part of a building count only at the position which gives the greatest number and exclude any basement storeys.
- (2) For definition of storey, see [Subsection 0.10](#).
- (3) For definition of separated part, see [Subsection 0.10](#).

Appendix C Methods of Measurement

Diagram 90 Height of a Building

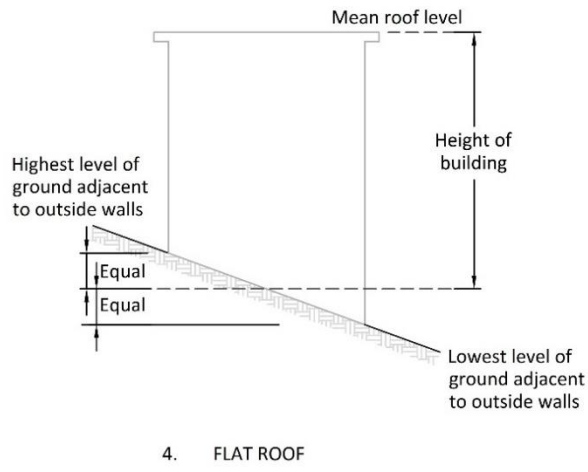
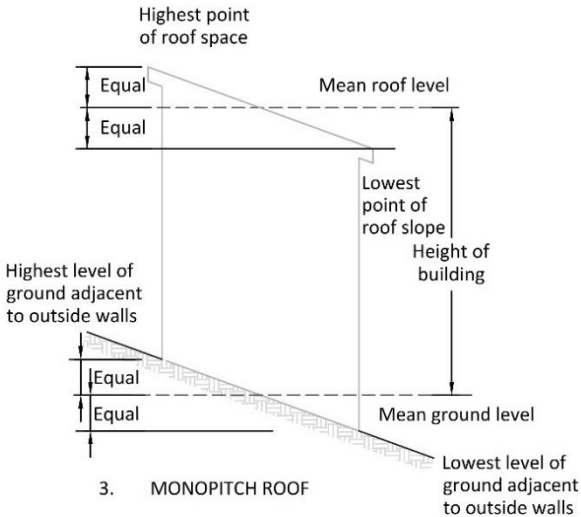
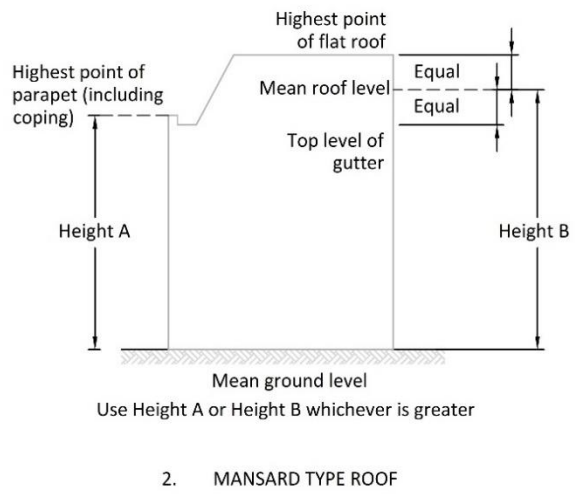
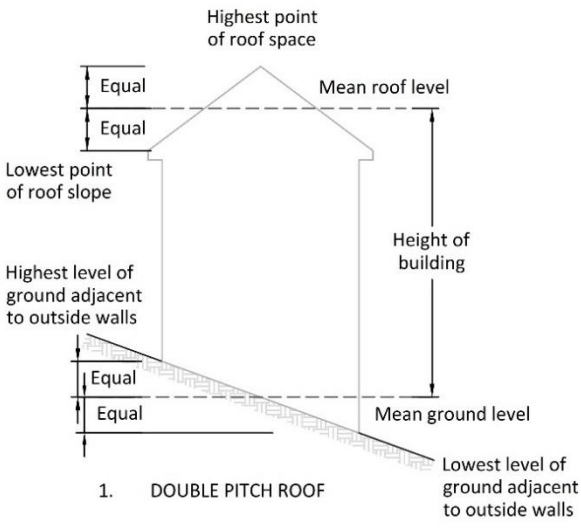
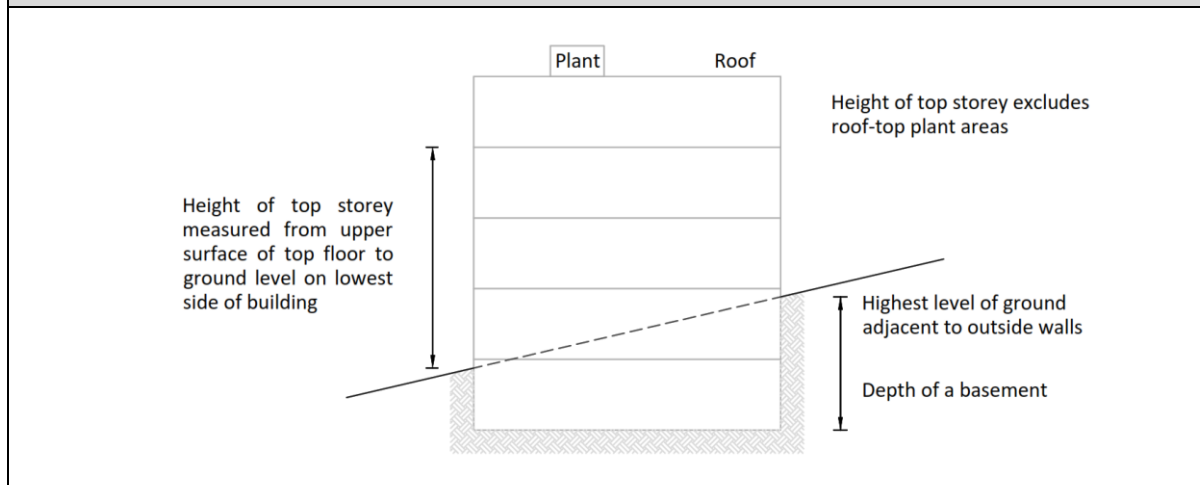
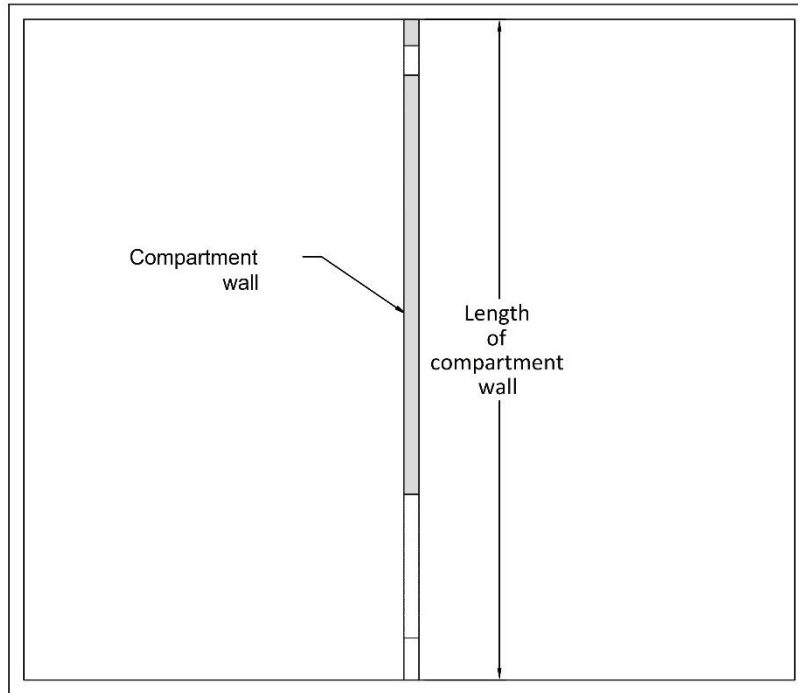

Diagram 91 Height of Top Storey and Depth of a Basement



Appendix C Methods of Measurement

Diagram 92 Length of a Compartment Wall



Compartment walls are measured along the length of the wall. Where a compartment wall meets an external or separating wall, it is measured to the innermost face of the external / separating wall.

Example:

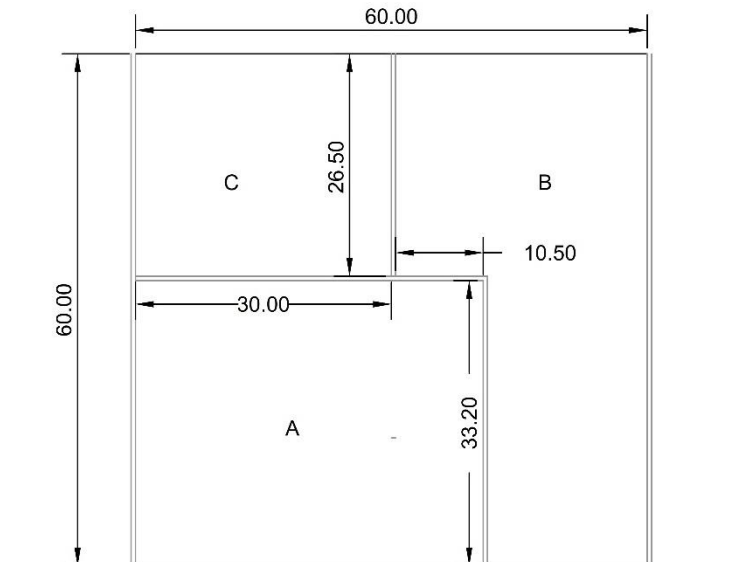

Permitted uninsulated compartment wall formed by fire doors / shutters
 Compartment A - C = $30\text{m} \times 0.25 = 7.5\text{m}$
 Compartment A - B = $(33.20\text{m} + 10.50\text{m}) \times 0.25 = 10.92\text{m}$
 Compartment B - C = $26.50\text{m} \times 0.25 = 6.6\text{m}$

Diagram 93 Atria

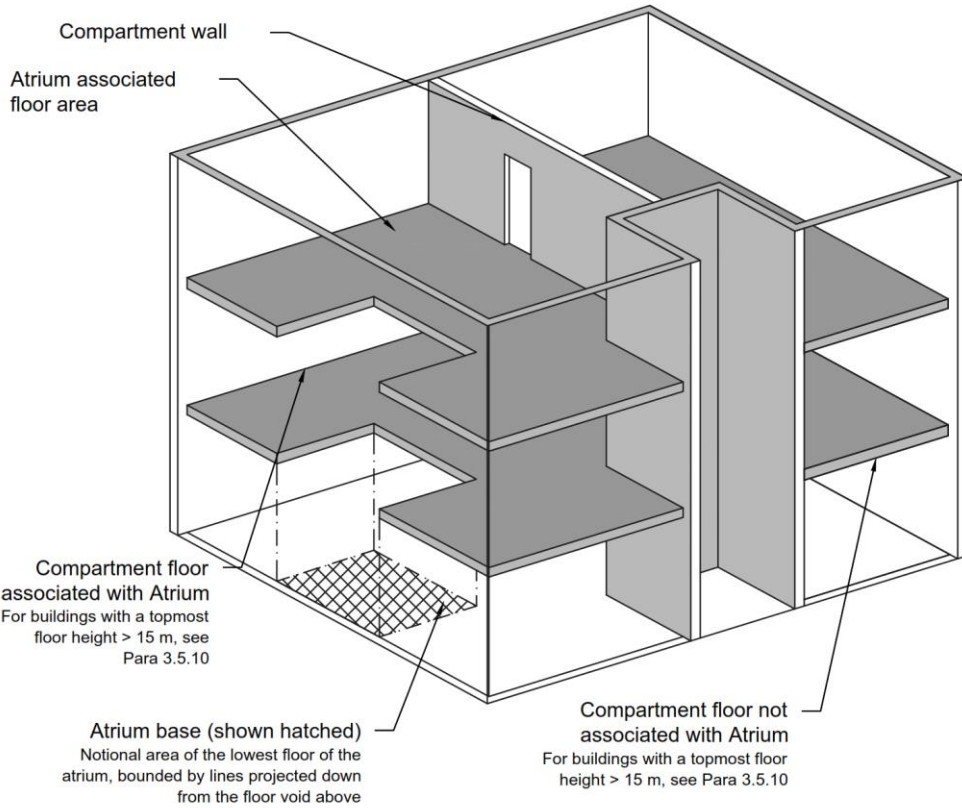
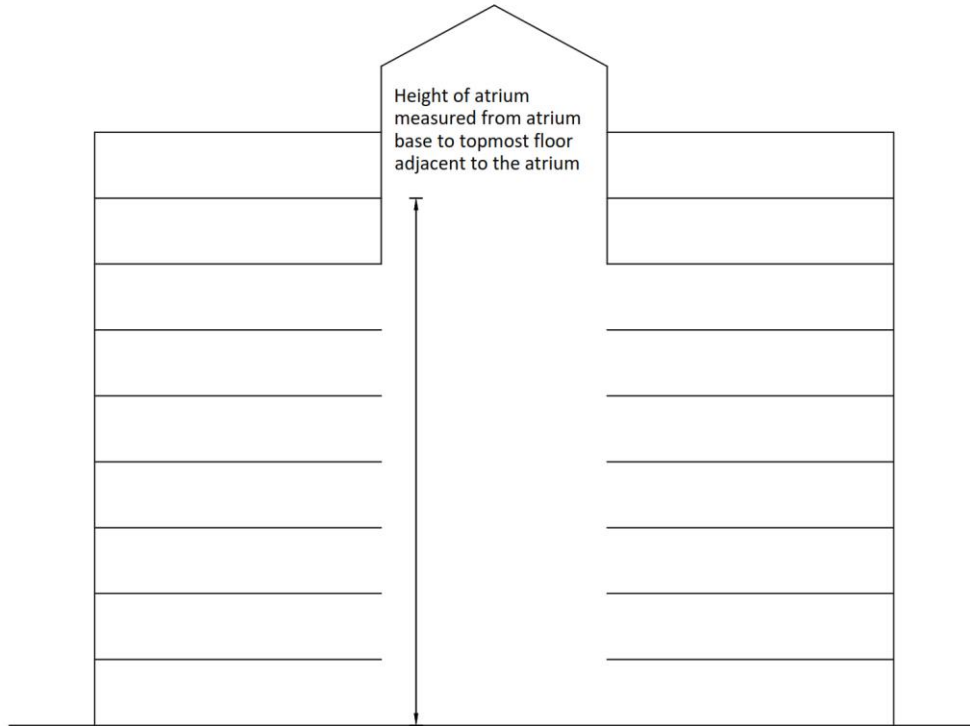

Appendix D: Assessment of Fire Hazard and Associated Life Risk

D1 Assessment of Fire Hazard and Associated Life Risk

As premises covered by this document can vary greatly in size and layout, the risk of fire can also vary considerably from one situation to another, particularly in industrial and storage buildings where widely differing processes may be carried out and hazardous substances are stored or used. It is essential, therefore, that the fire precautions to be provided should be determined having regard to all relevant circumstances.

For the purpose of the guidance in this document, two categories are used for industrial and storage buildings. These categories are as follows:

Industrial (Purpose Group 6)

- (a) Normal Hazard; and
- (b) High Hazard).

Storage (Purpose Group 7)

- (a) Normal Hazard; and
- (b) High Hazard.

For the purpose of the relevant guidance, industrial and storage buildings should be treated as Normal Hazard unless identified, by reasons of the criteria outlined in this Appendix, as being High Hazard.

It should be noted that it is not possible to set out precise rules or other criteria that will be adequate to clearly establish the appropriate use in all cases. It is possible, however, to describe in broad terms the kind of factors which will need to be considered to determine if a building can be described as High Hazard.

The details contained in the following paragraphs should be treated as broad indicators. It does not necessarily follow that the presence (or indeed the absence) of one of the factors mentioned in the description of the High Hazard category inevitably means that the premises or part of the premises have to be placed in that category. It is likely that in many industrial and storage buildings, there will be a mixture of risks. It is emphasised that all factors should be considered.

At the building design stage, it may be difficult to determine the exact nature of the processes or storage involved. However, the basis for the assessment (whether Normal or High Hazard) should always be established in order to provide for adequate safety measures.

Appendix D Assessment of Fire Hazard and Associated Life Risk

D2 Assessment of High Hazard

Factors which lead to the assessment of premises or parts of the premises as being of High Hazard include the following:

- (a) the presence of materials likely, when ignited, to cause the rapid spread of fire, smoke or fumes (The materials may be solid, liquid, or gaseous and as well as in the normal forms may be present as dust, spray, mist or vapour);
- (b) the presence of highly flammable or explosive materials (other than in small quantities);
- (c) certain areas which, due to their function, may present a greater risk of fire occurring and developing than elsewhere, such as manufacturing processes that handle highly flammable liquids;
- (d) the storage of hazardous goods or materials and the storage of vehicles that contain hazardous goods or materials;
- (e) manufacturing, processing, repairing, cleaning, washing, breaking up or otherwise treating any hazardous substance; and
- (f) the presence of unsprinklered racking, where the topmost shelf has a height greater than 7m above floor level.

D3 Hazardous Materials

Materials falling within the following general descriptions should be considered as hazardous materials (other than in small quantities):

- (a) explosives;
- (b) compressed or liquefied gases;
- (c) flammable liquids with a flash point below 65 °C, including whisky or other spirituous liquor;
- (d) substances which become dangerous by interaction with either water or air;
- (e) corrosive substances;
- (f) oxidising agents;
- (g) substances liable to spontaneous combustion;
- (h) substances that change or decompose readily, giving out heat when doing so;
- (i) combustible solid substances with a flash point less than 120 °C; and
- (j) any substance likely to spread fire by flowing from one part of a building to another.

Appendix E Standards and Publications

Appendix E: Standards and Publications

The year designation “xxxx” is used for pending European standards that are not yet published.

E1 National Standards Authority of Ireland

I.S. 10101:2020+ AC1:2020	National Rules for Electrical Installation
I.S. 3217:22023	Emergency Lighting
I.S. 3218:2013+A1:2019	Fire Detection and Alarm Systems for Buildings - System Design, Installation, Commissioning, Servicing and Maintenance & Amendment 1:2019
I.S. 391:2020	Fire Mains for Buildings - Installation, Commissioning, Maintenance and Testing
I.S.440:2009+ A1:2014	Timber Frame Construction, Dwellings and Other Buildings (Including Amendment 1, Consolidated)
I.S. 813 :2014+ A1:2017/AC:2017	Domestic Gas Installations (Edition 3) and Amendment 1:2017
I.S. 820:2019	Non-Domestic Gas Installations (Edition 3)
I.S. EN 81-20:2020	Safety Rules for the Construction and Installation of Lifts - Lifts for the Transport of Persons and Goods - Part 20: Passenger and Goods Passenger Lifts
I.S. EN 81-70:2021	Safety Rules for the Construction and Installation of Lifts - Particular Applications for Passenger and Goods Passenger Lift - Part 70: Accessibility to Lifts for Persons including Persons with Disability
I.S. EN 81-72:2020	Safety Rules for the Construction and Installation of Lifts - Particular Applications for Passenger and Goods Passenger Lift - Part 72: Firefighters Lifts
I.S. EN 771	Specification for Masonry Units
I.S. EN 1125:2008	Building Hardware - Panic Exit Devices Operated by a Horizontal Bar, for Use on Escape Routes - Requirements and Test Methods
I.S. EN 1155:1998/ A1:2002 /AC:2006	Building Hardware - Electrically Powered Hold-Open Devices for Swing Doors - Requirements and Test Methods
I.S. EN 12101- 1:2005	Smoke and Heat Control Systems- Part 1: Specification for Smoke Barriers
I.S. EN 12101- 2:2017	Smoke and Heat Control Systems- Part 2: Natural Smoke and Heat Exhaust Ventilators
I.S. EN 12101- 3:2015	Smoke and Heat Control Systems- Part 3: Specification for Powered Smoke and Heat Control Ventilators (Fans)

Appendix E Standards and Publications

I.S. CEN/TR 12101-5:2005	Smoke and Heat Control Systems- Part 5: Guidelines on Functional Recommendations and Calculation Methods for Smoke and Heat Exhaust Ventilation Systems
I.S. EN 12101-6:2022	Smoke and Heat Control Systems – Part 6: Specification for Pressure Differential Systems - Kits
I.S. EN 12101-8:2011	Smoke and Heat Control Systems – Part 8: Smoke Control Dampers
I.S. EN 12845:2015 +AC:2016+A1:2019	Fixed Firefighting Systems - Automatic Sprinkler Systems - Design, Installation and Maintenance
I.S. EN 13238:2010	Reaction to Fire Tests for Building Products - Conditioning Procedures and General Rules for Selection Of Substrates
I.S. EN 1329-1:2020	Plastics Piping Systems for Soil and Waste Discharge (Low and High Temperature) Within the Building Structure - Unplasticized Poly (Vinyl Chloride) (PVC-U) - Part 1: Specifications for Pipes, Fittings and the System
I.S. EN 13381-7:2019	Test methods for determining the contribution to the fire resistance of structural members Applied protection to timber members
I.S. EN 13501-1:2018	Fire Classification of Construction Products and Building Elements - Part 1: Classification Using Data From Reaction to Fire Tests
I.S. EN 13501-2:2023	Fire Classification of Construction Products and Building Elements - Part 2: Classification Using Data From Fire Resistance Tests, Excluding Ventilation Services
I.S. EN 13501-3:2005+A1:2009	Fire Classification of Construction Products and Building Elements - Part 3: Classification Using Data From Fire Resistance Tests on Products and Elements Used in Building Service Installations: Fire Resisting Ducts and Dampers
I.S. EN 13501-4:2016	Fire Classification of Construction Products and Building Elements - Part 4: Classification Using Data From Fire Resistance Tests on Components of Smoke Control Systems.
I.S. EN 13501-5:2016	Fire Classification of Construction Products and Building Elements - Part 5: Classification Using Data From External Fire Exposure to Roofs Tests
I.S. EN 13637:2015	Building Hardware - Electrically Controlled Exit Systems for Use on Escape Routes - Requirements and Test Methods
I.S. EN 1363-1:2020	Fire resistance tests - Part 1: General Requirements
I.S. EN 1363-2:2000	Fire resistance tests – Part 2: Alternative and Additional Procedures

Appendix E Standards and Publications

EN 1364-1:2015	Fire resistance tests for non-loadbearing elements - Part 1: Walls
EN 1364-2:2018	Fire resistance tests for non-loadbearing elements - Part 2: Ceilings
EN 1364-3:2014	Fire resistance tests for non-loadbearing elements - Part 3: Curtain walling - Full configuration (complete assembly)
EN 1364-4:2014	Fire resistance tests for non-loadbearing elements - Part 4: Curtain walling - Part configuration
EN 1365-1:2012	Fire resistance tests for loadbearing elements - Part 1: Walls
EN 1365-2:2014	Fire resistance tests for loadbearing elements - Part 2: Floors and roofs
EN 1365-3:2000	Fire resistance tests for loadbearing elements - Part 3: Beams
EN 1365-4:2000	Fire resistance tests for loadbearing elements - Part 4: Columns
EN 1365-5:2004	Fire resistance tests for loadbearing elements - Part 5: Balconies and walkways
EN 1365-6:2004	Fire resistance tests for loadbearing elements - Part 6: Stairs
I.S. EN 1366-1:2014+A1:2020	Fire resistance tests for service installations - Part 1: Ventilation ducts
I.S. EN 1366-2:2015	Fire resistance tests for service installations - Part 2: Fire Dampers
I.S. EN 1366-3:2021	Fire Resistance Tests for Service Installations - Part 3: Penetration Seals
I.S. EN 1366-4 :2021	Fire Resistance Tests for Service Installations - Part 4: Linear Joint Seals
I.S. EN 1366-5:2021	Fire resistance tests for service installations - Part 5: Service ducts and shafts
I.S. EN 1366-6:2004	Fire resistance tests for service installations - Part 6: Raised access and hollow core floors
I.S. EN 1935:2002	Building Hardware – Single Axis Hinges – Requirements and Test Methods
I.S. 13637:2015	Building Hardware – Electrically controlled Exit Systems for Use on Escape Routes – Requirements and Test Methods
I.S. EN 13707:2013	Flexible Sheets for Waterproofing - Reinforced Bitumen Sheets for Roof Waterproofing - Definitions and Characteristics
I.S. EN 13823:2020+A1:2022	Reaction to Fire Tests for Building Products - Building Products Excluding Floorings Exposed to the Thermal Attack by a Single Burning Item
I.S. EN 14604:2005	Smoke Alarm Devices
I.S. EN 15423:2008	Ventilation for Buildings - Fire Precautions for Air Distribution Systems in Buildings

Appendix E Standards and Publications

I.S. EN 15650:2010	Ventilation for Buildings - Fire Dampers
I.S. EN 15725:2023	Extended Application Reports on the Fire Performance Of Construction Products and Building Elements
I.S. EN 16005:2023	Power Operated Pedestrian Doorsets - Safety in Use - Requirements and Test Methods
I.S. EN 16034:2014	Pedestrian Doorsets, Industrial, Commercial, Garage Doors and Openable Windows - Product Standard, Performance Characteristics - Fire Resisting and/or Smoke Control Characteristics
I.S. EN 1634-1:2014+A1:2018	Fire Resistance and Smoke Control Tests for Door and Shutter Assemblies, Openable Windows and Elements of Building Hardware – Part 1: Fire Resistance Test for Door and Shutter Assemblies and Openable Windows
I.S. EN 1634-2:2008	Fire Resistance and Smoke Control Tests for Door and Shutter Assemblies, Openable Windows and Elements of Building Hardware – Part 2: Fire Resistance Characterisation Test for Elements of Building Hardware.
I.S. EN 1634-3:2004	Fire Resistance and Smoke Control Tests for Door and Shutter Assemblies, Openable Windows and Elements of Building Hardware – Part 3: Smoke Control Test for Door and Shutter Assemblies
I.S. EN 16925:2018& LC:2018&AC:2020	Fixed Firefighting Systems - Automatic Residential Sprinkler Systems - Design, Installation and Maintenance
I.S. EN 179:2008	Building Hardware - Emergency Exit Devices Operated by a LeverHandle or Push Pad, for Use on Escape Routes - Requirements and Test Methods
I.S. EN 1990:2002 + NA:2010	Eurocode 0: Basis of Structural Design (Including Irish National Annex)
I.S. EN 1991-1-2:2002	Eurocode 1: Actions on Structures - Part 1-2: General Actions - Actions on Structures Exposed to Fire
I.S. EN 1992-1-2:2004 & AC:2008 & A1:2019	Eurocode 2: Design of Concrete Structures - Part 1-2: General Rules - Structural Fire Design
I.S. EN 1993-1-2:2005	Eurocode 3: Design of Steel Structures - Part 1-2: General Rules Structural Fire Design (Including Irish National Annex)
I.S. EN 1994-1-2:2005	Eurocode 4 - Design of Composite Steel and Concrete Structures -Part 1-2: General Rules - Structural Fire Design (Including Irish National Annex)
I.S. EN 1995-1-2:2005	Eurocode 5: Design of Timber Structures - Part 1-2: General - Structural Fire Design (Including Irish National Annex)

Appendix E Standards and Publications

I.S. EN 1996-1-2:2005	Eurocode 6 - Design of Masonry Structures - Part 1-2: General Rules - Structural Fire Design (Including Irish National Annex)
I.S. EN 1999-1-2:2007	Eurocode 9 - Design of Aluminium Structures - Part 1-2: Structural Fire Design (Including Irish National Annex)
I.S. EN 54-3:2014+A1:2019	Fire Detection and Alarm Systems - Part 3: Fire Alarm Devices – Sounders
I.S. EN 54-11:2001	Fire Detection and Alarm Systems - Part 11: Manual Call Points
I.S. EN 60669-2-6:2012	Switches for Household and Similar Fixed Electrical Installations - Part 2-6: Particular Requirements - Fireman's Switches for Exterior and Interior Signs and Luminaires
I.S. EN 671-1:2012	Fixed Firefighting Systems - Hose Systems - Part 1: Hose Reels With Semi-Rigid Hose
I.S. EN 81-20 :2020	Safety Rules for the Construction and Installation of Lifts - Lifts for the Transport of Persons and Goods - Part 20: Passenger and Goods Passenger Lifts
I.S. EN 81-70:2021+A1:2022	Safety Rules for the Construction and Installation of Lifts - Particular Applications for Passenger and Goods Passenger Lift - Part 70: Accessibility to Lifts for Persons Including Persons With Disability
I.S. EN 81-72:2020	Safety Rules for the Construction and Installation of Lifts - Particular Applications for Passenger and Goods Passenger Lifts - Part 72: Firefighters Lifts
I.S. EN IEC 60947-3:2021 & AC:2021-11	Low-Voltage Switchgear and Control gear - Part 3: Switches, Disconnectors, Switch Disconnectors And Fuse-Combination Units
I.S. EN ISO 1182:2020	Reaction to Fire Tests for Products - Non-Combustibility Test
I.S. EN ISO 11925-2:2020	Reaction to Fire Tests - Ignitability of Products Subjected to Direct Impingement of Flame - Part 2: Single-Flame Source Test
I.S. EN ISO 1716:2018	Reaction to Fire Tests for Products - Determination of the Gross Heat of Combustion (Calorific Value)
I.S. EN ISO 306:2022	Plastics - Thermoplastic Materials - Determination of Vicat Softening Temperature (VST)
I.S. EN ISO 7010:2020/A6 2023	Graphical Symbols - Safety Colours and Safety Signs - Registered Safety Signs
I.S. EN ISO 9239-1:2010	Reaction to Fire Tests for Floorings - Part 1: Determination of the Burning Behaviour Using a Radiant Heat Source
S.R. 325:2013 +A2:2018+AC:2019	Recommendations for the design of masonry structures in Ireland to Eurocode 6.

E2 British Standards Institution

BS 2782-0:2011	Methods of Testing Plastic - Introduction
BS 3251:1976	Indicator Plates for Fire Hydrants and Emergency Water Supplies
BS 336:2010	Specification for Fire Hose Couplings and Ancillary Equipment
BS 4514:2001	Unplasticized PVC Soil and Ventilating Pipes of 82.4 mm Minimum Mean Outside Diameter, and Fittings and Accessories of 82.4 mm and of Other Sizes. Specification
BS 476	Fire Tests on Building Materials and Structures
BS 476-11:1982	Fire Tests on Building Materials and Structures - Method for Assessing the Heat Emission From Building Materials
BS 476-20:1987	Fire Tests on Building Materials and Structures - Method for Determination of the Fire Resistance of Elements of Construction (General Principles)
BS 476-21:1987	Fire Tests on Building Materials and Structures - Methods for Determination of the Fire Resistance Of Loadbearing Elements of Construction
BS 476-22:1987	Fire Tests on Building Materials and Structures - Method for Determination of the Fire Resistance of Non-Loadbearing Elements of Construction
BS 476-23:1987	Fire Tests on Building Materials and Structures - Methods for Determination of the Contribution of Components to the Fire Resistance of a Structure
BS 476-24:1987	Fire Tests on Building Materials and Structures - Method for Determination of the Fire Resistance of Ventilation Ducts
BS 476-3:2004	Fire Tests on Building Materials and Structures - Classification and Method of Test for External Fire Exposure to Roofs
BS 476-31-1:1983	Fire Tests on Building Materials and Structures. Methods for Measuring Smoke Penetration Through Doorsets and Shutter Assemblies. Method Of Measurement Under Ambient Temperature Conditions
BS 476-4:1970	Fire Tests on Building Materials and Structures - Non-Combustibility Test for Materials
BS 476-6 :1989 +A1:2009	Fire Tests on Building Materials and Structures - Method of Test for Fire Propagation for Products
BS 476-7:1997	Fire Tests on Building Materials and Structures - Method of Test to Determine the Classification of the Surface Spread of

Appendix E Standards and Publications

	Flame of Products
BS 5234-2:1992	Partitions (Including Matching Linings) Specification for Performance Requirements for Strength and Robustness Including Methods of Test
BS 5255:1989	Specification for Thermoplastics Waste Pipe and Fittings
BS 5268-4-2:1990	Structural use of timber — Part 4: Fire resistance of timber structures — Section 4.2: Recommendations for calculating fire resistance of timber stud walls and joisted floor constructions
BS 5395-2 :1984	Stairs, Ladders and Walkways. Code of Practice for the Design of Helical And Spiral Stairs
BS 5395-3:1985	Stairs, Ladders and Walkways. Code of Practice for the Design of Industrial Type Stairs, Permanent Ladders and Walkways
BS 5410-2:2018	Code of Practice for Liquid Fuel Firing. Installations providing space heating, hot water and steam supply services to non-domestic buildings
BS 5499	Graphical symbols and signs
BS 5839-9:2021	Fire Detection and Alarm Systems for Buildings. Code of Practice for the Design, Installation, Commissioning and Maintenance of Emergency Voice Communication Systems
BS 5906:2005	Waste Management in Buildings - Code of Practice
BS 6180:2011	Barriers in and About Buildings. Code of Practice
BS 7157:1989	Method of Test for Ignitability of Fabrics Used in the Construction of Large Tented Structures
BS 7346-4:2003	Components for Smoke and Heat Control Systems – Part 4: Functional Recommendations and Calculation Methods for Smoke and Heat Exhaust Ventilation Systems, Employing Steady-State Design Fires. Code of Practice
BS 8217:2005	Reinforced Bitumen Membranes For Roofing - Code of Practice
BS 8300:2009+A1:2010	Design of Buildings and their Approaches to Meet the Needs of Disabled People. Code of Practice
BS 8414-1:2020	Fire Performance of External Cladding Systems - Test Method for Non-Loadbearing External Cladding Systems Fixed to, and Supported by, a Masonry Substrate
BS 8414-2:2020	Fire Performance of External Cladding Systems. Test Method for Non-Loadbearing External Cladding Systems Fixed to, And Supported by, a Structural Steel Frame

Appendix E Standards and Publications

BS 9251:2021	Fire Sprinkler Systems for Domestic and Residential Occupancies. Code of Practice
--------------	---

E3 International Standards Organisation

ISO 3864-1:2011	Graphical Symbols - Safety Colours and Safety Signs - Part 1: Design Principles for Safety Signs and Safety Markings
-----------------	--

E4 Building Research Establishment (BRE)

BR 128:1988	Guidelines for the Construction of Fire-Resisting Structural Elements (1988)
BR 135:2013	Fire Performance of External Thermal Insulation for Walls Of Multistorey Buildings (2013)
BR 186:1990	Design Principles for Smoke Ventilation in Enclosed Shopping Centres (1990)
BR 187:2014	External Fire Spread: Building Separation and Boundary Distances (2014)
BR 274:1994	Fire Safety Of PTFE-Based Materials Used in Buildings (1994)
BR 368 :1999	Design Methodologies for Smoke and Heat Exhaust Ventilation (1999)
BR 223	Mathematical Fire Modelling and its Application to Fire Safety Design (1992)
BRE Digest 367	Fire Modelling
BR 258	Design Approaches for Smoke Control in Atrium Buildings (1994)
BRE Digest 208	Increasing the Fire Resistance of Existing Timber Floors (1988)

Appendix E Standards and Publications

E5 Technical Guidance Documents

Technical Guidance Document D	Materials and Workmanship
Technical Guidance Document J	Heat Producing Appliances
Technical Guidance Document K	Stairways, Ladders, Ramps and Guards
Technical Guidance Document M	Access and Use

E6 National Directorate for Fire and Emergency management Publications

Guide to fire Precautions in Existing Hotels, Guesthouses and Similar Premises
Guide to Fire Safety in Guest Accommodation
Guide to Fire Safety in Existing Nursing Homes and Similar Type Premises
Fire Safety in Hostels
Guide to Fire Safety in Flats, Bedsitters and Apartments
Fire Safety in Pre-Schools

E7 Publications Referred to

Architectural Heritage Protection Guidelines for Planning Authorities
Code of Practice for Safety at Sports Grounds, Department of Education and Skills (1992)
Fire Protection in Old Buildings and Historic Town Centres, (UK) Fire Protection Association, 1992
Fire Protection Measures for the Royal Palaces (The Bailey Report), Department of National Heritage (UK), 1993
Guide to Fire Safety at Sports Grounds (Green Guide), Sports Grounds Safety Authority.
Guide for Practitioners 6: Conversion of Traditional Buildings. Scottish Government (2010).
Heritage Under Fire: A Guide to the Protection of Historic Buildings, United Kingdom Working Party on Fire Safety in Historic Buildings, 1995
Firecode Health Technical Memorandum 05-02: Guidance in Support of Functional Provisions for Healthcare Premises, NHS, 2015
Firecode Health Technical Memorandum 05-03, Part B, Fire Detection and Alarm Systems, NHS, 2006
Single Storey Steel Frame Buildings in Fire Boundary Conditions, Steel Construction Institute, 2002
Fire Grading of Buildings: Part 1: General Principles and Structural Precautions. Post-War Building Studies No. 20, HMSO, 1946
Fire Protection for Structural Steel in Buildings, Association for Specialist Fire Protection, Third Edition, 2002
Wood Information Sheet 1-32. Upgrading Timber Doorsets for Fire Resistance. TRADA

Appendix F Other Standards and Publications

Appendix F: Other Standards and Publications

F1 National Directorate for Fire and Emergency Management Publications

Code of Practice for the Management of Fire Safety in Places of Assembly

Code of Practice for Safety in Indoor Concerts

Code of Practice for Fire Safety of Furnishings and Fittings in Places of Assembly

F2 Statutory Instruments

S.I. No. 249 of 1985 Fire Safety in Places of Assembly (Ease of Escape) Regulations

S.I. No. 299 of 2007 Safety, Health and Welfare at Work (General Application) Regulations, 2007

S.I. No. 415 of 2013 Health Act 2007 (Care and Welfare of residents in Designated Centres for older People) Regulations 2013 - 2023

S.I. No. 367 of 2013 Health Act 2007 (Care and Support of residents in designated centres (Children and Adults) with Disabilities) Regulations 2013

S.I. No. 634 of 2017 Health Act 2007 (Care and welfare of children in Special Care Units) Regulations 2017

F3 Acts of the Oireachtas

Fire Services Acts, 1981 and 2003

Licensing of Indoor Events Act, 2003

Safety, Health and Welfare at Work Act, 2005

F4 Fire Modelling

Fire Models: A Guide for Fire Prevention Officers (Home Office Fire Research and Development Group Publication Number 6/93)

F5 Fire Doors and Shutters

Rules for the Construction and Installation of Firebreak Doors and Shutters, Loss Prevention Council (UK), 1988

Hardware for Timber and Escape Doors 2000, The Builders Hardware Industry Federation, 2000

Code of Practice for Fire Resisting Metal Doorsets, Door and Hardware Federation, 1999

Fire-Resisting Doorsets: Maintaining Performance under the New European Test Standard, Timber Research and Development Association, Revised Edition, 2018

F6 Passive Fire Protection

Ensuring Best Practice for Passive Fire Protection (PFP) Systems in Buildings,
Association of Specialist Fire Protection, 2nd edition, 2014

Appendix G: Other Design Documents

Appendix G: Other Design Documents

CIBSE Guide E Fire Safety Engineering of Structures, Chartered Institution of Building Services Engineers, 2019

The SFPE Handbook of Fire Protection Engineering, Society of Fire Protection Engineers, 5th Edition, 2016

BS 9991:2015 Fire safety in the design, management and use of residential buildings. Code of practice. British Standards Institution.

BS 9999:2017 Fire safety in the design, management and use of buildings - code of practice British Standards Institution.

BS 7974:2019 Application of fire safety engineering principles to the design of buildings. Code of practice. British Standards Institution.

Appendix H: Summary of Requirements at Height



Building Height	Single Storey	Topmost floor ≤ 5 m	Topmost floor > 5 m, ≤ 11 m	Topmost floor > 11 m, ≤ 15 m
Min. no of Stairways	N/A	PG 2(a): 2 Stairways (i) All other PG's: 1 (i)	PG 2(a), 5(a), 5(b): 2 Stairways (i) All other PG's: 1 (i)	PG 2(a), 2(b), 3, 4, 5, 6, 7, 8: 2 Stairways (i) PG 1(c): 1(i)
Compartment wall and floor RtF classification	PG 2(a): A2-s3,d2 (walls only)	PG 2(a): A2-s3,d2 (vi, vii) All other PG's: No requirement	PG 2(a): A2-s3,d2 (vi, vii) All other PG's: No requirement	All PG's: A2-s3,d2 (vi, vii)
External wall < 1 m to Boundary RtF classification	PG 2a, 2b, 3, 4, 5, 6, 7, 8: B-s3,d2 (ii) PG 1c: N/A	PG 2a: Class B-s3,d2 (ii) PG 1c, 2b, 5: B-s3,d2 (ii) PG 3, 4, 6, 7, 8: B-s3,d2 (ii)	PG 2a: B-s3,d2(ii) PG 1c, 2b, 5: B-s3,d2(ii) PG 3, 4, 6, 7, 8: B-s3,d2(ii)	PG 2a: B-s3,d2(ii) PG 1c, 2b, 5: B-s3,d2 PG 3, 4, 6, 7, 8: B-s3,d2(ii)
External wall > 1 m to Boundary RtF classification	PG 2a, 2b, 3, 4, 5, 6, 7, 8: No Requirement PG 1c: N/A	PG 2a: B-s3,d2(ii) PG 1c, 2b, 5: C-s3,d2 (ii) PG 3, 4, 6, 7, 8: C-s3,d2 (ii)	PG 2a: B-s3,d2 (ii) PG 1c, 2b, 5: C-s3,d2(ii) PG 3, 4, 6, 7, 8: C-s3,d2(ii)	PG 2a: B-s3,d2(ii) PG 1c, 2b, 5: C-s3,d2(ii) PG 3, 4, 6, 7, 8: C-s3,d2(ii)
Firefighter access	All PG's: Perimeter access based on floor area & volume	All PG's: Perimeter access based on floor area & volume	All PG's: Perimeter access based on floor area & volume	PG 1(c), 2(a), 2(b), Protected stair and firefighting main All other PG's: Perimeter access based on floor area & volume
Sprinklers	PG 4(b): Throughout (iv) All other PG's: N/A(v)	PG 2(a), PG 4(b): Throughout (iv) All other PG's: N/A(v)	PG 2(a), PG 4(b): Throughout (iv) All other PG's: N/A(v)	PG 2(a), PG 4(b): Throughout (iv) All other PG's: N/A(v)
Other		External escape stairways permitted in limited circumstances	External escape stairways permitted in limited circumstances	External escape stairways not permitted (vi)
(i) Additional stairways may be required to satisfy escape requirements for travel distance, occupant capacity, etc. (ii) Applicable only to the outermost wall element. (iii) Applicable to the whole wall build-up. (iv) Sprinklers are not required in sterile mall areas of a shopping centre (v) Sprinklers may be required due to other provisions of this document (vi) For existing buildings, see Section 7 (vii) For certain walls and floors in a shopping centre, see Subsection 1.7				

Appendix H Summary of Requirements at Height

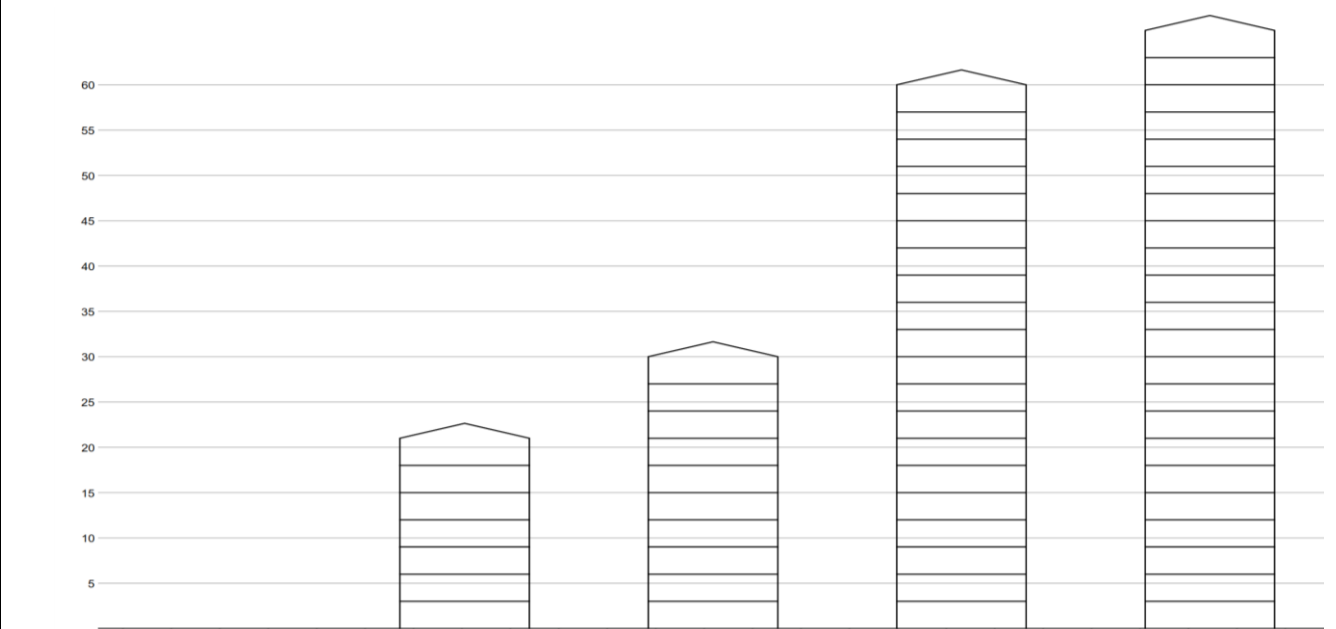

Building Height	Topmost floor > 15 m, ≤ 20 m	Topmost floor > 20 m, ≤ 30 m	Topmost floor > 30 m, < 60 m	Topmost floor > 60 m
Min. no of Stairways	PG 2(a), 2(b), 3 - 8: 2 Stairways (i) PG 1(c): 1(i)	PG 2(a), 2(b), 3 - 8: 2 Stairways (i) PG 1(c): 1(i)	PG 2(a), 2(b), 3 - 8: 2 Stairways (i) PG 1(c): 1(i)	Outside the scope of TGD B
Compartment wall and floor RtF classification	All PG's: A2-s3,d2 (vi, vii)	All PG's: A2-s3,d2 (vi, vii)	All PG's: A2-s3,d2 (vi, vii)	
External wall < 1 m to Boundary RtF classification	PG 1c, 2a, 2b, 5: A2-s3,d2 (iii) PG 3, 4, 6, 7,8: B-s3,d2 (iii)	PG 1c, 2a, 2b, 5: A2-s3,d2 (iii) PG 3, 4, 6, 7,8: B-s3,d2 (iii)	PG 1c, 2a, 2b, 5: A2-s3,d2 (iii) PG 3, 4, 6, 7,8: B-s3,d2 (iii)	
External wall > 1 m to Boundary RtF classification	PG 1c, 2a, 2b, 5: A2-s3,d2 (iii) PG 3, 4, 6, 7,8: B-s3,d2 (iii)	PG 1c, 2a, 2b, 5: A2-s3,d2 (iii) PG 3, 4, 6, 7,8: B-s3,d2 (iii)	PG 1c, 2a, 2b, 5: A2-s3,d2 (iii) PG 3, 4, 6, 7,8: B-s3,d2(iii)	
Firefighter access	PG 1(c), 2(a), 2(b), Protected stair and firefighting main All other PG's: Perimeter access based on floor area & volume	All PG's: Firefighting Shaft	All PG's: Firefighting Shaft	
Sprinklers	PG 1(c), PG 2(a), PG 4(b): Throughout (iv) All other PG's: N/A(v)	PG 1(c), PG 2(a), PG 4(b): Throughout (iv) All other PG's: N/A (v)	PG 1(c), PG 2(a), 3, 4(a), 4(b), 5, 6, 7, 8: Throughout(iv) PG 1(c), 2(b): N/A(v)	
Other	External escape stairways not permitted (vi)	Discounting of stairways required (excl. PG 3, 4(a)) Lobbies to stairways required External escape stairways not permitted (vi)	Discounting of stairways required (excl. PG 3, 4(a)) Lobbies to stairways required External escape stairways not permitted (vi)	

gov.ie/housing

The Department of
Housing, Local Government and Heritage



Rialtas na hÉireann
Government of Ireland